



**PRISM MPI and MPX
SDI / IP Waveform Monitor
User Manual**

Copyrights and Trademark Notices

Copyright © 2021 Telestream, LLC and its Affiliates. All rights reserved. TELESTREAM is a registered trademark of Telestream, LLC. All other trade names referenced are the service marks, trademarks, or registered trademarks of their respective companies.

Telestream products are covered by U.S. and foreign patents, issued and pending. Information in this publication supersedes that in all previously published material. Specifications and price change privileges reserved.

TELESTREAM is a registered trademark of Telestream, LLC.

Blender: Images from Big Buck Bunny used without modification under the Creative Commons Attribution 3.0 license. (c) copyright 2008, Blender Foundation / <http://peach.blender.org/about/>.

Dolby: Dolby and the double-D symbol are registered trademarks of Dolby Laboratories.

Warranty

Telestream on behalf of itself and its Affiliates (“Telestream”) warrants that this product will be free from defects in materials and workmanship for a period of one (1) year from the date of shipment. If any such product proves defective during this warranty period, Telestream, at its option, either will repair the defective product without charge for parts and labor, or will provide a replacement in exchange for the defective product. Parts, modules and replacement products used by Telestream for warranty work may be new or reconditioned to like new performance. All replaced parts, modules and products become the property of Telestream.

In order to obtain service under this warranty, Customer must notify Telestream of the defect before the expiration of the warranty period and make suitable arrangements for the performance of service. Customer shall be responsible for packaging and shipping the defective product to the service center designated by Telestream, with shipping charges prepaid. Telestream shall pay for the return of the product to Customer if the shipment is to a location within the country in which the Telestream service center is located. Customer shall be responsible for paying all shipping charges, duties, taxes, and any other charges for products returned to any other locations.

This warranty shall not apply to any defect, failure or damage caused by improper use or improper or inadequate maintenance and care. Telestream shall not be obligated to furnish service under this warranty a) to repair damage resulting from attempts by personnel other than Telestream representatives to install, repair or service the product; b) to repair damage resulting from improper use or connection to incompatible equipment; c) to repair any damage or malfunction caused by the use of non- Telestream supplies; or d) to service a product that has been modified or integrated with other products when the effect of such modification or integration increases the time or difficulty of servicing the product.

THIS WARRANTY IS GIVEN BY TELESTREAM WITH RESPECT TO THE PRODUCT IN LIEU OF ANY OTHER WARRANTIES, EXPRESS OR IMPLIED. TELESTREAM AND ITS VENDORS

DISCLAIM ANY IMPLIED WARRANTIES OF MERCHANTABILITY OR FITNESS FOR A PARTICULAR PURPOSE. TELESTREAM'S RESPONSIBILITY TO REPAIR OR REPLACE DEFECTIVE PRODUCTS IS THE SOLE AND EXCLUSIVE REMEDY PROVIDED TO THE CUSTOMER FOR BREACH OF THIS WARRANTY. TELESTREAM AND ITS VENDORS WILL NOT BE LIABLE FOR ANY INDIRECT, SPECIAL, INCIDENTAL, OR CONSEQUENTIAL DAMAGES IRRESPECTIVE OF WHETHER TELESTREAM OR THE VENDOR HAS ADVANCE NOTICE OF THE POSSIBILITY OF SUCH DAMAGES.

[W2 – 15AUG04]

TELESTREAM SOFTWARE LICENSE AGREEMENT

THE PROGRAM, OR PROGRAMS, ENCODED OR INCORPORATED WITHIN EQUIPMENT OR ACCOMPANYING THIS AGREEMENT, IS FURNISHED SUBJECT TO THE TERMS AND CONDITIONS OF THIS AGREEMENT. RETENTION OF THE PROGRAM FOR MORE THAN THIRTY DAYS OR USE OF THE PROGRAM IN ANY MANNER WILL BE CONSIDERED ACCEPTANCE OF THE AGREEMENT TERMS. IF THESE TERMS ARE NOT ACCEPTABLE, THE UNUSED PROGRAM AND ANY ACCOMPANYING DOCUMENTATION SHOULD BE RETURNED PROMPTLY TO TELESTREAM FOR A FULL REFUND OF THE

LICENSE FEE PAID. (FOR INFORMATION REGARDING THE RETURN OF PROGRAMS ENCODED OR INCORPORATED WITHIN EQUIPMENT, CONTACT THE NEAREST TELESTREAM SALES OFFICE.)

DEFINITIONS

"Telestream" means Telestream, LLC, a Delaware limited liability company, and its Affiliates, or the local Telestream legal entity that is supplying the equipment.

"Program" means the Telestream software product (executable program and/or data) enclosed with this Agreement or included within the equipment with which this Agreement is packed. "Customer" means the person or organization in whose name the Program was ordered.

LICENSE

Customer may:

1. Use the Program on a single machine at any one time; and
2. Copy the Program for archival or backup purposes, provided that no more than one (1) such copy is permitted to exist at any one time. Each copy of the Program made by Customer must include a reproduction of any copyright notice or restrictive rights legend appearing in or on the copy of the Program as received from Telestream.

Customer may not:

1. Use the Program on more than one machine at any one time;
2. Transfer the Program to any person or organization outside of Customer or the corporation of which Customer is a part without the prior written consent of Telestream, except in connection with the transfer of the equipment within which the programs are encoded or incorporated;

3. Export or re-export, directly or indirectly, the program, any associated documentation, or the direct product thereof, to any country to which such export or re-export is restricted by law or regulation of the United States or any foreign government having jurisdiction without the prior authorization, if required, of the Office of Export Administration, Department of Commerce, Washington, D.C. and the corresponding agency of such foreign government;
4. Modify the Program, create derivative works, or merge the Program with another program;
5. Reverse compile or disassemble the Program for any purpose, beyond the extent that such activity is expressly permitted by applicable open source licenses or applicable law notwithstanding this limitation; or
6. Copy the documentation accompanying the Program.

For Programs designed to reside on a single-machine and support one or more additional machines, either locally or remotely, without permitting the Program to be transferred to an additional machine for local execution, the additional machines shall be considered within the definition of "single machine." For programs permitting the Program to be transferred to an additional machine for local execution, a separate license shall be required for each such machine with which the Program may be used. Title to the Program and all copies thereof, but not the media on which the Program or copies may reside, shall be and remain with Telestream or others for whom Telestream has obtained a respective licensing right. Customer shall pay when due all property taxes that may now or hereafter be imposed, levied or assessed with respect to the possession or use of the Program or this license and shall file all reports required in connection with such taxes. If the Program or any related documentation is acquired by or for an agency of the U.S. Government, the Program and documentation shall be considered "commercial computer software" or "commercial computer software documentation" respectively, as those terms are used in 48 CFR §12.212, 48 CFR §227.7202, or 48 CFR §252.227-7014, and are licensed with only those rights as are granted to all other licensees as set forth in this Agreement.

THE PROGRAM MAY NOT BE USED, COPIED, MODIFIED, MERGED, OR TRANSFERRED TO ANOTHER EXCEPT AS EXPRESSLY PERMITTED BY THESE TERMS AND CONDITIONS. UPON TRANSFER OF ANY COPY, MODIFICATION, OR MERGED PORTION OF THE PROGRAM, THE LICENSE GRANTED HEREIN IS AUTOMATICALLY TERMINATED WITH RESPECT TO THE PARTY THAT TRANSFERS THE PROGRAM.

TERM

The license granted herein is effective upon acceptance by Customer, and shall remain in effect until terminated as provided herein. The license may be terminated by Customer at any time upon written notice to Telestream. The license may be terminated by Telestream or any third party from whom Telestream may have obtained a respective licensing right if Customer fails to comply with any term or condition and such failure is not remedied within thirty (30) days after notice hereof from Telestream or such third party. Upon termination by either party, Customer shall return to Telestream or destroy, the Program and all associated documentation, together with all copies in any form.

LIMITED WARRANTY

The Program is provided "as is" without warranty of any kind, either express or implied. Telestream does not warrant that the functions contained in the Program will meet Customer's requirements or that the operation of the Program will be uninterrupted or error-free.

TELESTREAM AND ITS VENDORS DISCLAIM ANY IMPLIED WARRANTIES OF MERCHANTABILITY OR FITNESS FOR A PARTICULAR PURPOSE. LIMITATION OF LIABILITY, IN NO EVENT SHALL TELESTREAM OR OTHERS FROM WHOM TELESTREAM HAS OBTAINED A LICENSING RIGHT BE LIABLE FOR ANY INDIRECT, SPECIAL, INCIDENTAL, OR CONSEQUENTIAL DAMAGES ARISING OUT OF OR CONNECTED WITH CUSTOMER'S POSSESSION OR USE OF THE PROGRAM, EVEN IF TELESTREAM OR SUCH OTHERS HAS ADVANCE NOTICE OF THE POSSIBILITY OF SUCH DAMAGES.

THIRD-PARTY DISCLAIMER

Except as expressly agreed otherwise, third parties from whom Telestream may have obtained a licensing right do not warrant the program, do not assume any liability with respect to its use, and do not undertake to furnish any support or information relating thereto.

GENERAL

This Agreement contains the entire agreement between the parties with respect to the use, reproduction, and transfer of the Program. Neither this Agreement nor the license granted herein is assignable or transferable by Customer without the prior written consent of Telestream. This Agreement and the license granted herein shall be governed by the laws of the state of California. All questions regarding this Agreement or the license granted herein should be directed to the nearest Telestream Sales Office.

Contents

Important compliance and safety information 11

Preface 20

Getting Started 23

- Product description 24
- Rackmount 30
- MPI Power-on and Power-off Procedures 32
- MPX Power-on and Power-off Procedures 35
- SFP Module Installation 37
- Network Installation 38
- MPI Rear Panel Connectors 40
- MPX Rear Panel Connectors 43
- Display Elements 46
- Activity Center 48

Methods of Operation 55

- MPI Touchscreen Operation 56
- MPX Front-panel Controls 60
- Keyboard and Mouse Operation 62
- External Touchscreen Display Operation 64
- Manage Tile Display 65
- Remote Control through VNC Operation 68
- Remote Control through API Commands 71

Configure the Instrument 77

- Configure and Select Signal Inputs 78
- Configure Instrument for HDR/WCG Monitoring 100
- Enable NMOS Discovery and Registration 102
- Adjust Loudness Display 103
- Configure Instrument Outputs 109

Configure to Decode Timecode	110
Configure Reference Settings	111
Set and Recall Instrument Presets	114
Manage Trace and Graticule Intensity	130
Set Time and Date	131
Upgrade Instrument Firmware	133
Upgrade Software License	136
Troubleshooting	137

Functions 139

Headphone/Speaker Volume, Balance, Device, and Source Adjustment Capture	142
--	-----

Application Information 145

Base Instrument Applications	146
Option MP2-IP-MEAS	147
Option MP2-GEN	148
Options MP2-ENG and MP2-QC	148
Option PHY	149
Option MP2-PROD	149
Options MP2-DLBY and MP2 AUD	150
Waveform Application	151
Vector Application	163
Audio Application	171
Picture Application	182
Video Session Application	191
Timing Application	196
Event Log Application	199
IP Status Application	207
IP Session Application	210
IP Graphs Application	226
PIT Histogram Application	232
PTP Graphs Application	235
Stream Timing Application	238
IP Generator Application	244
SDI Generator Application	251
Datalist Application	254
ANC (Ancillary Data) Session Application	256
Jitter Application	259
Eye Application	261
Stop Display Application	263
Diamond Application	271
Lightning Application	276
CIE Application	284
Dolby Status Application	288

PTP Operational Overview	293
PTP Introduction	294
Five Basic PTP Timing Messages	295
Profiles and Domains	297
One-step and Two-step Operation	298
Multicast, Unicast, and Mixed Communication Modes	299
BMCA Operation	301
Compensating for Causes of Asymmetric Delay	302

Important compliance and safety information

United States of America Compliance Notices

Class A Interference Statement

This equipment has been tested and found to comply with the limits for a Class A digital device, pursuant to Part 15, Subpart B of the FCC Rules. These limits are designed to provide reasonable protection against harmful interference in a commercial installation. This equipment generates, uses, and can radiate radio frequency energy and, if not installed and used in accordance with the instructions, may cause harmful interference to radio communications. However, there is no guarantee that interference will not occur in a particular installation. Operation of this equipment in a residential area is likely to cause harmful interference in which case the user will be required to correct the interference at his own expense.

FCC Caution

This device complies with Part 15 of the FCC Rules. Operation is subject to the following two conditions:

1. This device may not cause harmful interference, and
2. This device must accept any interference received, including interference that may cause undesired operation.

Safety

UL 61010-1: 2012 R4.16: Safety Requirements for Electrical Equipment for Measurement, Control, and Laboratory Use - Part 1: General Requirements.

Environmental

Perchlorate Materials: this product contains one or more type CR lithium batteries. According to the state of California, CR lithium batteries are classified as perchlorate materials and require special handling.

See www.dtsc.ca.gov/hazardouswaste/perchlorat for additional information.

Canada Compliance Notices

Department of Communications Radio Interference Regulations

This digital apparatus does not exceed the Class A limits for radio-noise emissions from a digital apparatus as set out in the Radio Interference Regulations of the Canadian Department of Communications. This Class A digital apparatus complies with Canadian ICES-003.

Reglement sur le brouillage radioelectrique du Quadstere des Communications

Cet appareil numerique respecte les limites de bruits radioelectriques visant les appareils numeriques de classe A prescrites dans le Reglement sur le brouillage radioelectrique du Quadstere des Communications du Canada. Cet appareil numerique de la Classe A est conforme a la norme NMB-003 du Canada.

Safety

CAN/CSA-22.2 NO. 61010-1-12 + Gil + G12:: Safety Requirements for Electrical Equipment for Measurement, Control, and Laboratory Use - Part 1: General Requirements.

Sécurité

CAN / CSA-22.2 NO. 61010-1-12 + Gil + G12 :: Exigences de sécurité pour l'électricité Matériel de mesure, de contrôle et d'utilisation en laboratoire - Partie 1: Généralités Exigences.

European Union and European Free Trade Association (EFTA) Compliance Notices

This equipment may be operated in the countries that comprise the member countries of the European Union and the European Free Trade Association. These countries, listed in the following paragraph, are referred to as The European Community throughout this document:

AUSTRIA, BELGIUM, BULGARIA, CYPRUS, CZECH REPUBLIC, DENMARK, ESTONIA, FINLAND, FRANCE, GERMANY, GREECE, HUNGARY, IRELAND, ITALY, LATVIA, LITHUANIA, LUXEMBOURG, MALTA, NETHERLANDS, POLAND, PORTUGAL, ROMANIA, SLOVAKIA, SLOVENIA, SPAIN, SWEDEN, UNITED KINGDOM, ICELAND, LICHTENSTEIN, NORWAY, SWITZERLAND

Declaration of Conformity

Marking by the "CE" symbol indicates compliance with the Essential Requirements of the EMC Directive of the European Union 2014/30/EU

This equipment meets the following conformance standards:

Safety

EN 61010-1: Safety Requirements for Electrical Equipment for Measurement, Control, and Laboratory Use - Part 1: General Requirements Low Voltage Directive 2014/35/EU

Emissions

EN 55032: 2012 + AC: 2013, CISPR 32: 2015, EN 61000-3-2: 2014, EN 61000-3-3: 2013

Immunity

EN 55103-2: 2009, EN 61000-4-2: 2009,

EN 61000-4-3: 2006 + A1: 2008 + A2: 2010, EN 61000-4-4: 2004 + A1: 2010,

EN 61000-4-5: 2006, EN 61000-4-6: 2009, EN 61000-4-11: 2004

Environments: E2

Warnings

Warning! This is a Class A product. In a domestic environment, this product may cause radio interference, in which case, the user may be required to take appropriate measures.



Achtung! Dieses ist ein Gerat der Funkstorgrenzwertklasse A. In Wohnbereichen können bei Betrieb dieses Gerates Rundfunkstörungen auftreten, in welchen Fallen der Benutzer für entsprechende Gegenmaßnahmen verantwortlich ist.



Attention! Ceci est un produit de Classe A. Dans un environnement domestique, ce produit risque de créer des interférences radioélectriques, il appartient alors à l'utilisateur de prendre les mesures spécifiques appropriées.

Notes:

1. For Compliance with the EMC standards listed here, high quality shielded interface cables should be used.
2. Emissions which exceed the levels required by this standard may occur when this equipment is connected to a test object.

Environmental Compliance

This section provides information about the environmental impact of the product.

Product end-of-life handling

Observe the following guidelines when recycling an instrument or component:

Equipment recycling

Production of this equipment required the extraction and use of natural resources. The equipment may contain substances that could be harmful to the environment or human health if improperly handled at the product's end of life. To avoid release of such substances into the environment and to reduce the use of natural resources, we encourage you to recycle this product in an appropriate system that will ensure that most of the materials are reused or recycled appropriately.

This symbol on the product or its packaging indicates that this product complies with the applicable European Union requirements according to Directives 2012/19/EU and 2006/66/EC on waste electrical and electronic - equipment (WEEE) and batteries.

It also indicates that this product must not be disposed of with your other household waste. Instead, it is your responsibility to dispose of your waste equipment by handing it over to a designated collection point for the recycling of waste electrical and electronic equipment. The separate collection and recycling of your waste equipment at the time of disposal will help conserve natural resources and ensure that it is recycled in a manner that protects human health and the environment. For more information about where you can drop off your waste for recycling, please contact your local authority, or where you purchased your product.

Battery Recycling

This product may contain a rechargeable battery, which must be recycled or disposed of properly. Please properly dispose of or recycle the battery according to local government regulations.

Transporting Batteries or products with Batteries in them

The capacity of the lithium ion secondary battery shipped with this product is under 100 Wh. The lithium content of the installed primary battery is under 1 g. Each battery meets the applicable requirements of UN Manual of Tests and Criteria Part III Section 38.3. Battery quantity is under the limit for shipment according to Section II of the relevant Packing Instructions from the IATA Dangerous Goods Regulations. Consult your air carrier for applicability and determination of any special lithium battery transportation requirements.

Restriction of Hazardous Substances

This product is classified as an industrial monitoring and control instrument, and is not required to comply with the substance restrictions of the RoHS 3 Directives 2011 /65/ EU and EU 2015/863 until July 22, 2021. This product does, however, comply with the RoHS 2 Directive 2011/65/EU.

Korea Compliance Statement

<p>A급 기기 (업무용 방송통신기자재)</p>	<p>이 기기는 업무용(A급) 전자파적합기기로서 판매자 또는 사용자는 이 점을 주의하시기 바라며, 가정외의 지역에서 사용하는 것을 목적으로 합니다.</p>
<p>Class A (Broadcasting Communication Equipment for Office Use)</p>	<p>As an electromagnetic wave equipment for office use (Class A), this equipment is intended to use in other than home area. Sellers or users need to take note of this.</p>

Taiwan Compliance Statement

警告使用者：
這是甲類的資訊產品，在居住的環境中使用時，可能會造成射頻干擾，在這種情況下，使用者會被要求採取某些適當的對策。

This is a Class A product based on the standard of the Bureau of Standards, Metrology and Inspection (BSMI) CNS 13438, Class A. In a domestic environment this product may cause radio interference in which case the user may be required to take adequate measures.

Japan Compliance Statement

この装置は、クラスA情報技術装置です。この装置を家庭環境で使用すると電波妨害を引き起こすことがあります。この場合には使用者が適切な対策を講ずるよう要求されることがあります。 VCCI-A

This is a Class A product based on the standard of the VCCI Council (VCCI 32: 2016). If this equipment is used in a domestic environment, radio interference may occur, in which case, the user may be required to take corrective actions.

Important Safety Information

This manual contains information and warnings that must be followed by the user for safe operation and to keep the product in a safe condition. To safely perform service on this product, see the Service safety summary that follows the General safety summary.

General Safety Summary

Use the product only as specified. Review the following safety precautions to avoid injury and prevent damage to this product or any products connected to it. Carefully read all instructions. Retain these instructions for future reference.

Comply with local and national safety codes.

For correct and safe operation of the product, it is essential that you follow generally accepted safety procedures in addition to the safety precautions specified in this manual.

The product is designed to be used by trained personnel only.

Only qualified personnel who are aware of the hazards involved should remove the cover for repair, maintenance, or adjustment. Before use, always check the product with a known source to be sure it is operating correctly.

While using this product, you may need to access other parts of a larger system. Read the safety sections of the other component manuals for warnings and cautions related to operating the system.

When incorporating this equipment into a system, the safety of that system is the responsibility of the assembler of the system.

To Avoid Fire or Personal Injury

Use proper power cord: Use only the power cord specified for this product and certified for the country of use. Do not use the provided power cord for other products.

Ground the product: This product is grounded through the grounding conductor of the power cord. To avoid electric shock, the grounding conductor must be connected to earth ground. Before making connections to the input or output terminals of the product, ensure that the product is properly grounded. Do not disable the power cord grounding connection.

Power disconnect: The power cord disconnects the product from the power source. See instructions for the location. Do not position the equipment so that it is difficult to operate the power cord; it must remain accessible to the user at all times to allow for quick disconnection if needed.

Observe all terminal ratings: To avoid fire or shock hazard, observe all rating and markings on the product. Consult the product manual for further ratings information before making connections to the product. Do not apply a potential to any terminal, including the common terminal, that exceeds the maximum rating of that terminal.

Do not operate without covers: Do not operate this product with covers or panels removed, or with the case open. Hazardous voltage exposure is possible.

Avoid exposed circuitry: Do not touch exposed connections and components when power is present.

Do not operate with suspected failures: If you suspect that there is damage to this product, have it inspected by qualified service personnel.

Disable the product if it is damaged. Do not use the product if it is damaged or operates incorrectly. If in doubt about safety of the product, turn it off and disconnect the power cord. Clearly mark the product to prevent its further operation.

Before use, inspect voltage probes, test leads, and accessories for mechanical damage and replace when damaged. Do not use probes or test leads if they are damaged, if there is exposed metal, or if a wear indicator shows.

Examine the exterior of the product before you use it. Look for cracks or missing pieces.

Use only specified replacement parts.

Do not operate in wet/damp conditions: Be aware that condensation may occur if a unit is moved from a cold to a warm environment.

Do not operate in an explosive atmosphere.

Keep product surfaces clean and dry: Remove the input signals before you clean the product.

Provide proper ventilation: Refer to the manual's installation instructions for details on installing the product so it has proper ventilation.

Slots and openings are provided for ventilation and should never be covered or otherwise obstructed. Do not push objects into any of the openings.

Provide a safe working environment: Always place the product in a location convenient for viewing the display and indicators.

Be sure your work area meets applicable ergonomic standards. Consult with an ergonomics professional to avoid stress injuries.

Use only the Telestream rackmount hardware specified for this product.

Service Safety Summary

The Service safety summary section contains additional information required to safely perform service on the product. Only qualified personnel should perform service procedures. Read this Service safety summary and the General safety summary before performing any service procedures.

To avoid electric shock: Do not touch exposed connections.

Do not service alone: Do not perform internal service or adjustments of this product unless another person capable of rendering first aid and resuscitation is present.

Disconnect power: To avoid electric shock, switch off the product power and disconnect the power cord from the mains power before removing any covers or panels, or opening the case for servicing.

Use care when servicing with power on: Dangerous voltages or currents may exist in this product. Disconnect power, remove battery (if applicable), and disconnect test leads before removing protective panels, soldering, or replacing components.

Verify safety after repair: Always recheck ground continuity and mains dielectric strength after performing a repair.

Terms in the Manual

These terms may appear in this manual:



WARNING: Warning statements identify conditions or practices that could result in injury or loss of life.



Caution: Caution statements identify conditions or practices that could result in damage to this product or other property.

Terms on the Product

These terms may appear on the product:

DANGER indicates an injury hazard immediately accessible as you read the marking.

WARNING indicates an injury hazard not immediately accessible as you read the marking.

CAUTION indicates a hazard to property including the product.

Symbols on the Product

When this symbol is marked on the product, be sure to consult the manual to find out the nature of the potential hazards and any actions which have to be taken to avoid them. (This symbol may also be used to refer the user to ratings in the manual.)

The following symbol(s) may appear on the product:



General Safety Product Specific Statements

Use the product only as specified. Review the following safety precautions to avoid injury and prevent damage to this product or any products connected to it.

Carefully read all instructions. Retain these instructions for future reference.

Comply with local and national safety codes.

For correct and safe operation of the product, it is essential that you follow generally accepted safety procedures in addition to the safety precautions specified in this manual. The product is designed to be used by trained personnel only.

Only qualified personnel who are aware of the hazards involved should remove the cover for repair, maintenance, or adjustment.

Before use, always check the product with a known source to be sure it is operating correctly.

This product is not intended for detection of hazardous voltages.

Use personal protective equipment to prevent shock and arc blast injury where hazardous live conductors are exposed.

When incorporating this equipment into a system, the safety of that system is the responsibility of the assembler of the system.



WARNING: To prevent injury or death, power off the instrument and disconnect it from line voltage before cleaning.



WARNING: To reduce the risk of fire and shock, ensure that the mains supply voltage fluctuations do not exceed 10% of the operating voltage range.



WARNING: In the instrument, only the line conductor is fused for over-current protection. The fuse is internal and not user replaceable. Do not attempt to replace the fuse. If you suspect the fuse has blown, return the unit to an authorized service center for repair.



Caution: To reduce risk of fire and shock, use the certified power cord provided with the product.



Caution: Damage to the instrument can occur if this instrument is powered on at temperatures outside the specified temperature range.



Caution: To minimize the risk of damage to the instrument, we strongly recommend that the power cord be connected to the instrument before the power cord is connected to the AC power source



Caution: To prevent data loss, we strongly recommend you first shut down the instrument before disconnecting the power cord. Press the power button or select *Settings, Utilities, Power*, and then *Power Down Now*.



Caution: To prevent static damage to the SFP module, if you remove the SFP module from the instrument, always transport the SFP module in an anti-static bag or container.
To prevent possible damage to the PRISM monitor and SFP modules, remove the SFP modules before transporting the PRISM monitor.



Caution: After the instrument has started the upgrade process, DO NOT remove power from the instrument. If you do so, the instrument flash will be corrupted. The instrument will have to be sent to a Telestream factory service center to have the system firmware restored.

Preface

This manual contains information to help you use the PRISM SDI / IP Waveform Monitor:

- How to operate the instrument using the front panel, external mouse/keyboard/display, or remote connection.
- "How to use the various displays for monitoring SDI or IP video signals.
- "How to capture display data.
- "How to set up error logging and alarms.
- "How to use instrument menus.

Where to find more information

The full User Manual, Release Notes, and other information about your product are available for download at www.telestream.net/video/resources.htm. Table 1 lists all the documentation for the PRISM SDI / IP Waveform Monitor.

Product documentation

Document	Manual type	Part number	Description
User Manual	User	D00010020x	Provides detailed operating information.
Release Notes	Release Notes	D00010030x	Describes the new features, improvements, and limitations of the instrument firmware.
Installation and Safety Instructions	User	071-3628-00x	Describes how to install a PRISM MPI instrument and provides basic safety and operating information (included with instrument).
	User	071-3629-00x	Describes how to install a PRISM MPX instrument and provides basic safety and operating information (included with instrument).
Specifications and Performance Verification	Performance Verification	077-1523-00x	Lists the product specifications and provides procedures for verifying product performance.

Product documentation

PRISM MPI Dual Rack Cabinet Version 2 Installation Instructions	Field Install Instructions	071-3725-00x	Describes how to install an MPI instrument in a 19" equipment rack using the optional MPI-RACK-MM or MPI-RACK-MW dual rack cabinet.
MPX Rackmount Slides and Rails Installation Instructions	Field Install Instructions	071-3706-00x	Describes how to install an MPX instrument in a 19" equipment rack
PRISM MPI2-RACK-MD Installation and Safety Instructions	Field Install Instructions	071-3728-00x	Provides installation and safety information for the PRISM MPI2-RACK-MD Rack Cabinet with touch display.
PRISM MPX2-DUALDSP Installation and Safety Instructions	Field Install Instructions	071-3729-00x	Provides installation and safety information for the PRISM MPX2-DUALDSP Dual Display module.
Field Upgrade Kit Instructions	Field Install Instructions	075-1136-00x	Describes how to install post-purchase field upgrades in the instrument.

Conventions used in this manual

The PRISM SDI / IP Waveform Monitor is also referred to as the "PRISM monitor" throughout this manual.

Telestream Contact Information

To obtain product information, technical support, or provide comments on this guide, contact us using our web site, email, or phone number as listed below.

Resource	Contact Information
Telestream Video Support	Web Site: http://www.telestream.net/telestream-support Email: videosupport@telestream.net US and Canada Toll-free: 1-844-219-5329 Outside of US and Canada: 1-503-967-9833
Telestream	Web Site: www.telestream.net Sales and Marketing Email: info@telestream.net Telestream 848 Gold Flat Road, Suite 1 Nevada City, CA. USA 95959

Resource	Contact Information
International Distributor Support	Web Site: www.telestream.net See the Telestream Web site for your regional authorized Telestream distributor.
Telestream Technical Writers	Email: techwriter@telestream.net If you have comments or suggestions about improving this document, or other Telestream documents—or if you've discovered an error or omission, please email us.

Getting Started

This section helps you set up and begin to use the PRISM SDI / IP Waveform Monitor. It is divided into subsections:

Product description describes your instrument and provides a list of key features.

Controls and connectors shows you how to verify that you have received all of the parts of your instrument and provides a list of standard and optional accessories and a list of options that are available for your instrument.

Network installation shows you how to set up your instrument on an Ethernet network.

Product description

The PRISM SDI / IP Waveform Monitor provides flexible options and field-installable upgrades to monitor a diverse variety of SDI and IP statistics as well as video and audio content. The comprehensive feature set, along with an intuitive and simplified graphical presentation of IP statistics, including video quality and diagnostic information, enables engineers to ensure the delivery of superior QoS levels in an increasingly complex broadcast environment involving compressed / uncompressed video transmission through SDI/IP signal paths. PRISM is an ideal solution for monitoring SDI/IP hybrid environments including master control rooms, production studios, OB vans, and signal contribution/distribution centers.

PRISM Model Form Factors

The PRISM SDI / IP Waveform Monitor is available in two form factors:

MPI

The PRISM MPI is 3RU half-rack width with integrated 9-inch HD display and touch panel. Option PHY is available to add physical layer measurement sets.



MPX

The PRISM MPX is 1RU full-rack width with optional integrated speakers. The MPX requires an external monitor or a remote connection, such as VNC (a remote connection requires a local monitor or a DisplayPort emulator that is connected to the PRISM). Option PHY is available to add physical layer measurement sets. Option RACK is required for rack mount.



Features and Benefits for Analysis of Hybrid IP/SDI Infrastructures

- A comprehensive analysis and monitoring tool for hybrid IP/SDI broadcast systems that provide system evaluation for long term system quality monitoring and reporting
- All-in-one instrument using a 3RU half-rack platform (MPI) or a 1RU full-rack platform (MPX) with optional integrated speakers can be used for either portable or rackmount applications
- Extensive IP monitoring solution for SMPTE 2022-6, 2110, PTP, and RTP streams
- Graphical displays that show the traffic present in the 10GE Ethernet link, allowing engineers to understand what is on their network and to easily select the stream of interest
- Select a stream to view and monitor the content using the Picture, Waveform, and Audio applications, and listen to audio with headphones for conformance monitoring
- Detect IP packet errors, monitor the packet inter arrival time (PIT) and time stamped delay factor (TS-DF for 2022-6) to allow engineers to observe issues that may cause intermittent loss of video, audio, or data
- Monitor PTP trend graphs to ensure proper IP system setup for robust sync system
- Telestream patented Timing display, the SDI versus Analog reference and ST2022-6 / ST2110-20 / SDI / Analog reference versus PTP reference makes facility timing easy
- 1 PPS output when the instrument is locked to a PTP reference
- Seamless switching to ensure proper SMPTE 2022-6 and 2110 redundancy according to SMPTE 2022-7
- API to control PRISM from system management software
- Multipoint or remote site monitoring allowing one engineer to quickly respond to issues from multiple points in the system
- Optional 10GE line-rate packet capture for offline analysis
- Optional SDI and ST2110 IP signal generators for testing new or changing facility configurations
- The Picture application uses the 9-inch HD screen for confidence monitoring
- NMOS IS-04 / IS-05 support for network discovery and connection management (receiver only)
- Optional dual display products (MPI2-RACK-MD and MPX2-DUALDSP) can be used to extend the workspace to a second HD screen.

Features and Benefits for Production Tools Supporting 4K/ UHD, WCG, and HDR Content Creation

- A comprehensive production tool set supporting 4K / WCG / HDR content creation

- SDI/IP hybrid interface supporting up to 4K resolution, up to 2160p60 format support with 12G-SDI / Quad 3G-SDI interface, and up to 1080p60 format with SMPTE 2022-6/7 and 2110
- Stop display for monitoring video signals with a variety of transfer functions in a consistent manner
- Configurable False Color display for easy identification of HDR content.
- Waveform, Vector, Lightning, Picture, and Diamond Displays, which are equipped with a transfer function/color space conversion allowing operators to match skin tones of video signals to standard BT.709 vector locations and verify wide color gamut compatibility to BT.709 color gamut
- 12G-SDI physical layer measurements to check SDI signal quality and integrity (optional)
- On-screen tools for accessing frequently used settings without opening a separate menu
- Audio volume and balance controls

Supported Formats

Supported SDI formats

Link	Format	Sample Structure	Bits	Frame/field rate	Option	
SD-SDI	525i	4:2:2	YCbCr	10b	59.94i	Base instrument
	625i	4:2:2	YCbCr	10b	50i	Base instrument
HD-SDI	1920x1080	4:2:2	YCbCr	10b	50/59.94/60i, 23.98/24/25/ 29.97/30p, and psF	Base instrument
	1280x720	4:2:2	YCbCr	10b	23.98/24/25/ 29.97/30/50/ 59.94/60p	Base instrument
3G-SDI Level A	1920x1080	4:2:2	YCbCr	10b	50/59.94/60p	Base instrument
3G-SDI Level B	1920x1080	4:2:2	YCbCr	10b	50/59.94/60p	Base instrument
Quad Link HD-SDI Square Division	3840x2160	4:2:2	YCbCr	10b	23.98/24/25/ 29.97/30p, and psF	MP2-FMT-4K
Quad Link 3G-SDI Level A, Square Division	3840x2160	4:2:2	YCbCr	10b	50/59.94/60p	MP2-FMT-4K

Supported SDI formats

Quad Link 3G-SDI Level B, Square Division	3840x2160	4:2:2	YCbCr	10b	50/59.94/60p	MP2-FMT-4K
Quad Link 3G-SDI Level A, Two Sample Interleave	3840x2160	4:2:2	YCbCr	10b	50/59.94/60p	MP2-FMT-4K
Quad Link 3G-SDI Level B, Two Sample Interleave	3840x2160	4:2:2	YCbCr	10b	50/59.94/60p	MP2-FMT-4K
6G-SDI	3840x2160	4:2:2	YCbCr	10b	23.98/24/25/ 29.97/30p	MP2-FMT-4K
12G-SDI	3840x2160	4:2:2	YCbCr	10b	50/59.94/60p	MP2-FMT-4K
Quad Link 12G-SDI	7680x4320	4:2:2	YCbCr	10b	50/59.94/60p	MP2-FMT-8K

Supported video formats in SMPTE 2110-20 streams

Link	Format	Sample Structure		Bits	Frame/field rate	Option
ST2110-20	525i	4:2:2	YCbCr	10b	59.94i	Base instrument
	625i	4:2:2	YCbCr	10b	50i	Base instrument
	1920x1080	4:2:2	YCbCr	10b	50/59.94/60i	Base instrument
	1280x720	4:2:2	YCbCr	10b	50/59.94/60p	Base instrument
	1920x1080	4:2:2	YCbCr	10b	50/59.94/60p	Base instrument
	3840x2160	4:2:2	YCbCr	10b	50p	MP2-FMT-4K
	3840x2160	4:2:2	YCbCr	10b	59.94/60p	MP2-FMT-4K

Supported video formats in SMPTE 2022-6 streams

Link	Format	Sample Structure		Bits	Frame/field rate	Option
SD-SDI	525i	4:2:2	YCbCr	10b	59.94i	Base instrument
	625i	4:2:2	YCbCr	10b	50i	Base instrument
HD-SDI	1920x1080	4:2:2	YCbCr	10b	50/59.94/60i, 23.98/24/25/29.97/30p, and psF	Base instrument
	1280x720	4:2:2	YCbCr	10b	23.98/24/25/29.97/30/50/59.94/60p	Base instrument
3G-SDI Level A	1920x1080	4:2:2	YCbCr	10b	50/59.94/60p	Base instrument
3G-SDI Level B	1920x1080	4:2:2	YCbCr	10b	50/59.94/60p	Base instrument

SMPTE 2110-30 stream

Conformance level	Description
Conformance level B ¹	Reception of 48 kHz streams with 1 to 8 channels at packet times of 1 ms or 1 to 8 channels at packet times of 125 μs

1. Also supports reception of 48 kHz with 1 to 16 channels at packet times of 125 μ s.

Software Licenses

- MP2-IP-MEAS adds a node-locked license for IP Measurement feature sets, this includes IP/PTP Graph, IP/PTP Session, PIT Histogram, Timing, Stream Timing, and Stream capture applications.
- MP2-FMT-4K adds a node-locked license for 4K formats and enables 6G/12G-SDI.
- MP2-AUD adds a node-locked license for enhanced audio feature sets, this includes Phase, Session, Correlation, Loudness, and Dolby E status display.
- MP2-DLBY adds a node-locked license for Dolby E decoding and Dolby E status display.
- MP2-ENG adds a node-locked license for baseband engineering feature sets, this includes Datalist, CC decode, and ANC Session.
- MP2-QC adds a node-locked license for quality control feature sets, this includes Datalist, CC decode, and ANC Session.
- MP2-PROD adds a node-locked license for production feature sets, this includes Stop, False Color, Light meter, HDR/WCG Conversion, CIE, and HDR Measurements.
- MP2-GEN adds a node-locked license for SDI/IP signal generator, this includes IP/SDI Generator application.
- MP2-EXTNDSP adds a node-locked license for enabling extended desktop.

Rackmount

MPI Monitor

There are two optional dual rack cabinets (19-inch, 3RU) available for the PRISM monitor. Each of the cabinet kits include the *PRISM MPI Dual Rack Cabinet and Extender Installation Instructions document* (part number 071-3725-xx).

MPI-RACK-MM

Allows you to install one MPI unit or two MPI units side-by-side. Each side of the cabinet front panel has two USB ports and a headphone port for each MPI unit.

MPI-RACK-MW

Allows you to install one MPI unit or one MPI unit in a side-by-side installation with a WFM52x0, WFM7200, WFM8x00 waveform monitor. The left side of the cabinet front panel has two USB ports and a headphone port for one MPI unit.

Dual Rack Cabinet Versions

There are two versions of the instructions for the MPI-RACK-MM and MPI-RACK-MW dual rack cabinets:

PRISM dual rack cabinet documentation

Document	Part Number	Description
PRISM MPI Dual Rack Cabinet Version 1 Installation Instructions	071-3501-xx (English)	In version 1 of the instructions, the MPI-RACK-MM and the MPI-RACK-MW cabinets are the same size.
PRISM MPI Dual Rack Cabinet Version 2 Installation Instructions	071-3725-00x (English)	In the second version of the instructions, the MPI-RACK-MW cabinet comes with a removable extender installed that makes it longer than the MPI-RACK-MM cabinet.

MPX Monitor

For the PRISM MPX monitor, there is an optional 1RU full-rack kit that can be used for either portable or rackmount applications.

MPX RACK

Allows you to install one PRISM 1RU full width MPX RACK. The *MPX RACK rackmount kit includes the Rackmount Slides and Rails Kit Installation Instructions* document (part number 071-3706-xx).

Dual Display Monitors

Rack mounted dual display monitors are available for MPI2 and MPX2 to extend the PRISM display to a second HD monitor.

MPI2-RACK-MD

Allows you to install one PRISM MPI2 monitor (not included) next to an external HD display in a 3RU full width rack. A software license is required to enable the extended display feature. For information on how to install and use this extended display, see the *PRISM MPI2-RACK-MD Installation and Safety Instructions*.

MPX2-DUALDSP

Allows you to connect an MPX2 to a 3RU full rack width dual display assembly to serve as a compact primary and extended desktop display system for the MPX2. A software license is required to enable the extended display feature. For information on how to install and use this extended display, see the *PRISM MPX2-DUALDSP Installation and Safety Instructions*.

MPI Power-on and Power-off Procedures

This section describes how to apply power to the MPI monitor and how to power-on and power-off the instrument.

MPI Power Cord Installation

This instrument is powered by an AC power source. Connect the power cord to the power connector on the rear panel of the instrument.

The power connector is keyed to be directional, with the flat portion of the power cord housing facing the left of the instrument (as viewed from the rear). When fully inserted, the power cord housing latches onto the instrument power connector.

 **Caution: To minimize the risk of damage to the instrument, we strongly recommend the power cord be connected to the instrument before the power cord is connected to the AC power source.**

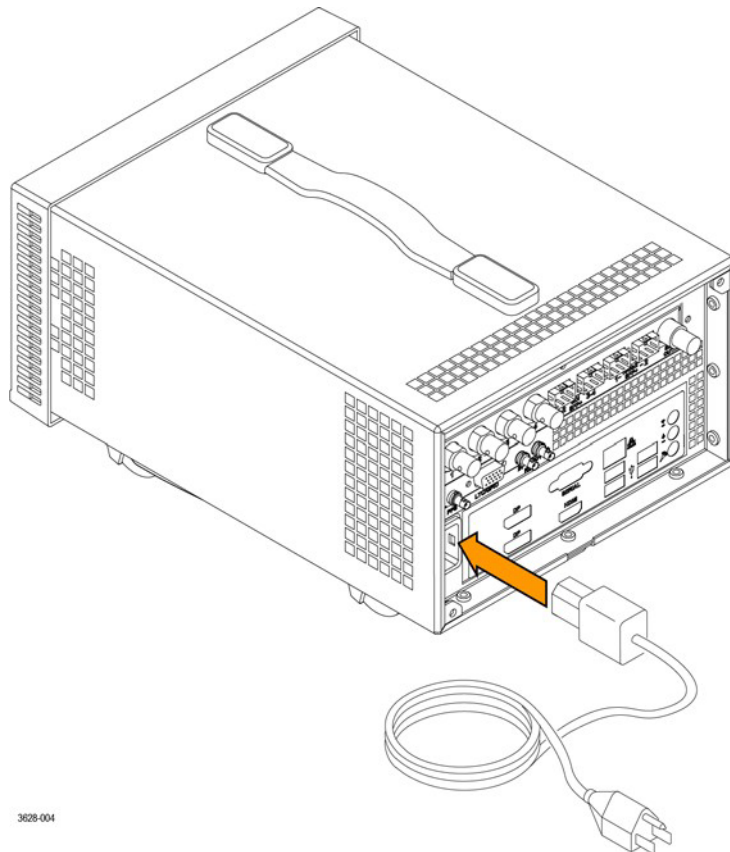

3828-004

MPI Power Cord Removal

The power cord housing latches on the instrument power connector when fully inserted. To remove the power cord, grasp the connector housing, as shown, and firmly pull the cord away from the instrument.

 **Caution: To prevent damage to the power cord or to the instrument power connector, do not attempt to disconnect the power cord by pulling on the cable. You must pull on the connector housing to disengage the locking mechanism.**

To minimize the risk of damage to the instrument, it is strongly recommended that the power cord be disconnected from the AC power source before the power cord is disconnected from the instrument.

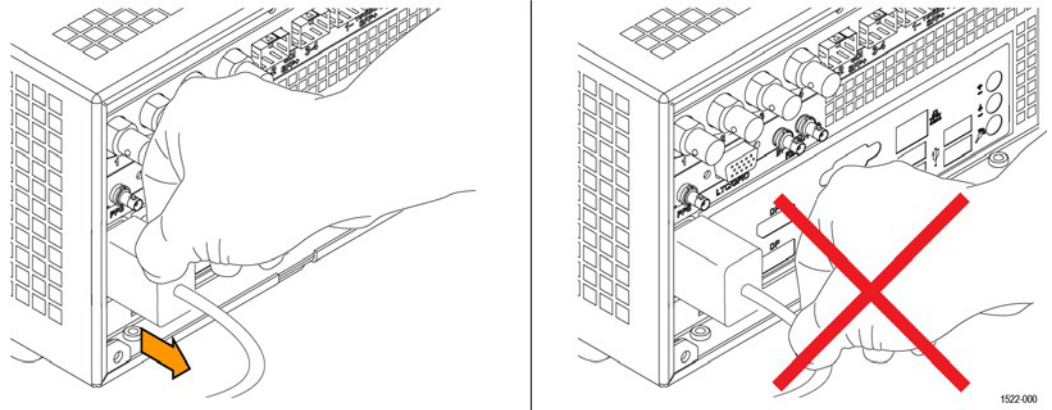

MPI Power-on Procedure

1. Apply power to the instrument. (See [MPI Power Cord Installation](#).)

Note: If the PRISM monitor was previously powered off by a power interruption or by removing the power cord from the rear of the instrument, the instrument powers on when power is reapplied.

2. Press the Power/Standby button on the instrument front panel to turn the instrument on.

Note: The MPI Power/Standby button turns red during the power-on sequence and turns white and then turns off in normal operation.



MPI Power-off Procedure

1. Press the Power/Standby button on the instrument front panel to turn the instrument off.
Or in the instrument:
 - a. Select **Settings**.
 - b. Select **Utilities**.
 - c. Select **Power**.
 - d. Select **Power Down Now**.

 **Caution:** To prevent data loss, we strongly recommend you first shut down the instrument before disconnecting the power cord.

2. To completely remove power from the instrument, disconnect the power cord from the instrument. The power cord has a locking mechanism to keep it attached to the instrument. Push the button on the cord housing to release the locking mechanism. (See [MPI Power Cord Removal](#).)

MPX Power-on and Power-off Procedures

This section describes how to apply power to the MPX monitor and how to power-on and power-off the instrument.

MPX Power Cord Installation

This instrument is powered by an AC power source. Connect the power cord to the power connector on the rear panel of the instrument.

The power connector is keyed to be directional, with the flat portion of the power cord housing facing the left of the instrument (as viewed from the rear). When fully inserted, the power cord housing latches onto the instrument power connector.

 **Caution: To minimize the risk of damage to the instrument, it is strongly recommended that the power cord be connected to the instrument before the power cord is connected to the AC power source.**

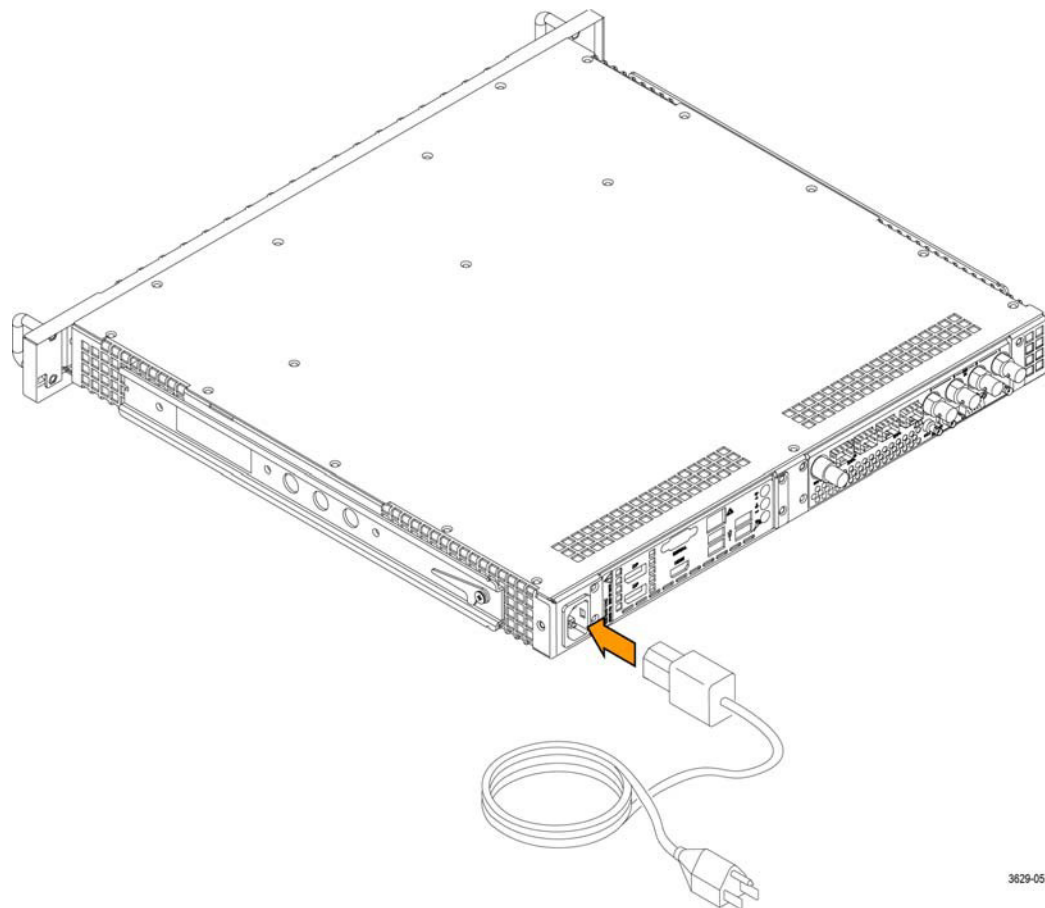

3629-05

MPX Power-on Procedure

1. Apply power to the instrument. (See [MPX Power Cord Installation](#).)

Note: If the PRISM monitor was previously powered off by a power interruption or by removing the power cord from the rear of the instrument, the instrument powers on when power is reapplied.

2. Press the Power/Standby button on the instrument front panel to turn the instrument on.



Note: The MPX Power/Standby button turns red during the power-on sequence and turns green and remains green in normal operation.

MPX Power-off Procedure

1. Press the Power/Standby button on the instrument front panel to turn the instrument off.

Or in the instrument:

- a. Select **Settings**.
- b. Select **Utilities**.
- c. Select **Power**.
- d. Select **Power Down Now**.



Caution: To prevent data loss, we strongly recommend you first shut down the instrument before disconnecting the power cord.

2. To completely remove power from the instrument, disconnect the power cord from the instrument. The power cord has a locking mechanism to keep it attached to the instrument. Push the button on the cord housing to release the locking mechanism.

SFP Module Installation

There are several types of optional SFP modules available:

- "SD/HD/3G-SDI optical transmitter
- "SD/HD/3G-SDI DIN transmitter
- "SD/HD/3G-SDI HD-BNC transmitter
- "10G Ethernet short range transceiver (850 nm)
- "10G Ethernet long range transceiver (1310 nm)

Note: ST2022-7 requires two 10GE SFP modules to be installed. The modules must be installed in SFP ports 1 and 2.

MPX and MPI SFP Module Installation

To install an SFP module on an MPX or MPI monitor, insert the SFP module into the SFP connector. The module latches into place when fully inserted.

Note: There are different types of SFP modules for 10GE signals. If the SFP module does not match the unit signal setting (for example, a 25GE SFP module is installed), the Link Status (in Network, under Settings) returns "SFP Error."

To remove the SFP module, pull the latch down or up as according to the SFP and then pull the module out of the SFP connector.

Note: To ensure you are using the correct SFP connectors, the 10GE and SDI SFP connectors are marked on the back of the MPI (see [MPI Rear Panel Connectors](#)) and MPX (see [MPX Rear Panel Connectors](#)). Different types of SFP modules may have different latching mechanisms.

SFP Module Transportation



Caution: To prevent static damage to the SFP module, if you remove the SFP module from the instrument, always transport the SFP module in an anti-static bag or container.



Caution: To prevent possible damage to the PRISM monitor and SFP modules, remove the SFP modules before transporting the PRISM monitor.

Network Installation

See the installation and safety instructions manual that shipped with your instrument for basic installation instructions.

After your instrument is physically installed, you might want to connect it directly to a PC or to a network. This section explains how.

Connect Directly to a PC

1. Connect the instrument directly to a PC with an Ethernet cable. You can also use an Ethernet Switch.
2. Set up the instrument as described in this procedure. Choose **Manual IP** mode to set the IP address manually. Be sure to set an address that is compatible with the setting of your PC.

Note: The default IP address of the PRISM monitor is 192.168.1.2.

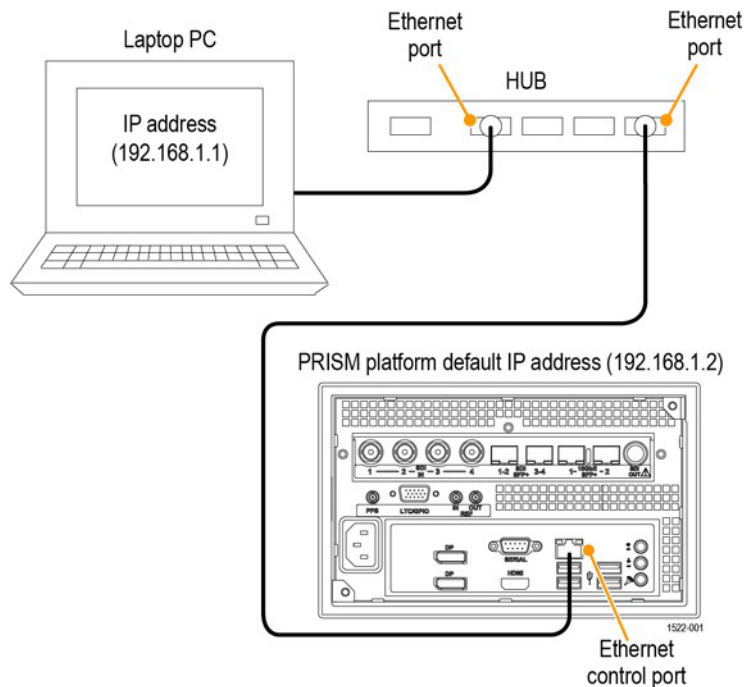

Connect to a network

To allow network access to the instrument, you must set the IP address. Network addresses can be assigned either automatically (DHCP) or manually. If your network does not use DHCP, you must manually enter the address for the instrument. To get a fixed address, talk to your LAN administrator. The default IP address of the PRISM monitor is 192.168.1.2.



To connect your instrument to a network and access it with a remote PC:

1. On the PRISM monitor, select the Settings icon () to display the Settings menu.
2. Select Network to open the Network submenu.
3. Select CONTROL IP PORT to open the Control IP Port submenu.
4. Depending on your local network requirements, select DHCP or Manual to select the method for selecting an IP address.



5. If you cannot use DHCP and you selected Manual, use the Manual submenu to set the IP address, subnet mask, gateway address, DNS address, and DNS Search Domain parameters you obtained from your LAN administrator. (Be sure to use compatible addresses between the PC and the instrument.)
6. Select an address box to open the address editing tool. Use the editing box as described for editing an IP input address.

 **Caution: Do not configure your control or your Video IP ports to addresses on the same subnet. This may cause a non-deterministic operation, such as IGMP leaves failing or other network connectivity issues.**

7. Select the Settings icon () or select the Close icon () to close the Settings menu.

MPI Rear Panel Connectors



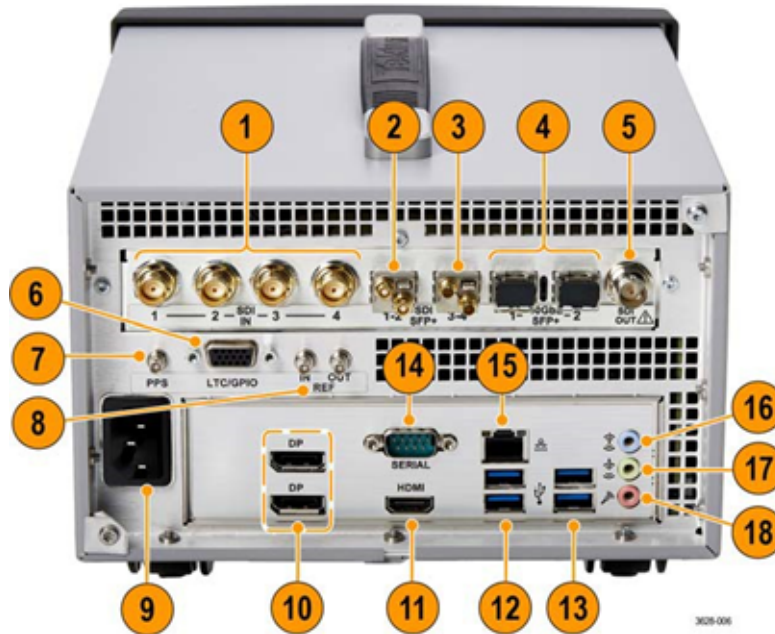

The illustration shows the external connections on the rear panel of the MPI instrument. A description of each connector is provided.





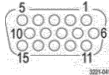

Descriptions of numbered PRISM MPI rear-panel connectors

Item number	Connector label, symbol, or end	Description
1	SDI IN	<p>Four BNC inputs can operate in these modes:</p> <ul style="list-style-type: none"> "SDI inputs 1 and 3 support SD/HD/3G/12G signals. SDI inputs 2 and 4 support SD/HD/3G signals. "Single SDI link (Option MP2-FMT-4K is required for 12G support). When used as a single link, only one of the SDI 1-4 inputs is active at a time. "Eye diagram up to 12G on SDI input 1 only for physical layer measurements, including automated measurement of 12G-SDI eye pattern parameters (requires Options MP2-FMT-4K and MPI PHY). "Quad 4K links when used in conjunction with the SDI 1-4 inputs (Option MP2-FMT-4K only). When used as Quad 4K links, all four SDI inputs are active.
2	SDI SFP+	<p>Two optional SFP outputs are for SDI signals (HD-BNC transmitter SFP+ modules shown). SDI SFP outputs 1 and 2 supports HD/3G signals.</p>

Descriptions of numbered PRISM MPI rear-panel connectors

Item number	Connector label, symbol, or end	Description
3	SDI SFP+	Two optional SFP outputs are for SDI signals (HD-BNC transmitter SFP modules shown). SDI SFP outputs 3 and 4 supports HD/3G signals.
4	10GbE SFP+	Two optional SFP ports are for 10GbE Ethernet applications.
5	SDI OUT	SDI output of the selected SDI or IP input.
6	LTC/GPIO 	15-pin, D-type connector for future functionality.
7	PPS	PPS connector outputs a 1 PPS (pulse per second) signal when the instrument is locked to a PTP reference. 3.3v drive. TTL compatible.
8	REF IN – OUT	REF IN is used for analog reference signals black burst and tri-level sync for locking. REF OUT is a pass through of the REF IN.
9		Connector for an AC power source.
10	DP	Two Display Port outputs are for external monitors. The output video format is 1920×1080. ¹ Note: An MPI can use a maximum of 1 external display, DP or HDMI.
11	HDMI	HDMI port output is for an external monitor. The output video format is 1920×1080. ¹ Note: An MPI can use a maximum of 1 external display, DP or HDMI.
13		Two USB 3.0 ports are for connecting a mouse and keyboard, importing or exporting instrument presets, upgrading the instrument firmware, or saving screen and stream captures.
14		Two USB 3.0 ports are for connecting a mouse and keyboard, importing or exporting instrument presets, upgrading the instrument firmware, or saving screen and stream captures.
15	SERIAL 	Serial interface, 9-pin connector, is not used.

Descriptions of numbered PRISM MPI rear-panel connectors

Item number	Connector label, symbol, or end	Description
16		Ethernet port is a standard RJ-45 connector for 10/100/1000Base-T Ethernet cable.
17		Audio input port is for future use.
18		Audio output (1/8-inch—3.5mm—line out) port is for headphones to listen to the selected audio channel pair. ²
19		Microphone input port is for future use.



1. When connecting to an external monitor, a monitor with a 1920×1080 capable display works best with the instrument.
2. Audio output is an 1/8-inch (3.5mm) diameter port for a headset. It has connections for L and R audio channels. Headset plugs that are an 1/8-inch and have an additional contact for a microphone may not work because the headphone ports are not set for the spacing requirements of a third connection on the plug.

MPX Rear Panel Connectors

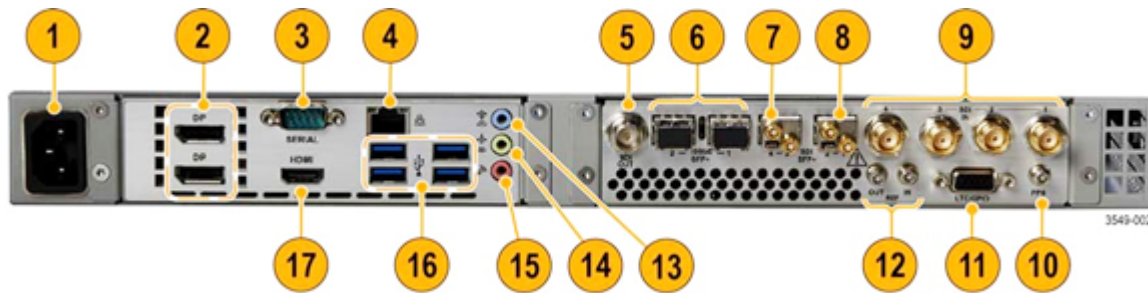

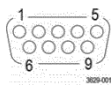

The next illustration shows the external connections on the rear panel of the MPX2–25 instrument. A description of each connector is provided. See [MPX Front-panel Controls](#) for information about the front panel connectors.

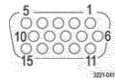

Descriptions of numbered PRISM MPX rear-panel connectors

Item number	Connector label, symbol, or end	Description
1		Connector for an AC power source.
2	DP	Two DisplayPort outputs are for external monitors. The output video format is 1920x1080. ¹ Note: An MPX can use a maximum of 2 external displays, DP or HDMI.
3	SERIAL 	Serial interface, 9-pin connector, is not used.
4		Ethernet port is a standard RJ-45 connector for 10/100/1000Base-T Ethernet cable.
5	SDI OUT 2	SDI output of the selected SDI, ST2022, or ST2110 input: Quadlink inputs (4k/8k) the Aux out is link 1 ST2110-20/30 inputs are supported.
6	10GbE SFP+ 2-1	Two optional SFP ports for 10 GbE Ethernet applications.
7	SDI SFP+ 4-3	Two optional SFP outputs for SDI signals. SDI SFP inputs 3 and 4 support HD/3G signals.

Descriptions of numbered PRISM MPX rear-panel connectors

Item number	Connector label, symbol, or end	Description
8	SDI SFP+ 2-1	Two optional SFP outputs for SDI signals. SDI SFP inputs 1 and 2 support HD/3G signals.
9	SDI I/O	Four BNC inputs can operate in these modes: <ul style="list-style-type: none"> • SDI inputs 1 and 3 support SD/HD/3G/12G signals. SDI inputs 2 and 4 support SD/HD/3G signals. • Single SDI link (Option MP2-FMT-4K is required for 12G support). When used as a single link, only one of the SDI 1-4 inputs is active at a time. • Eye diagram up to 12G on SDI input 1 only for physical layer measurements, including automated measurement of 12G-SDI eye pattern parameters (requires Options MP2-FMT-4K and MPX2 PHY). • Quad 4K links when used in conjunction with the SDI 1-4 inputs (Option MP2-FMT-4K only). When used as Quad 4K links, all four SDI inputs are active.
10	PPS	PPS connector outputs a 1 PPS (pulse per second) signal when the instrument is locked to a PTP reference. 3.3v drive. TTL compatible.
11	LTC/GPIO 	15-pin, D-type connector for future functionality.
12	REF IN – OUT	REF IN is used for analog reference signals black burst and tri-level sync for locking. REF OUT is a pass through of the REF IN.
13		Audio input port is for future use.
14		Audio output (1/8-inch—3.5mm—line out) port is for headphones to listen to the selected audio channel pair. ²
15		Microphone input port is for future use.

Descriptions of numbered PRISM MPX rear-panel connectors

Item number	Connector label, symbol, or end	Description
16		Four USB 3.0 ports are for connecting a mouse and keyboard, importing or exporting instrument presets, upgrading the instrument firmware, or saving screen and stream captures.
17	HDMI	HDMI port output is for an external monitor. The output video format is 1920×1080. ¹

Note: An MPX can use a maximum of 2 external displays, DP or HDMI.

1. When connecting to an external monitor, a monitor with a 1920×1080 capable display works best with the instrument.
2. 2 Audio output is an 1/8-inch (3.5mm) diameter port for a headset. It has connections for L and R audio channels. Headset plugs that are an 1/8-inch and have an additional contact for a microphone may not work because the headphone ports are not set for the spacing requirements of a third connection on the plug.

Display Elements

The illustration shows the key elements of the MPI internal monitor. Descriptions of the elements are provided in the Descriptions of PRISM Display Elements table.



Descriptions of numbered PRISM MPI Display Elements

Item number	Description
1-4	Application tile 1-4 ¹
5	<p>Status bar: The left side of the Status bar has icons with links to various instrument settings including Volume (🔊), Presets (⚙️), Settings (⚙️), Input type (🎧), and the Application menu (☰). Select the Home icon (🏠) to exit any displayed menus.</p> <p>The right side of the status bar lists instrument status such as the selected input, type of input signal, selected signal reference, video/reference signal status, audio channel status, the real time clock setting, and a link to the Activity menu (🚨).</p>

Descriptions of numbered PRISM MPI Display Elements

- 6 Power / Standby button: Press the button to turn the instrument on or off. To completely remove power from the instrument, remove the power cord.
-



Caution: To prevent data loss, we strongly recommend you first shut down the instrument before disconnecting the power cord. Press Power/Standby or select Settings, Utilities, Power, and then Power Down Now.

- 7 Application tabs: Some applications have selectable tabs (highlighted readouts) you can use to display additional information.
-

- 8 Application name: Lists the name of the displayed application.
-

¹ The applications can be in quarter-screen display, half-screen display, or one application in full-screen display.

Activity Center

The Activity center tracks messages and devices in the PRISM. For example, you can view messages that allow you to eject devices mounted to the instrument. These steps explain how to eject a USB drive from the instrument using the Activity center.

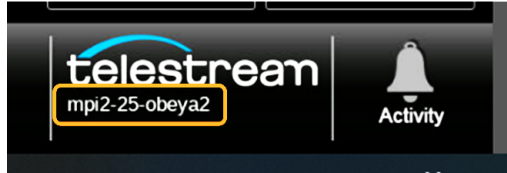

A number above the Activity icon indicates the number of messages waiting in and devices connected to the instrument.



1. Select the Activity icon to view the DASHBOARD messages, which includes devices connected to the instrument.

Note: After inserting a USB drive, it must be unmounted through the Activity icon before removing it from the instrument.

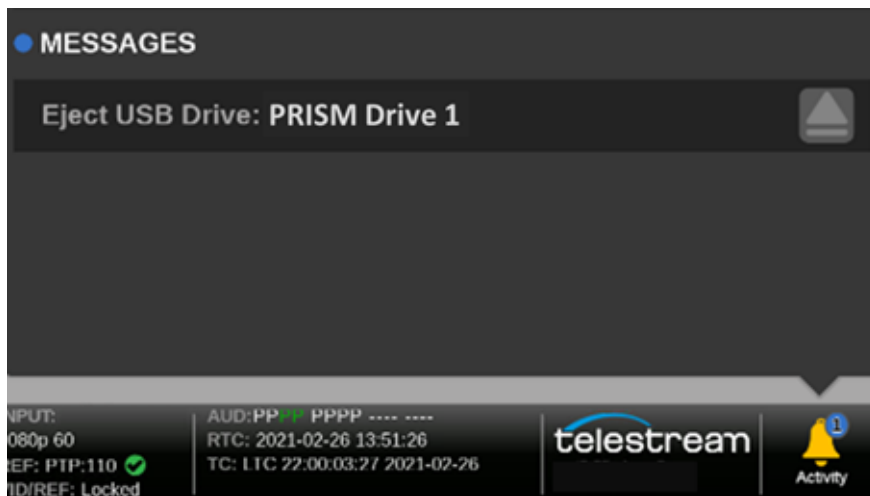

2. Select the Eject icon (🗑️) to unmount the USB drive from the instrument.

Note: If there is no USB drive in the instrument, the Eject USB Drive text and eject icon do not appear.

3. Select the Activity icon (🔔) again to close the window.

Monitor Alarms

The Activity DASHBOARD, in the status bar, provides a user-configurable alarm notification system. This allows the user to be only notified of the alarms of interest.

To configure which alarms you receive notifications for, see Alarm in the Settings menu.

The Activity icon is color coded:

- A gray icon means no alarms have been activated.



- A yellow icon means at least one alarm is active, but it is not longer present.



- A red icon means at least one alarm is currently active.

Note: Active alarms take precedence over cleared alarms. If there are cleared alarms and active alarms, the icon is red.

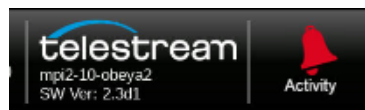

Use Activity DASHBOARD

To *open* the Activity DASHBOARD, select the **Activity** icon ().

To *close* the Activity DASHBOARD, select the **Activity** icon ().

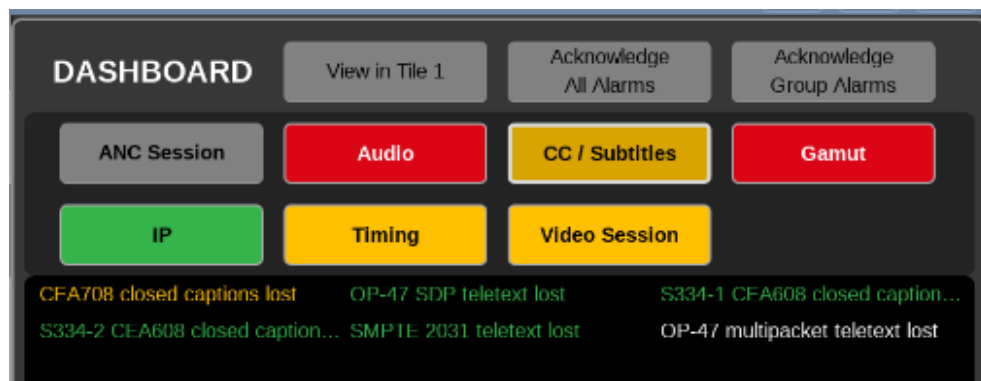

The alarm group buttons and the alarm titles are color-coded.

- The Group buttons (ANC Session, Audio, etc.) color coding:
 - A gray button means no alarms in the group are turned on in the DASHBOARD.
 - A green button means at least one alarm in the group is turned on but no alarms are active.
 - A yellow button means at least one alarm in the group has been activated but it has cleared.
 - A red button means at least one alarm in the group has been activated and it is still active.

Note: A red (still active) alarm takes precedence over yellow. If there are both active and cleared alarms in the group, the button is red.

- The alarm titles (below the group buttons) color coding:
 - A white title means the alarm is *not* turned on in the DASHBOARD.
 - A green title means the alarm is turned on in the DASHBOARD and the alarm is not active.
 - A yellow title means the alarm was activated but it has cleared.
 - A red title means the alarm was activated and it is still active.

Turn Alarms on or off in the DASHBOARD

Note: Turning alarms off means they are not tracked in the DASHBOARD or through the Activity icon. No color change or alarm occurs. The alarms are still logged in the Event Log application and sent to the Syslog server, if enabled.

1. In the status bar, select the **Settings** icon and then select **Alarms**.

2. Select the alarms to turn on in the DASHBOARD.

- To turn on a group or groups of alarms in the DASHBOARD, select the checkbox of any alarm group. To turn an alarm off, clear the checkbox.

	Threshold	Dashboard
ANC Session		<input checked="" type="checkbox"/>
Audio		<input type="checkbox"/>
CC / Subtitles		<input checked="" type="checkbox"/>
Gamut		<input type="checkbox"/>
IP		<input type="checkbox"/>
Timing		<input checked="" type="checkbox"/>
Video Session		<input checked="" type="checkbox"/>

- To turn on any specific alarm or alarms, select the title of a group of alarms to see the individual alarms and select the checkbox of any specific alarm. To turn an alarm off, clear the checkbox.

Alarm	Threshold	Dashboard
Audio Signal Lost	N/A	<input checked="" type="checkbox"/>
Audio Over error	>-2 dB for >1 s	<input type="checkbox"/>
Audio Pair Out Of Phase	<-30% for >1 s	<input checked="" type="checkbox"/>

- To set the thresholds for alarms (an alarm with N/A under Threshold does not have thresholds to set), select anywhere in the alarm line and select the up or down arrows to change the threshold settings.

Alarm	Threshold	Dashboard
Audio Signal Lost	N/A	<input checked="" type="checkbox"/>
Audio Over error	>-2 dB for >1 s	<input type="checkbox"/>
Duration <input type="text" value="1"/> s		
Max <input type="text" value="-2"/> dB		
Audio Pair Out Of Phase	<-30% for >1 s	<input checked="" type="checkbox"/>

Acknowledge Alarm Notifications

The notification of alarms can be acknowledged (set the alarms to green) through two methods in the Activity DASHBOARD:

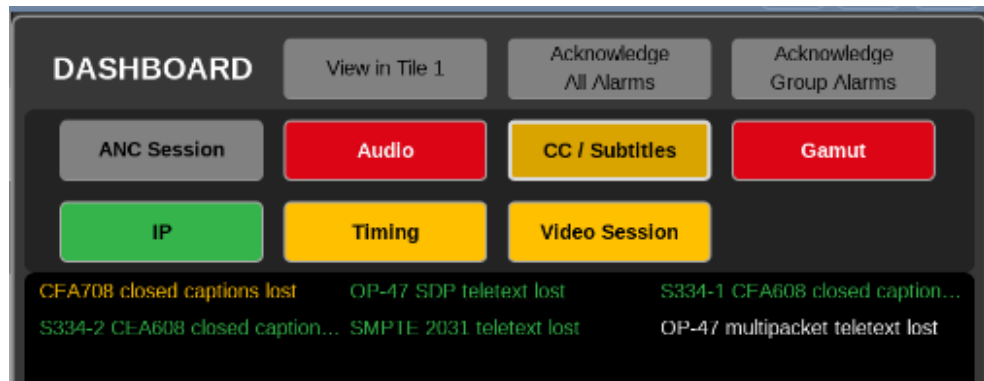

- To acknowledge all of the alarms in the DASHBOARD, at the top of the DASHBOARD, select **Acknowledge Alarms**.
All the alarms and all the group buttons are set to green, unless an alarm is still asserted, in that case the alarm, and the related group button, remains red.
- To acknowledge all of the alarms in the selected alarm group, at the top of the DASHBOARD, select **Acknowledge Group**.
All the alarms in the selected group and the group button are set to green, unless an alarm is still asserted, in that case the alarm, and the related group button, remains red.

Use the Alarm Groups

To choose an alarm group

Select the group button from the options below the DASHBOARD header (ANC Session, Audio, etc.).

The alarm group is circled in white and the alarms in that group appear below the group buttons.

To see the alarms in the Event Log application

Select **View in tile 1** at the top of the DASHBOARD.

- The Event Log application displays in tile 1.
- The errors are filtered by the group currently selected Dashboard Alarm Group.

To filter Event Log alarms by group

Select an alarm group and select **View in tile 1**.

Methods of Operation

This section describes the primary methods of operating the instrument:

- MPI front panel touchscreen
- MPX front panel controls
- External touchscreen display
- Keyboard and mouse
- Remote control using VNC
- Remote control using API commands

MPI Touchscreen Operation

The next illustration shows the PRISM display in four-tile mode with the All Application menu open.



Supported Touchscreen Gestures

Use these touchscreen gestures to control the instrument:

- Touch or tap the screen to select display elements.
- Double tap an application to change the display between a quarter-screen and a full-screen display or between a half-screen tile and a full-screen display of the selected application. Double tap a full-screen display to return to the quarter- or half-screen tile.
- Swipe up or down, or left or right as necessary to move through menus and preset listings and to view additional application information.
- Some applications support pinch and zoom.

Note: The terms “tap”, “swipe”, and “pinch” apply to the touchscreen on the instrument. If you are using a mouse and keyboard you must “click”, “scroll” and use the scroll wheel on the mouse.

Select and Control Application to Display

Open a different application in a tile:

1. In the Status bar, select the Tiles icon () to open the Application toolbar.



Note: The applications visible in the Applications toolbar can be changed by the user to any number of applications, up to eight, in any order.

2. Select a tile to replace with a different application.
3. Select an application from the application toolbar.
4. If an application is not on the application toolbar, select the All Application menu icon (⊞), on the right of the application toolbar.
5. Select the application from the All Application menu.

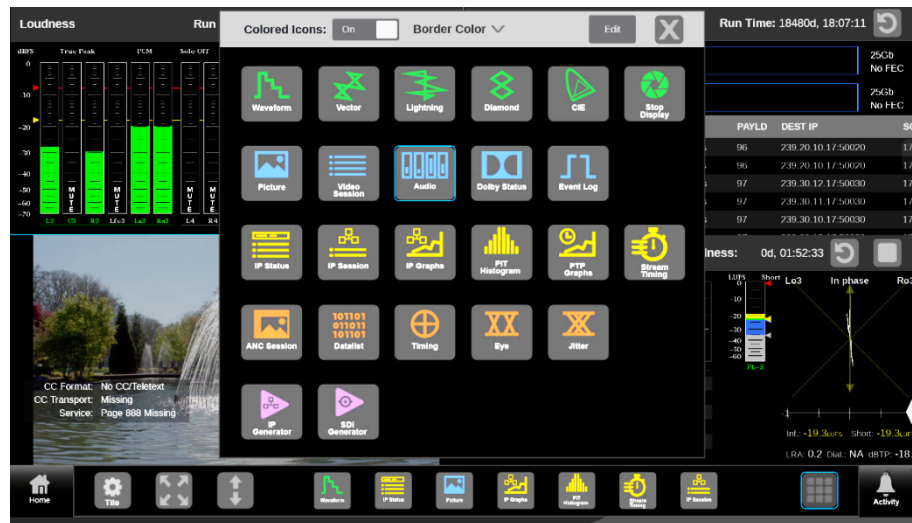

Note: The applications in the All Applications menu can vary depending on what options the user has ordered.

Change the Applications in the Application Toolbar

1. In the All Applications menu, select Edit from the menu header.
 - Select an application marked with a number to remove it from the application toolbar.

Note: Removed applications leave that space open in the Application toolbar only while the menu is in edit mode. If there is a space in the application list when the changes are saved, the applications are consolidated on the left and any spaces are moved to the right.

- Select Clear All to remove all the applications from the Application toolbar.
- Select an application that is not marked with a number to add it to an empty space in the application toolbar.

Note: The applications are added to the Applications menu from the left. If the number 2 and 3 spaces are empty, the next selected application is added to the number 2 space.

2. Select Save in the All Applications menu.

If you do not save the changes (if you select the Close icon (X) before saving) a warning appears asking if you want to save the changes. Select Ok to save the changes or Cancel to close the All Applications menu and return the Application toolbar to the layout before you selected Edit.

3. Select the Close icon (X).

Access an Application Settings Menu

1. Select the tile with the application.

2. Select the Tiles icon (Tiles) on the left of the application toolbar.

3. Select the Tile icon (Tile).

The application Settings menu is displayed.

Change the Design of the Interface (two options)

- In the All Applications menu header, select the Colored Icons On-Off button to turn the color of the application icons on or off (this includes the applications in the All Applications menu and the Applications menu).
- In the All Applications menu header, select Border Color to pull down the menu of color options for the border that highlights the selected tile. Select Blue, White, or Yellow as the color.

Change the Size of a Tile

- Select the Full-screen icon (Full) in the menu bar to change the selected application display to full screen, or double tap a tile.

When a tile is in full-screen-mode, select the Reduce icon (Reduce) in the menu bar to return to quarter- or half-screen mode. Double tap a full-screen application to return it to a quarter- or half-screen tile.

- Select the half-screen icon (Half) in the menu bar to change the selected tile to vertical extended mode. The tile increases to the height of the screen, covering the second tile above or below it.

The vertical extended mode is useful for when you want to view two application displays side-by-side. When a tile is in vertical extended mode, select the quarter-screen icon (Quarter) in the menu bar to return to quarter-screen mode.

- If available, select the Reset icon (Reset) to clear or reset the selected display.

On-screen Tools

Some settings for the Waveform, Vector, Lightning, and Stop Display applications are available outside the settings menu through on-screen tools. Applications with on-screen tools enabled have buttons on the top and bottom of the display that allow you to adjust the application settings. When first selecting one of the displays, a highlighted ring appears around each available on-screen tool such as Gain, Format, Sweep, Cursors and Position. For instructions on how to use each on-screen tool, see these application sections:

- [Waveform Application On-screen Tools](#)
- [Vector Application On-screen Tools](#)
- [Stop Display Application On-screen Tools](#)
- [Lightning Application On-screen Tools](#)

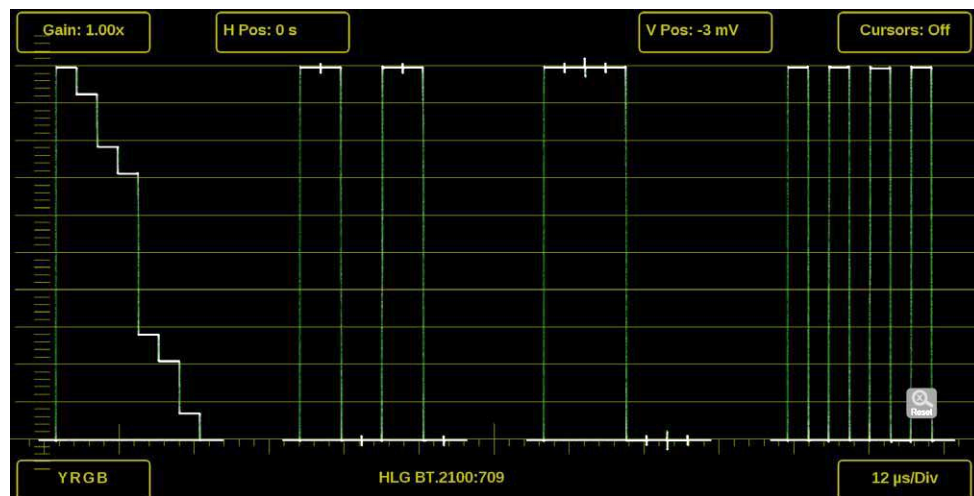

MPX Front-panel Controls

The next illustration shows the key controls on the front panel of the MPX. Descriptions of the elements are provided.



Descriptions of numbered PRISM MPX front-panel controls

Item number	Description
1	Power / Standby button: Press to turn the instrument on or off. To completely remove power from the instrument, remove the power cord.
<p> Caution: To prevent data loss, we strongly recommend you first shut down the instrument before disconnecting the power cord. Press Power / Standby or select Settings, Utilities, Power, and then Power Down Now.</p>	
2	BALANCE control: Turn to adjust the balance on the front and rear panel headphone and optional speaker outputs. Push the BALANCE control to re-center the balance. ¹
3	PRESET button: Press one time to prepare the instrument for a preset selection from preset Group A using the SELECTIONS buttons (1-6). Press the button repeatedly to select preset Group B-F. ¹
4	SELECTIONS buttons (1-6): After pressing the PRESET or INPUT button, press one of the SELECTIONS buttons (1-6) to recall an instrument preset or to select an input to monitor.
5	VOLUME control: Turn to adjust the volume on the front and rear-panel headphone outputs. Push the VOLUME control to mute or unmute the audio. ¹
6	Audio output: (1/4-inch—6.35mm—line out) port is for using headphones to listen to the selected audio channel pair.
7	USB ports: There are two USB 3.0 ports for connecting a mouse and keyboard, importing or exporting instrument presets, upgrading the instrument firmware, or saving screen and stream captures.

Descriptions of numbered PRISM MPX front-panel controls

8	INPUT button: Press to prepare the instrument for an input selection using the SELECTIONS buttons (1-6). ¹
9	Speakers: There are two integrated 2.1 speakers for listening to the selected audio channel pair. Requires Option SPKR.

1. When you use the PRESET and INPUT buttons, the associated menus appear on the display. The menus close after a short time-out period. Similarly, when you use the VOLUME or BALANCE control, the volume or balance slider and mute controls appear on the display and close after a short time-out period.

MPX Front Panel Operation

Use the instrument front panel to perform these functions:

- Recall instrument presets
- Select an input to monitor
- Control or mute the volume on the headphone and optional speaker outputs
- Adjust the balance on the headphone and optional speaker outputs
- Connect a mouse and keyboard
- Connect a USB drive to upgrade the instrument firmware or save screen and stream captures

Recall Instrument Presets

To recall instrument presets using the front panel:

1. Press the PRESET button one time to prepare the instrument for a preset selection from preset Group A using the SELECTIONS buttons (1-6).
2. Press the PRESET button repeatedly to select preset Group B-F. The selected preset group is displayed.
3. After you select the preset group, press the SELECTIONS numbered button corresponding to the preset in that group you want to recall (1-6).

Note: When you use the PRESET and INPUT buttons, the associated menus appear on the display. The menus close after a short time-out period. Similarly, when you use the VOLUME control, the volume slider and mute controls appear on the display and close after a short time-out period.

Select an Input to Monitor

To select an input to monitor using the front panel:

1. Press the INPUT button to prepare the instrument for an input selection.
2. Press the SELECTIONS numbered button corresponding to the input you want to monitor.

Keyboard and Mouse Operation

You can use a USB keyboard and mouse to operate the instrument. The mouse must have a scrolling wheel to access all of the menu selections. Click on applications to perform actions like you would on the touch panel.

Connect the keyboard and mouse:

- Use the USB ports on the rear panel of the instrument (MPI) or front panel (MPX).
- Use the USB port on the front of the optional dual rack cabinet (MPI-RACK-MM or MPI-RACK-MW).
- Connect the external monitor to any of the available display outputs, including Display Port or HDMI (MPX).

Keyboard Controls

Home Icon

The ESC key on the keyboard is mapped to function as the Home icon, which closes any displayed menus.

Volume Control

If your keyboard has volume control keys, you can use them to control the volume of the audio output on the instrument.

Input and Preset Selection

The next table lists the keyboard controls to quickly select between the SDI inputs and to select from instrument presets 1 through 6.

Keyboard Controls for Selecting SDI Inputs and Instrument Presets

Action	Keyboard control	Result
Input	ALT+i	Prepares the instrument for an input selection.
Preset	ALT+p	Prepares the instrument for a preset selection from preset Group A. Repeat 2-5 times to select preset Group B-F.
Select 1	1	Selects Input 1 or selects Preset 1 from the selected preset group.
Select 2	2	Selects Input 2 or selects Preset 2 from the selected preset group.
Select 3	3	Selects Input 3 or selects Preset 3 from the selected preset group.

Keyboard Controls for Selecting SDI Inputs and Instrument Presets

Select 4	4	Selects Input 4 or selects Preset 4 from the selected preset group.
Select 5	5	Selects Input 5 or selects Preset 5 from the selected preset group.
Select 6	6	Selects Input 6 or selects Preset 6 from the selected preset group.

To select an SDI input or instrument preset:

1. On the keyboard, do one of these options:
 - Press **ALT** and **i** at the same time to make an input selection change.
 - Press **ALT** and at the same time press **p** one time to recall a preset from Preset Group A. Press **p** 2-5 times to select a preset from another Preset Group (B-F). For example, press ALT and at the same time and press p three times to make a selection from Preset Group C.
2. Press a number from 1 to 6 to select the input or to select a preset from the selected Preset Group (A-F).

External Touchscreen Display Operation

You can use an external touchscreen display to control the instrument. Two connections are required:

- Connect the Display Port output from the PRISM monitor to the input on the external device.
- Connect the output of the external device to one of the USB ports on the PRISM monitor.



Note: A monitor with a 1920×1080 capable display works best with the instrument.

Note: We recommend you reboot the instrument after connecting an external touchscreen.

Manage Tile Display

Each application can be independently changed to quarter, half, or full screen based on your requirements. The default for the PRISM instrument is to display four quarter screen tiles. These configurations show how to expand the applications to half or full screen tiles and collapse them back to a quarter of the screen.

Half-Screen Tiles

There are several half screen configurations. Select the Tiles icon () and then select the expand icon () to enlarge the tile vertically.

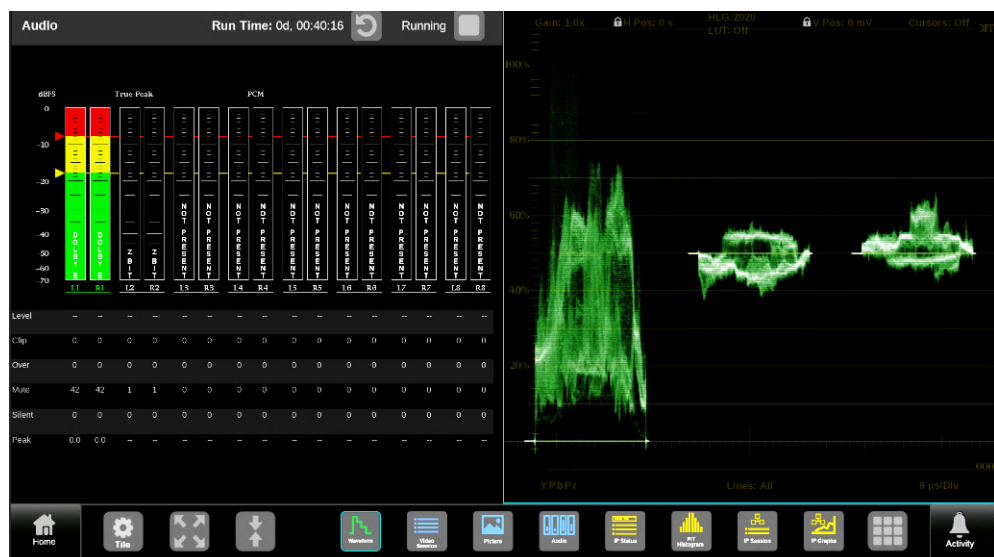
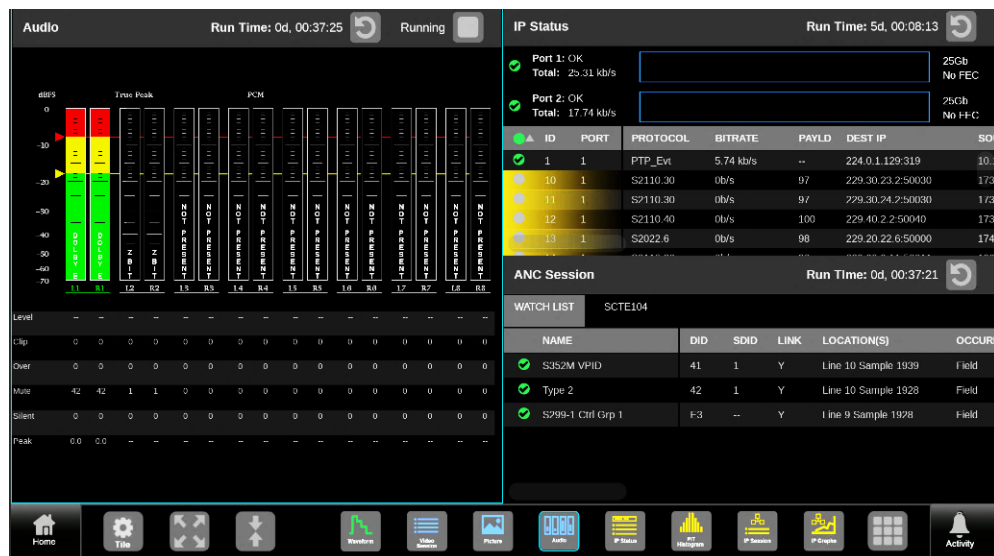

Full-screen Tile

One tile has expanded to use the entire PRISM monitor. There are two ways to change to and from full-screen mode.

- Double tap on the application to change it between full-screen and quarter- or half-screen mode.
- Select the **Tiles** icon (🗪) to open the application toolbar and select the quarter-screen icon (🗪) or the full-screen icon (🗪) to change between views.

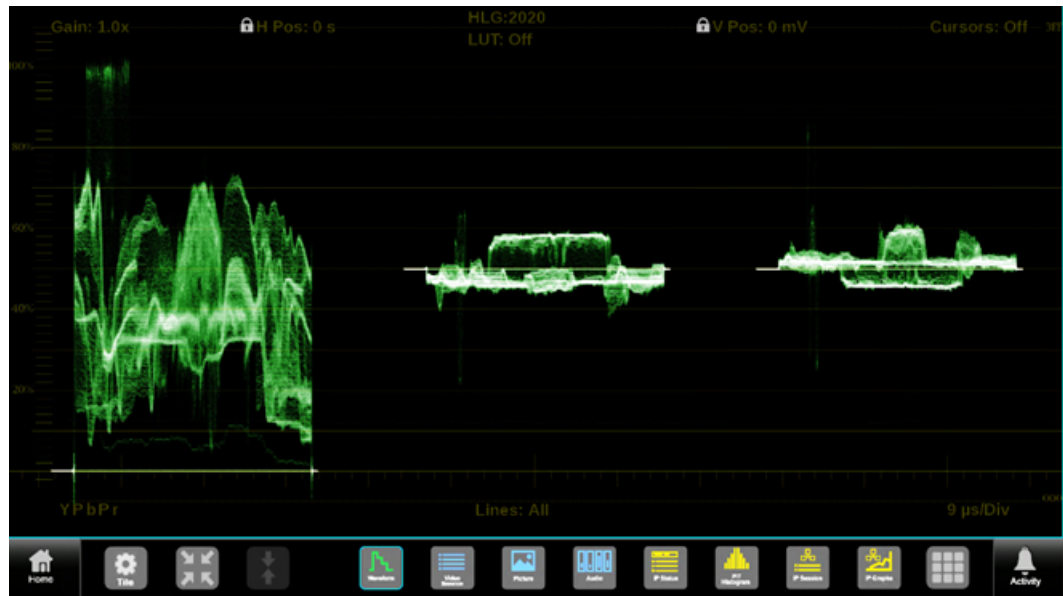

Quarter-screen Tiles

Sizing tiles to a quarter screen allows you the flexibility to view up to four tiles at the same time. There are two ways to change between quarter-screen mode and larger displays:

To expand a tile to the entire monitor (full-screen mode):

- Double click or double tap an application to change between quarter-screen tile and full-screen mode.
- Select the **Tiles** icon (🗪) to open the application toolbar and select the quarter-screen icon (🗪) or the full-screen icon (🗪) to change between modes.

To extend a tile vertically (half-screen mode):

- In the application toolbar, select the expand icon (⌵) to expand the tile vertically;
- Select the compress icon (⌶) to collapse the tile to a quarter-screen.



Remote Control through VNC Operation

When the PRISM monitor is connected to an Ethernet network, you can use a computer connected to the same network to remotely control the instrument in a web browser or in a VNC client such as VNC Viewer. Connect to the PRISM monitor by using VNC:

VNC client

When using VNC for extended periods of time, we recommend using a VNC client:

1. On the PRISM monitor to connect to, select the **Settings** icon () and then select **Network**.
2. Find the Control IP Port IP address of the instrument.
3. On your computer, open your VNC client and enter the IP address from the Control IP Port of the instrument in the VNC Server search bar.

The VNC client connects to the instrument in a separate window that appears exactly like the instrument display.

Note: A unique PRISM hostname can be used instead of the IP address.

Set a Hostname

1. Sign into the unit.
2. Select the **Settings** icon () , select **Network**, and then select the **WEB REMOTE** tab.
3. Enter the new hostname.in the Hostname field.

Web Browser

To connect to the instrument through a web browser:

1. On the PRISM monitor to connect to, select the **Settings** icon () , then select **Network**, and find the Control IP Port IP address of the instrument.
2. Enter the hostname or IP address in a web browser.

The PRISM HOME page displays.

3. Select **noVNC Access**.

A login webpage displays.



4. In the Control bar, select the Settings icon (⚙️) to open the Settings menu.

5. In the Settings menu, use the Scaling Mode drop-down list to select **Local Scaling**, and then select **Apply**.

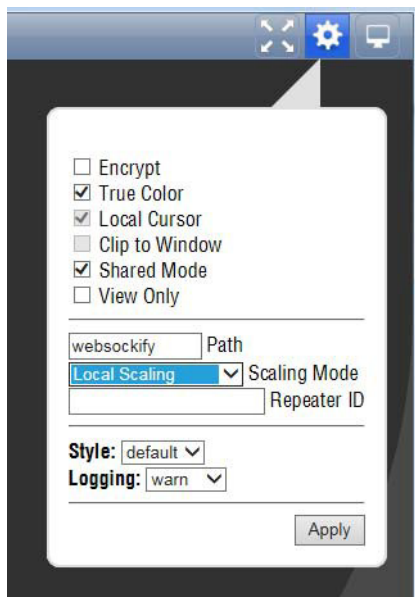

6. In the Control bar, select the Connect icon (🖥️) to open the Connect menu.

7. In the Settings menu, enter the password for the PRISM, and then select **Connect**.

Note: To change the default password for the remote web connection, in the PRISM Settings, in the Network menu, open the WEB REMOTE tab.

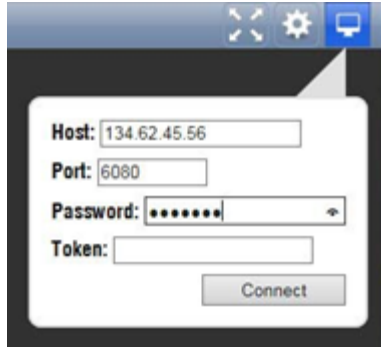

The web browser connects to the instrument with the browser display appearing exactly like the display on the external monitor, but with a slower update rate.

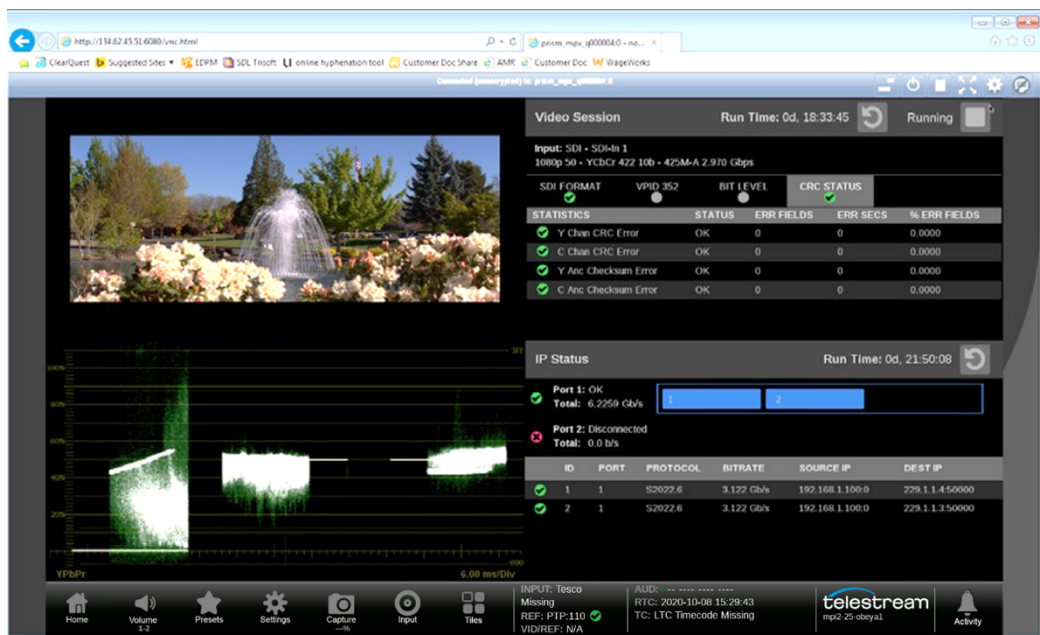

Note: If the correct Scaling Mode to Local Scaling is not selected, you must disconnect using the computer icon at the top of the viewer to gain access the Settings menu.

Remote Control through API Commands

The PRISM monitor has a command set for controlling the instrument using REST-style API commands. You can use GET and POST commands to configure the signal inputs and to select the active input.

Access the API Documentation

1. Find the PRISM hostname: on the Status bar, under the Telestream logo, next to the Activity icon.

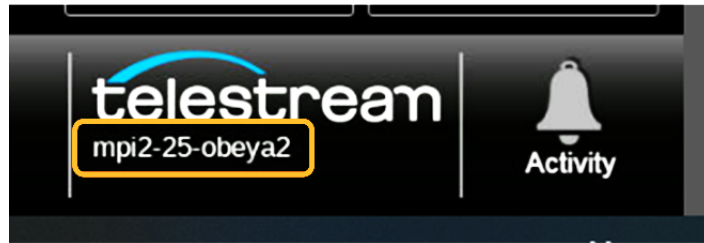

Or find the IP address: select **Settings**, then **Network**, and under CONTROL IP PORT find the IP Address.

2. Enter the hostname or IP address in a web browser.
The PRISM HOME page displays.
3. Select **API Help Page**.
4. If you have set a unique hostname for the instrument, enter it in the browser address bar and select the API Help Page link.
A PRISM API Documentation web page similar to the sample displays.

PRISM API DOCUMENTATION

Choosing a Scope:

To send a scope with an API request add a slash followed by the desired scope to the URL.
Example: localhost:9000/api/API_NAME/SCOPE

Selecting a field in a returned object:

If a GET request returns an object, a specific member can be selected by adding a field query to the URL. To access a member enter the path to it, starting with "object" and separated by ".".
Example: localhost:9000/api/API_NAME?field=object.parent1.parent2.target

NAME	MODE	DATATYPE/PARAMETERS	DESCRIPTION
anc_session_control	GET / POST	ints	Reset anc session. Option: ANC_ENGINE_SESSION_CONTROL_RESET.
audio_ballistic	GET / POST	ints	Ballistic Type for Audio Bars. Available Options: AUDIO_BALLISTIC_PPM_1, AUDIO_BALLIST
loudness_loud_level	GET / POST	floats	Loudness loud level, valid range is in between 0 to -30
loudness_quiet_level	GET / POST	floats	Loudness quiet level, valid range is in between 0 to -60
loudness_target_level	GET / POST	object	Loudness target levels as part of JSON Object. An example of Loudness target levels <pre>{ "target" : Target threshold in LKFS (Loudness units), Valid Range is in between 0 to -31dB "targetLow" : Relative Offset below the target level, (In Loudness Unit(LU): Ranges from 0.0 t "targetHigh" : Relative Offset above the target level, (In Loudness Unit(LU): Ranges from 0.0</pre>
audio_program_surround_order	GET / POST	ints	Select audio program surround order. Available Options: AUDIO_PROGRAM_SURROUND_OR

Syslog

PRISM supports Syslog protocol (RFC 5424) for alarms and events.

Setup Syslog

1. Select the **Settings** icon () to open the Settings menu.
2. select **Network**, and select **REMOTE ACCESS**.

Settings > Network
⌂ ✕

	STATUS	CONTROL IP PORT	VIDEO IP PORT	REMOTE ACCESS	NMOS
Hostname				mpi2-25	
Password				PRISM	
SYSLOG SETUP					
Syslog Server Address				10.101.3.116	
Syslog Server Port				514	
Syslog Set				Clear Save	

3. Fill in Syslog Server Address with the IP address of the computer running the syslog server software.
4. Fill in Syslog Server Port with the number configured in the syslog server software.

Note: For questions on configuring your syslog server software, contact your system admin.

5. Select **Save**.

The syslog server software collects events and alarms, and displays the details.

Date	Time	Priority	Hostname	Message
03-12-2021	17:01:49	User.Info	10.101.3.118	Mar 12 16:52:27 mpi2-25-mastercontrol Prism[2228]: Audio Pair Out Of Phase :: Clear at time 2021-03-13 00:52:27 timecode 01:00:29:27 (LTC)
03-12-2021	17:01:48	User.Info	10.101.3.118	Mar 12 16:52:26 mpi2-25-mastercontrol Prism[2228]: Video signal lost :: Clear at time 2021-03-13 00:52:27 timecode 01:00:29:11 (LTC)
03-12-2021	17:01:48	User.Error	10.101.3.118	Mar 12 16:52:26 mpi2-25-mastercontrol Prism[2228]: Video signal lost :: Set at time 2021-03-13 00:52:27 timecode 01:00:29:11 (LTC)
03-12-2021	17:01:48	User.Error	10.101.3.118	Mar 12 16:52:26 mpi2-25-mastercontrol Prism[2228]: Audio Pair Out Of Phase :: Set at time 2021-03-13 00:52:26 timecode 01:00:28:29 (LTC)
03-12-2021	17:01:48	User.Info	10.101.3.118	Mar 12 16:52:26 mpi2-25-mastercontrol Prism[2228]: Audio Signal Lost :: Clear at time 2021-03-13 00:52:26 timecode 01:00:28:28 (LTC)

SNMP Traps

PRISM supports SNMP only for alarms (traps). PRISM supports a single trap prefix (prismTrap), which can be seen in the Video signal lost sample. The SNMP configuration is created through the RESTful API.

- The alarm is identified in the SNMP trap payload.
- The PRISM SNMP MIB is provided in the file prism_mon.mib file, which can be downloaded from the PRISM web page.
- SNMP trap destination address is set with RESTful API using post operation, through Postman or a similar application.
- The alarms generated in the PRISM are sent to the destination trap receiver as SNMP trap.
- Users must have a trap receiver running on the destination machine and the IP address of the PRISM (snmpAgent) need to be configured on the destination.

Enable SNMP Traps

Note: To open the PRISM help page, go to <http://IpAddress/api/help> (replace "IpAddress" with your PRISM IP address).

Note: To set the SNMP_TRAP_ENABLE_ON you need an API development application, such as Postman.

1. In a PRISM open an API development application, such as Postman.
 - GET and POST are allowed commands.
 - In these examples, replace "xxx.xxx.xxx.xxx" with the IP address of the PRISM the sending the traps and "yyy.yyy.yyy.yyy" with the IP address of the computer receiving the traps.

2. Set the SNMP_TRAP_ENABLE_ON:
 - a. Enter the IP address of the unit xxx.xxx.xxx.xxx/api/snmp_trap_enable.
 - b. In the body of the JSON command, enter:

```
{  
  "ints": [  
    "SNMP_TRAP_ENABLE_ON"  
  ]  
}
```
 - c. Execute as a POST operation.
3. Set the trap destination address:
 - a. Enter command xxx.xxx.xxx.xxx/api/snmp_trap_destination_address.
 - b. In the body of the JSON command, enter:

```
{  
  "string": "yyy.yyy.yyy.yyy"  
}
```
 - c. Execute as a POST operation.

Check the Traps

1. Download the prism_mon.mib from the PRISM web page.
 - a. Open the PRISM instrument home page.
 - b. Enter the PRISM IP address in a browser.
 - c. Select **SNMP** in the PRISM menu.
 - d. Select **Download**.

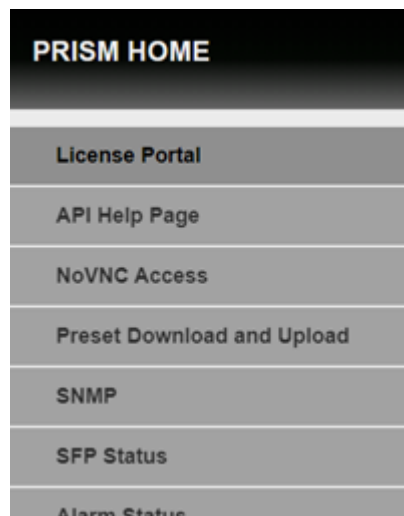

2. Install any SNMP manager on the machine where you want to check the traps.
 - a. From the SNMP manager, configure the SNMP agent (PRISM) IP address.
 - b. Load the prism.mib file.
 - c. Open the trap receiver window.
 - d. Confirm the traps are received on the trap receiver window of the MIB browser application on the destination machine (on port 162).

```
⊕ Trap [V2], 12-15-2020 20:46:46, 10.101.3.58, prismTrap
⊖ Trap [V2], 12-15-2020 20:46:47, 10.101.3.58, prismTrap
  --- Community String = public
  --- Request = 380089371
  --- 1.3.6.1.4.1.47445.1.2.1.1. = Video signal lost
  --- 1.3.6.1.4.1.47445.1.2.1.1.0.1 = 1.3.6.1.4.1.47445.1.2.1.1.0.1
  --- 1.3.6.1.4.1.47445.1.2.1.1.2 = alarmStart (1)
  --- 1.3.6.1.4.1.47445.1.2.1.1.3 = 04:46:30
```

Configure the Instrument

Most of the instrument settings are controlled using the Settings menu. To access the global settings menu, select the **Settings** icon () in the status bar. This section describes how to configure these instrument settings:

- Signal inputs: [Configure and Select Signal Inputs](#)
- HDR monitoring: [Configure Instrument for HDR/WCG Monitoring](#)
- PTP reference settings: [Configure Reference Settings](#)
- Presets: [Set and Recall Instrument Presets](#)
- Internal time and date: [Set Time and Date](#)
- Firmware upgrade: [Upgrade Instrument Firmware](#)
- Installed software and hardware versions: [Verify Firmware Upgrade](#)

Note: Some of the configuration settings require you to enter values. A USB keyboard can be used to enter these values instead of using the touchscreen keypad on the instrument.

Configure and Select Signal Inputs

The PRISM monitor allows you to configure multiple signal inputs.

Select **Settings**, and then select **Inputs** menu for options:

- configure SDI inputs
- turn on Edit Mode
- configure IP stream inputs, including ST2022-6 and ST2110-20/30/40 and RTP streams
- modify input names
- enable ST2022-7 Seamless Switching

The input selection of the PRISM is displayed in the middle of the status bar. The first line is the user defined name and the second line is the format.

 **Caution: IGMP communications can fail when the Video IP Ports are configured for the same IP Address. The control port and both video ports should always have different IP addresses and be on different subnets.**

Configure SDI Inputs

Note: Quad link SDI is only available when software option MP2-FMT-4K or MP2-FMT-8K is present. If this option is not present, only a single-link input can be configured.

Single Link Input Configuration

1. Select the **Settings** icon () to open the Settings menu.
2. Select **Inputs** to open the inputs submenu.
3. Select an input and then select **SDI**.



Note: The virtual inputs can be given any meaningful name.

4. Select **Single** for the Input Configuration and select one of the four physical SDI inputs to monitor.



Select Video Settings

These settings are the same for Single and Quad Link input configurations. The Gamma and Color Gamut settings define the characteristics of the video signal.

Note: The preferred setting for all video options is Auto. At this setting the PRISM determines the correct settings from the signal or any metadata (if present).

1. Select Video.



2. Choose the Format option from the drop-down menu:

- Auto: The system selects the correct setting based on the information in the incoming signal.
- 525I
- 625I
- 720P
- 1080I
- 1080PsF
- 1080P
- 2160P

3. If a 3-gigabit transport is being used, select the In 3G-SDI drop-down menu and choose:

- Auto: The system selects the correct setting based on the information in the incoming signal.
- Level A
- Level B

4. Choose the Gamma Curve option from the drop-down menu. The selection characterizes the video signal on each virtual input.
 - Auto: The system selects the setting based on ST352 VPID. If ST352 VPID is not present, SDR Narrow is selected.
 - SDR Narrow: The reference OETF (Optical to Electrical Transfer Function) is defined in ITU-R BT.709 with gamma of 0.45 and the reference EOTF is defined in ITU-R BT.1886 with gamma of 2.4.
 The Narrow scaling places the extremes of the nonlinear color value from zero to unity at code words 40 hex (64 dec) and 3AC hex (940 dec) in a 10bit representation for 0% Black to 100% White. This range is typical for standard-dynamic range.
 - SDR Full: The reference OETF (Optical to Electrical Transfer Function) is defined in ITU-R BT.709 with gamma of 0.45 and the reference EOTF (Electrical to Optical Transfer Function) is defined in ITU-R BT.1886 with gamma of 2.4.
 The full scaling places the extremes of the nonlinear color value from zero to unity at code words 0d and 1023d in 10bit representation and 0d and 4095d in 12bit representation for 0% black and 100% white, respectively.
 - PQ Narrow: The reference OETF with a high luminance range capability of 0 to 10,000 cd/m² standardized in SMPTE2084. The EOTF is the inverse of OETF.
 The narrow scaling places the extremes of the nonlinear color value from zero to unity at code words 40 hex (64 dec) and 3AC hex (940 dec) in a 10bit representation for 0% Black to 100% White. This range is typical for standard-dynamic range.
 - PQ Full: The reference OETF with a high luminance range capability of 0 to 10,000 cd/m² standardized in SMPTE2084. The EOTF is the inverse of OETF.
 The full scaling places the extremes of the nonlinear color value from zero to unity at code words 0d and 1023d in 10bit representation and 0d and 4095d in 12bit representation for 0% black and 100% white, respectively.
 - HLG: The reference OETF is standardized in ARIB B67 and the reference EOTF is standardized in ITU BT.2100 at the nominal display peak luminance of 1000 nits.
 - S-Log2: The reference OETF is defined as Sony S-Log2. The EOTF is the inverse of OETF.
 - S-Log3: The reference OETF is defined as Sony S-Log3. The EOTF is the inverse of OETF.
 - S-Log3 (Live HDR): The reference OETF (Optical to Optical Transfer Function) is defined as Sony S-Log3.
 - Log C: The reference OETF is defined as ARRI Log C. The EOTF is the inverse of OETF.

Note: The Structure option is set to Auto.

5. Choose the Color Gamut option from the drop-down menu to select the color space of the video signal selection:
 - Auto: The system selects the setting based on ST352 VPID. If ST352 VPID is not present, Rec. 709 is selected.
 - Rec. 709: Standard for HD
 - Rec. 2020: Standard for 4K

Note: Rec. 709 gamut is automatically selected when the SD format is detected / selected in the video signal.

Select Audio Settings

The Audio settings define how the audio is embedded in the SDI input signal.

These settings are the same for Single and Quad Link input configurations, except the Quad Link, which is intended for 8K, can have 32 channels, instead of 16, in Program Configuration.

1. Select **AUDIO**.



2. Choose the type of audio. *Select PCM* or *Select DOLBY* (use of Dolby requires the MP2-DLBY license).

Select PCM

- a. Select **Program Configuration**.
- b. Move the Program Configuration slider to **On**.
- c. Select **Edit**.

The Edit button disappears and the Default, Clear, and Undo buttons replace it.

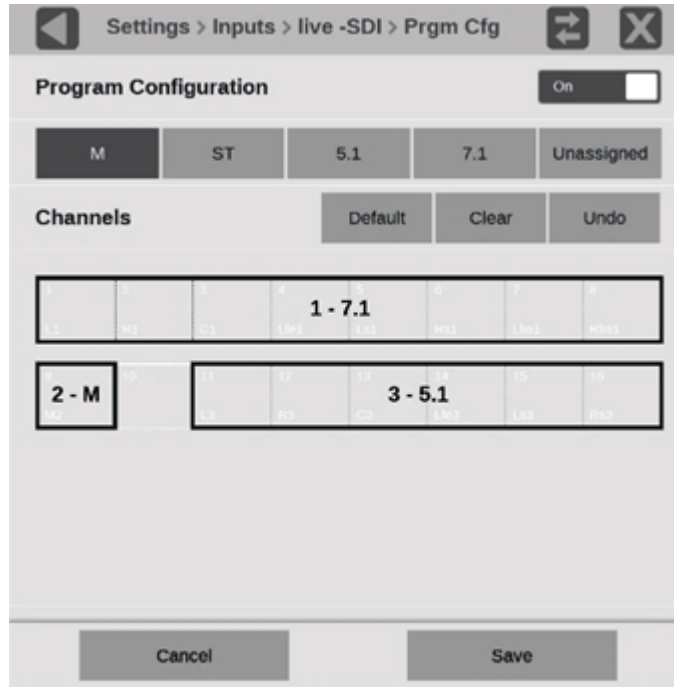

Note: Quad Link is intended for 8K and can have 32 channels, instead of 16, in Program Configuration.

- d. Select the type of program (mono, stereo, etc.) and select the audio channel to assign it. Repeat until all the audio in the current input signal have programs assigned to channels.

M is mono, 1 channel.

ST is stereo, 2 channels.

5.1 is surround sound, 6 channels.

7.1 is surround sound, 8 channels.

Unassigned removes an assignment from a channel. Click **Unassigned** and click any block in an assignment, for example the middle of a 7.1 assignment, the entire assignment is removed and is not displayed on the Audio application.

Default resets the channels to 8 stereo pairs.

Clear removes all assignments, including the default.

- e. Select **Save** and close the menu.

Note: You must save the program configuration to update the programs in the audio bars and loudness meter.

Select DOLBY

Note: Dolby D Plus and E are available in SDI and 2022.

- a. Select **DOLBY**.

- b. In the Dolby Audio Channel Pair menu, select the audio channel pair that contains Dolby audio.

Dolby audio in the selected channels are then decoded. Only Dolby D/D Plus/E decode is supported.

- c. Select **Save** and close the menu.

Note: Audio programs configured in the Program Configuration menu are used to select a program for measurement by the Loudness application, to display audio bars in the Audio application, and to monitor with headphones. When all the channels are unassigned, all the channels are treated as stereo pairs. The audio programs in the Dolby stream are automatically set up based on the Dolby metadata.

Quad Link Input Configuration

Note: All four SDI inputs must be connected to a cable on the back of the PRISM to use Quad Link Inputs.

1. Select the **Settings** icon () to open the Settings menu.
2. Select **Inputs** to open the Inputs submenu.
3. Select an input and then select **SDI**.
4. Confirm that Quad Link cables are connected to the back of the instrument.
 - Quad Link A is connected to SDI-IN 1
 - Quad Link B is connected to SDI-IN 2
 - Quad Link C is connected to SDI-IN 3
 - Quad Link D is connected to SDI-IN 4
5. Select **Quad Link** for the Input Configuration. SDI 1-4 (Link A-D) is selected by default.



Note: The Quad Link and UHD/4K Mode buttons are only available when software option MP2-FMT-4K is present.

6. Use the UHD/4K Mode buttons to select **Auto**, **Sq Div** (Square Division) or **2 SI** (Two Sample Interleave).
7. [Select Video Settings.](#)
8. [Select Audio Settings.](#)

Note: In AUTO mode, the instrument defaults to Two Sample Interleave mode if the Video Payload Identifier (VPID) complies with SMPTE 425.3 or SMPTE 425.5. The instrument defaults to Square Division mode if the VPID complies with SMPTE 292.1, SMPTE 372, SMPTE 425.1, or a quad-HD signal is present and VPID is missing. VPID in the signal is required for this option to operate properly.

9. Select **Save** and close the menu.

Note: The 8K format trace applications—Waveform, Stop, Vector, Diamond, and Lightning Displays, enabled by MP2-FMT-8K—are rendered based on the resized 8K signal and are suitable for operational applications such as setting camera exposure

for live programming. However, this approach may not be suitable for some engineering applications. This approach only impacts 8K formats and not SD/HD/3G/4K formats in either operations or engineering.

Rename a Signal Input

1. Select the **Name** box to open the text editing display.

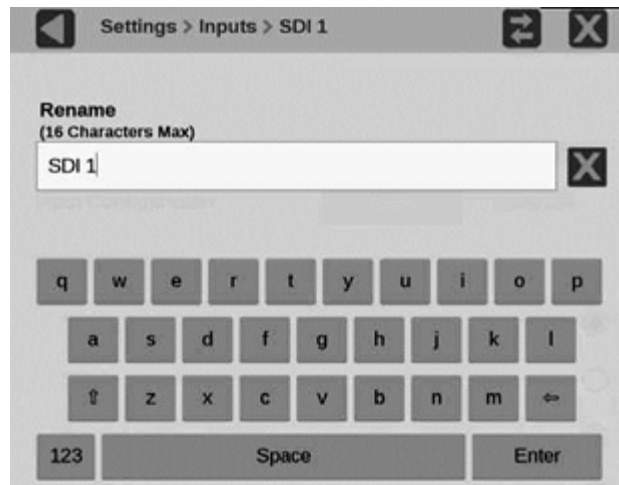

2. Use the editing controls to enter a new name for the input. Some notes on using the text editor:
 - Enter a name with a maximum of 16 characters.
 - Select the Clear icon (X) next to the input box to remove the existing name. Use the **shift** key to access capital letters.
 - Use the **backspace** key to delete characters by backspacing over them.
 - Use the **123-abc** key to change between accessing letters and numbers/symbols.
3. When you are done editing the input name, select the **Enter** key.
4. When you are done editing the input, select **Save** to save your changes.

Configure IP Stream Inputs

Configure and Monitor ST2022-6

1. Select the **Settings** icon (⚙️) to open the Settings menu.
2. Select **Inputs** to open the Inputs submenu.
3. Select the input from the list.

4. Select **IP**.

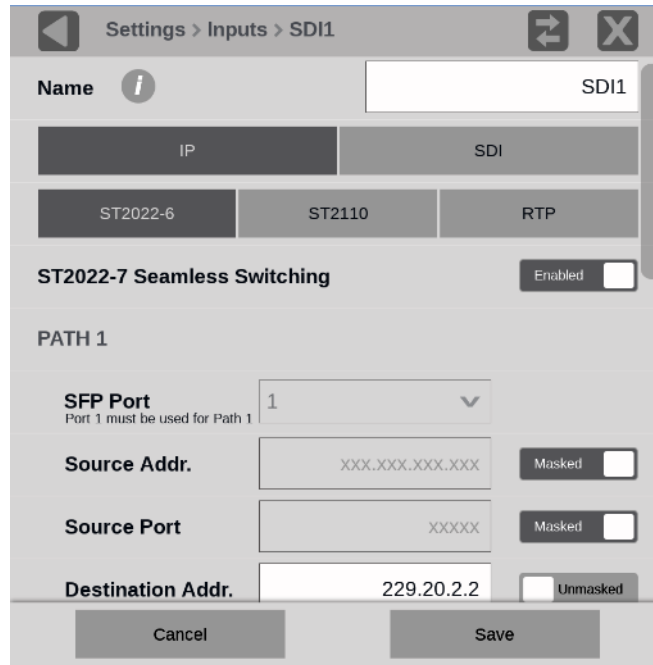

5. Select **ST2022-6**.

6. Slide the ST2022-7 Seamless Switching control to Enabled or Disabled.

Note: There is a difference between “port” and “path”. The port is the physical SFP port that is used to input the 10/25GE signal. Path 1 and Path 2 are the signal paths to be used for seamless switching. This differentiation is being made because it is possible for both Path 1 and Path 2 to use a single port.

Note: With ST2022-7 seamless switching, a reconstructed output stream is created from the two input streams. The reconstructed stream is used downstream for various display tiles like Picture. The buffer size to absorb the packet reception time difference between Path1 and Path2 is 10ms. The output stream reconstruction does not work properly for streams on Path1 and Path2 with skew greater than 10ms. This error makes tiles show the wrong images and information.

7. Enter the Source and Destination information for Path 1 and Path 2, if applicable.

Note: Path 2 is only available if ST2022-7 Seamless Switching is enabled. You may have to scroll down to see Path 2.

8. To have the instrument ignore a parameter, select the **Unmasked** control next to the parameter to change the state to Masked.

9. To edit one of the parameter values, select inside the parameter box to open the editing display.



10. When you are done editing, select **Enter**.
11. Scroll down to enter the Source and Destination information for Path 2.

Select Video Settings

The Gamma and Color Gamut settings are the same for ST2022-6 and ST2110 video stream configurations, but the ST2110 menu has a different layout. The settings define the characteristics of the video signal.

1. Choose the Gamma Curve setting from the drop-down menu.
The selection characterizes the video signal on each virtual input.

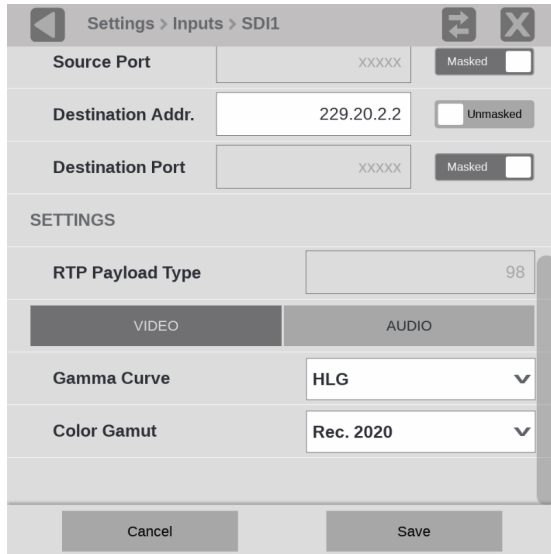

- SDR Narrow: The reference OETF (Optical to Electrical Transfer Function) is defined in ITU-R BT.709 with gamma of 0.45 and the reference EOTF (Electrical to Optical Transfer Function) is defined in ITU-R BT.1886 with gamma of 2.4.

The Narrow scaling places the extremes of the nonlinear color value from zero to unity at code words 40 hex (64 dec) and 3AC hex (940 dec) in a 10bit representation for 0% Black to 100% White. This range is typical for standard-dynamic range.

- SDR Full: The reference OETF (Optical to Electrical Transfer Function) is defined in ITU-R BT.709 with gamma of 0.45 and the reference EOTF (Electrical to Optical Transfer Function) is defined in ITU-R BT.1886 with gamma of 2.4.

The full scaling places the extremes of the nonlinear color value from zero to unity at code words 0d and 1023d in 10bit representation and 0d and 4095d in 12bit representation for 0% black and 100% white, respectively.

- PQ Narrow: The reference OETF (Optical to Electrical Transfer Function) with a high luminance range capability of 0 to 10,000 cd/m² standardized in SMPTE2084. The EOTF (Electrical to Optical Transfer Function) is the inverse of OETF.

The narrow Scaling places the extremes of the nonlinear color value from zero to unity at code words 40 hex (64 dec) and 3AC hex (940 dec) in a 10bit representation for 0% Black to 100% White. This range is typical for standard-dynamic range.

- PQ Full: The reference OETF (Optical to Electrical Transfer Function) with a high luminance range capability of 0 to 10,000 cd/m² standardized in SMPTE2084. The EOTF (Electrical to Optical Transfer Function) is the inverse of OETF.

The Full scaling places the extremes of the nonlinear color value from zero to unity at code words 0d and 1023d in 10bit representation and 0d and 4095d in 12bit representation for 0% black and 100% white, respectively.

- HLG: The reference OETF is standardized in ARIB B67 and the reference EOTF is standardized in ITU BT.2100 at the nominal display peak luminance of 1000 nits.
- S-Log2: The reference OETF is defined as Sony S-Log2. The EOTF is the inverse of OETF.
- S-Log3: The reference OETF is defined as Sony S-Log3. The EOTF is the inverse of OETF.
- S-Log3 (Live HDR): The reference OETF (Optical to Optical Transfer Function) is defined as Sony S-Log3.
- Log C: The reference OETF is defined as ARRI Log C. The EOTF is the inverse of OETF.

2. Select Color Gamut settings in the drop-down menu.

The selection is the color space of the video signal.

- a. Rec. 709: Standard for HD.
- b. Rec. 2020: Standard for 4K.

Note: Rec. 709 gamut is automatically selected when the SD format is detected or selected in the video signal.

Select Audio Settings

1. Select **AUDIO**.

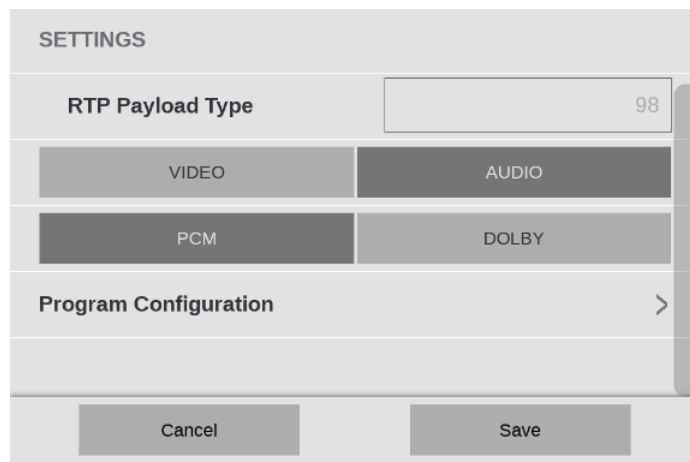

2. Choose the type of audio. [Select PCM](#) or [Select DOLBY](#) (use of Dolby requires the MP2-DLBY license).

Select PCM

- a. Select **Program Configuration**.
- b. Move the Program Configuration slider to **On**.
- c. Select **Edit**.

The Edit button disappears and the Default, Clear, and Undo buttons replace it.



- d. Select the type of program (mono, stereo, etc.) and select the audio channel to assign it. Repeat until all the audio in the current input signal have programs assigned to channels.

M is mono, 1 channel.

ST is stereo, 2 channels.

5.1 is surround sound, 6 channels.

7.1 is surround sound, 8 channels.

Unassigned removes an assignment from a channel. Click **Unassigned** and click any block in an assignment, for example the middle of a 7.1 assignment, the entire assignment is removed and is not displayed on the Audio application.

Default resets the channels to 8 stereo pairs.

Clear removes all assignments, including the default.

- e. Select **Save** and close the menu.

Note: You must save the program configuration to update the programs in the audio bars and loudness meter.

Select DOLBY

Note: Dolby D Plus and E are available in SDI and 2022.

- a. Select **DOLBY**.
 - b. In the Dolby Audio Channel Pair menu, select the audio channel pair that contains Dolby audio.
Dolby audio in the selected channels are then decoded. Only Dolby D/D Plus/E decode is supported.
 - c. Select **Save** and close the menu.
-

Note: Audio programs configured in the Program Configuration menu are used to select a program for measurement by the Loudness application, to display audio bars in the Audio application, and to monitor with headphones. When all the channels are unassigned, all the channels are treated as stereo pairs. The audio programs in the Dolby E stream are automatically set up based on the Dolby D/D Plus/E metadata.

3. To begin monitoring this input, select the configured input. (See [Select Input.](#))

Configure and Monitor ST2110

1. Select the **Settings** icon () to open the Settings menu.
2. Select **Inputs** to open the Inputs submenu.
3. Select the input from the list.
4. Select **IP**.
5. Select **ST2110**.
6. Slide the NMOS control to Enabled or Disabled.

Enabling NMOS allows system management software to discover, register, configure the input, and select the active input for monitoring.

Note: NMOS Discovery and Registration must be enabled in the network settings for this control to be available. (See [Enable NMOS Discovery and Registration.](#))

7. Slide the Seamless Switching control to Enabled or Disabled.
-

Note: For Seamless Switching, the two Path 1 and Path 2 streams should be identical. If the streams are not identical, error messages are shown in the Status Bar. There is a difference between “port” and “path”. The port is the physical SFP port that is used to input the 10GE signal. Path 1 and Path 2 are the signal paths to be used for seamless switching.

Note: With Seamless Switching, a reconstructed output stream is created from the two input streams. The reconstructed stream is used downstream for various display tiles like Picture. The buffer size to absorb the packet reception time difference between Path1 and Path2 is 10ms. The output stream reconstruction does not work properly for streams on Path1 and Path2 with skew greater than 10ms. This error makes Picture tiles show the wrong image.

8. Configure the Video (2110-20) stream tab:
 - a. Select the **Video** tab.
 - b. Move the Enable Video slider to **Enabled** to begin configuration.

- c. Enter the information in SFP Port, Source Addr, Source Port, Destination Addr, and Destination Port for each video stream.
- d. Set the RTP Payload Type between 96 and 127.
- e. Set the Packet Read Schedule (PRS) to Gapped, Narrow Linear, or Wide Linear to correctly measure the CMAX and VRX buffer measurements in the IP graphs.

Note: The PIT Histogram can be used to determine if the signal is a gapped, narrow-linear, or wide-linear stream.

- f. Set the TR Offset, which defines the timing reference offset of the sender for network delays. Select Auto to provide an offset based on the current video standard.
 - g. Select the Gamma Curve and Color Gamut settings for the video stream. See [Select Video Settings](#) for information on available Gamma and Gamut selections.
9. Configure the Audio (2110-30) stream tab:

Note: To decode Audio (2110-30) stream, it's necessary for Video (2110-20) to be available and subscribed.

a. Select the **Audio** tab.

The screenshot shows a configuration window titled 'Settings > Inputs > SDI1'. At the top, there are three tabs: 'Video (2110-20)', 'Audio (2110-30)', and 'Data (2110-40)'. The 'Audio' tab is selected. Below the tabs, there is a section for 'Enable Audio' with a slider set to 'Enabled'. Underneath is the 'AUDIO PATH' section, which contains several fields: 'SFP Port' (a dropdown menu set to '1'), 'Source Addr.' (a text field with 'xxx.xxx.xxx.xxx' and a 'Masked' checkbox), 'Source Port' (a text field with 'xxxxx' and a 'Masked' checkbox), 'Destination Addr.' (a text field with '229.30.21.22' and an 'Unmasked' checkbox), and 'Destination Port' (a text field with 'xxxxx' and a 'Masked' checkbox). At the bottom of the window are 'Cancel' and 'Save' buttons.

b. Move the Enable Audio slider to **Enabled** so the audio stream is subscribed from the media switch.

c. Select the number in SFP Port.

d. Enter the Source and Destination information for each audio stream.

Note: The SFP (physical) Port configuration is common for Video, Audio, and Data.

Note: The Source Addr, Source Port, and Destination Port are optional if the IP stream is uniquely specified.

e. Set the RTP Payload Type between 96 and 127.

Note: The RTP Payload Type is displayed in the IP Status application.

f. Set the number of channels in the audio stream between 2 and 16.

The number of channels must be an even number (2, 4, 6, etc.). A maximum of 16 audio channels, across all audio streams, are supported.

Note: The Bit Depth is already set to 24.

g. Select **Save**.

AUDIO SETTINGS	
RTP Payload Type	97
Num of Channels	16
Bit Depth	24

Cancel Save Stream 1

Select Audio Settings

1. Choose the type of audio. [Select PCM](#) or [Select DOLBY](#) (use of Dolby requires the MP2-DLBY license).

Stream 4 P1- Dst: 0.0.0.0 : 0 type: 97 CH: 16
ST2110-30 Mapped

PCM DOLBY

Program Configuration

Cancel Save

Select PCM

- a. Select **Program Configuration**.
- b. Move the Program Configuration slider to **On**.
- c. Select **Edit**.

The Edit button disappears and the Default, Clear, and Undo buttons replace it.

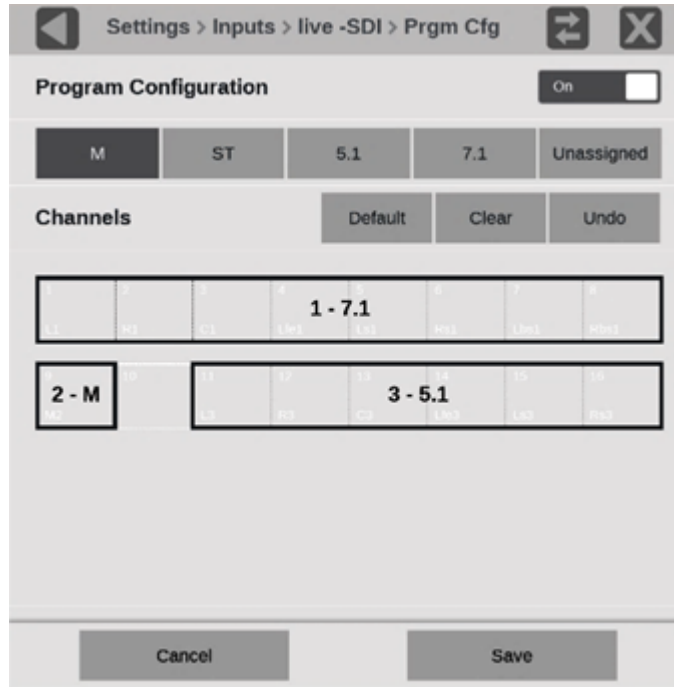

- d. Select the type of program (mono, stereo, etc.) and select the audio channel to assign it. Repeat until all the audio in the current input signal have programs assigned to channels.

M is mono, 1 channel.

ST is stereo, 2 channels.

5.1 is surround sound, 6 channels.

7.1 is surround sound, 8 channels.

Unassigned removes an assignment from a channel. Click **Unassigned** and click any block in an assignment, for example the middle of a 7.1 assignment, the entire assignment is removed and is not displayed on the Audio application.

Default resets the channels to 8 stereo pairs.

Clear removes all assignments, including the default.

- e. Select **Save** and close the menu.

Note: You must save the program configuration to update the programs in the audio bars and loudness meter.

Select DOLBY

Note: Dolby D Plus and E are available in SDI and 2022.

- a. Select **DOLBY**.
 - b. In the Dolby Audio Channel Pair menu, select the audio channel pair that contains Dolby audio.
Dolby audio in the selected channels are then decoded. Only Dolby D/D Plus/E decode is supported.
 - c. Select **Save** and close the menu.
-

Note: Audio programs configured in the Program Configuration menu are used to select a program for measurement by the Loudness application, to display audio bars in the Audio application, and to monitor with headphones. When all the channels are unassigned, all the channels are treated as stereo pairs. The audio programs in the Dolby E stream are automatically set up based on the Dolby E metadata.

Note: The number of audio streams and channels determines the content and order of audio channels embedded in the AUX OUT.

Note: If the audio bars are flashing in the audio display, or sounds are garbled or the wrong pitch, it is possible that the audio input configuration is not set up correctly. Check the IP address, port, and payload type from the IP session display and make sure to select the correct number of audio channels. A guideline for the number of audio channels (assuming 24bit 48khz audio) is approximately 1 to 1.5 Mb/s per channel. See the IP Status Bitrate column.

Note: To receive only audio, disable the video stream.

2. Configure the Data (2110-40) stream tab:
 - a. Select the **Data** tab.
 - b. Move the Enable Data slider to **Enabled** to begin configuration.

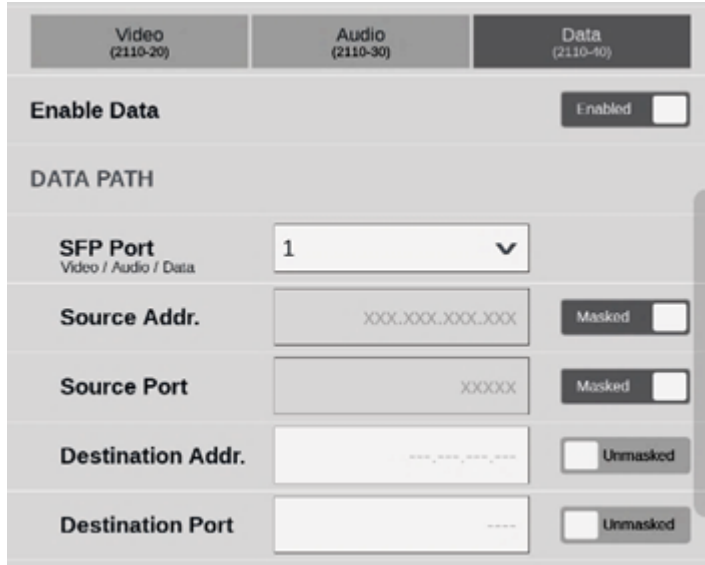

- c. Enter the information in SFP Port, Source Addr, Source Port, Destination Addr, and Destination Port for each data stream.
 - d. Set the RTP Payload Type between 96 and 127.

Note: The RTP Payload Type number must be unique for each IP stream. The RTP Payload Type is displayed in the IP Status application.

- e. Select **Save** and close the menu.
3. To begin monitoring this input, select the configured input. (See [Select Input.](#))

Configure RTP

Monitoring general purpose RTP streams allows you to see physical and IP layer measurements, but none of the video, audio, and data payload is decoded and displayed.

To monitor general purpose RTPstreams:

1. Select RTP.

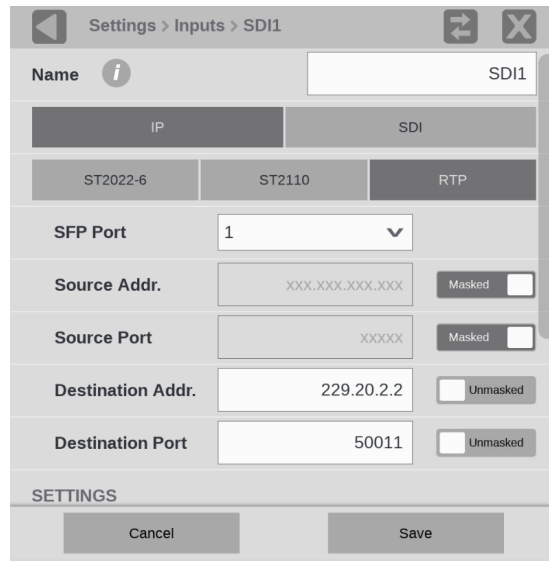

2. In SFP Port select the port being monitored.
3. Enter Source and Destination information.
4. Set the RTP Payload Type between 0 to 127.
5. Select the Video Format and corresponding Frame Rate.
6. Select **Save** and close the menu.
7. To begin monitoring this input, select the configured input. (See [Select Input.](#))

Select Input

To select a configured input:

1. Select the **Input** icon () from the Status bar at the bottom of the PRISM monitor.
2. Select a configured input from the list in the bottom bar.



3. Select the **Home** icon () to close the Input selection controls.

Configure Instrument for HDR/WCG Monitoring

PRISM provides HDR/WCG monitoring features that set up and balance cameras in HDR/WCG during content creation. Before using these features, configure the signal input (see [Configure and Select Signal Inputs](#)). Use the Gamma and Color Gamut drop-down menus to adjust the PRISM monitor settings to reflect the input signal properties if they are not automatically selected.

These applications and features are used to configure the instrument for HDR/WCG monitoring.

Waveform Display

In the Waveform display application, use the **Graticule** drop-down menu to select the graticule that fits your application. The trace represents the video data in the vertical axis. (See [Waveform Application](#).)

- The %, mV, and Code Value are fixed graticules. They are compatible with the traditional waveform scales.
- The Reflectance and Stop graticules vary depending on the Gamma selection in the Input Settings menu. These are the Scene light graticules that are used for scene setting and camera exposure adjustment.
- The Nits graticule varies depending on the Gamma selection in Input Settings menu. This is the Display light graticule and is used for mastering the content for a targeted HDR system.

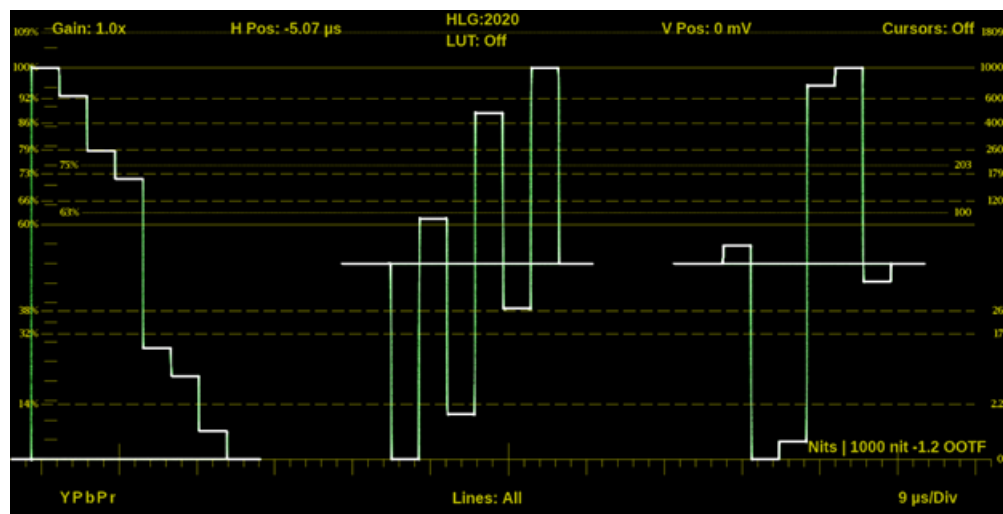

Stop Display (Option MP2-PROD only)

In the Stop Display Settings menu (select and hold in the application tile and select the **Settings** icon (⚙️)), in Reference select Display Light or Scene Light depending on your application. The trace represents light level in the vertical axis. (See [Stop Display Application](#).)

- Scene Light shows a stop graticule in the vertical axis and is fixed regardless of the selected Gamma. It is used for scene setting and camera exposure adjustment.
- Display Light show a Nits graticule in the vertical axis and is fixed regardless of Gamma selected. It is used for mastering the content for a targeted HDR system.

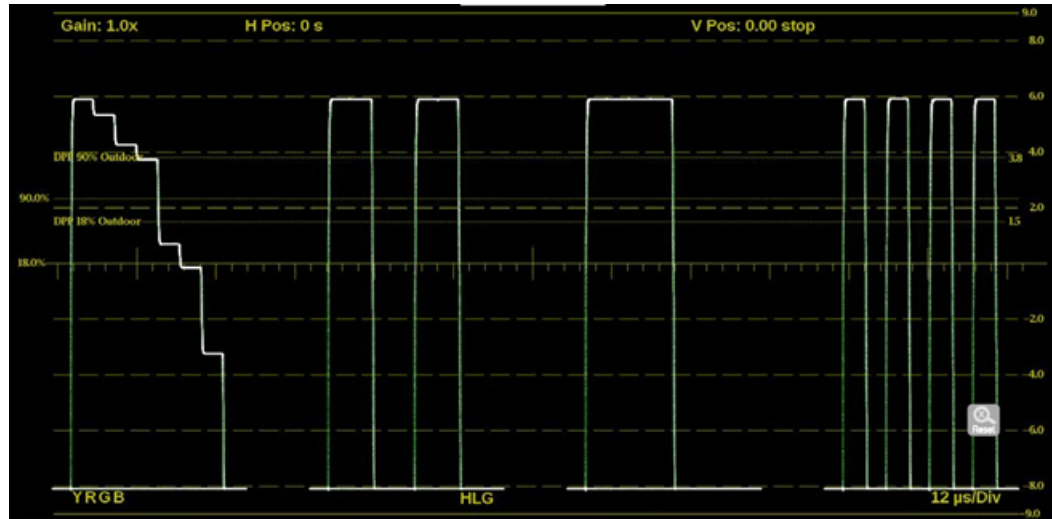

Transfer Function/Color Space Conversion (Option MP2-PROD only)

Transfer function/color space conversion is available in Waveform, Vector, Diamond, and Picture applications. Use the **Convert to Rec. 709** feature to convert the Gamma / Gamut settings for the signal to the BT. 709 Gamma / Gamut signal. This feature allows you to match the skin tone and the color in BT. 709 Gamma / Gamut displays. The conversion between input video and linear light is processed in Scene light.

Note: Convert to Rec. 709 mode is not supported for SD signals.

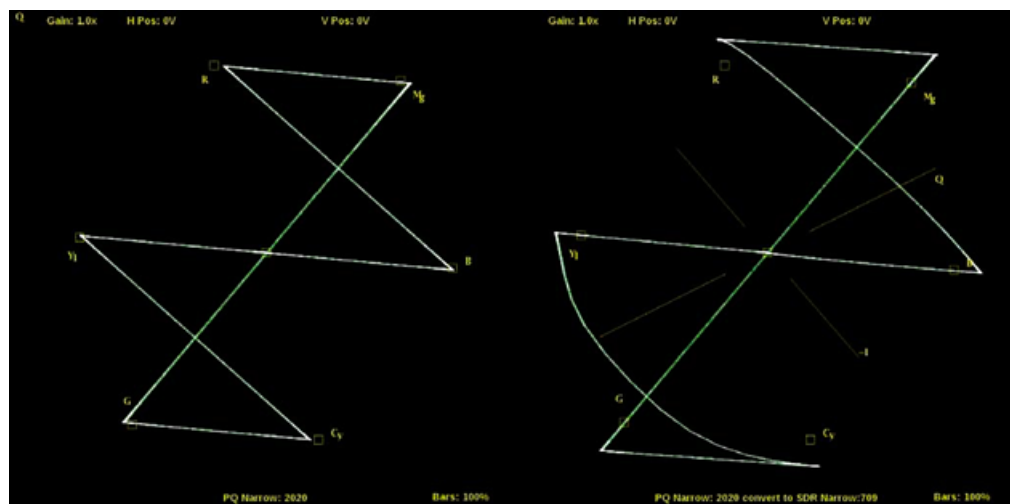

Enable NMOS Discovery and Registration

The NMOS/SDP and API allows system integrators to build an IP system with PRISM being managed by system management software. The software discovers, registers, configures inputs, and selects the active input for monitoring.

To enable NMOS on your instrument:

1. Select the **Settings** icon () to open the Settings menu.
2. Select **Network** to open the Network submenu.
3. Slide the Enable NMOS Discovery & Registration control to Enabled or Disabled.
4. Close the Network menu.

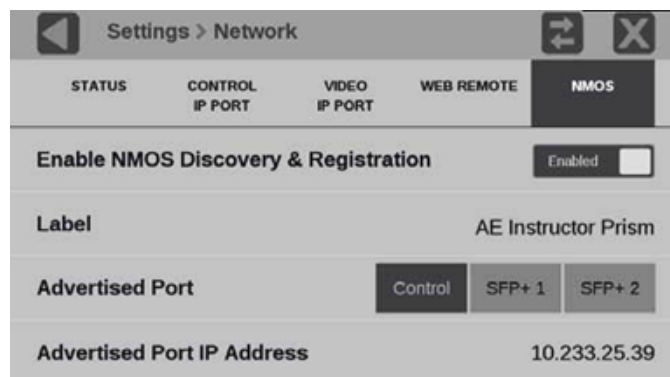

Note: The Advertised Port is the physical port on the back of the instrument. The Control selection is for the RJ-45 10/100/1000Mbps Ethernet port.

Note: When changes are made to the control port IP address or the label of the instrument and NMOS is being used for configuration, we recommend rebooting the instrument to update the NMOS registration server.

Adjust Loudness Display

The Loudness Display is a part of the Audio App in PRISM and is configured in the Settings menu. The Loudness Display allows you to view audio loudness values associated with audio loudness measurements. This instrument maintains a running audio loudness session.

Turn on the Loudness Display

1. Open the Audio app.
2. In the application toolbar, select the **Tile** icon () to open the Audio Settings menu.
3. Set Loudness Display to **On**.

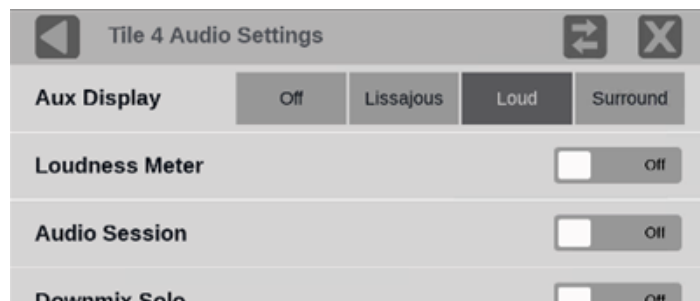

The Loudness Display appears in the right half of the tile.

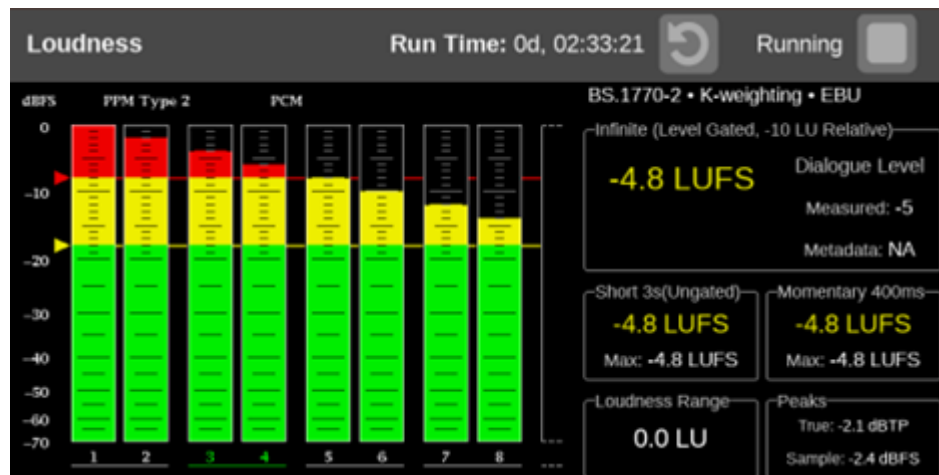

Note: The view varies based on the visibility selection of other auxiliary audio displays including Audio Session or Lissajous Display.

Configure the Loudness Display

1. Select the **Settings** icon () from the status bar.
2. Select **Audio** to open the Audio submenu.
3. Select **Loudness Settings**.

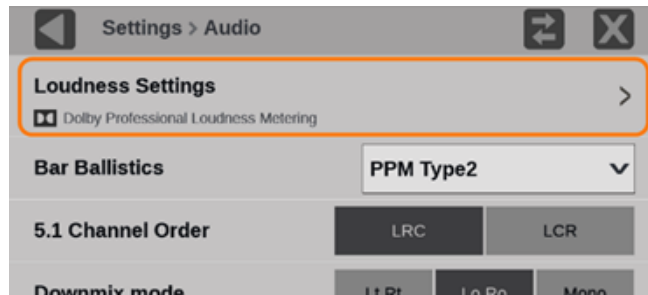

4. Load a standard preset: Select EBU R128:2014 or ATSC A/85:2014 for a pre-defined set of loudness metering configuration.

Or customize the Loudness Display configuration according to the metering measurement goal or audio content type (dialogue, music, or movie). The next table shows the available configuration parameters.

Configuration Parameters for Loudness Display

Parameter	Available Configurations	Remarks
LOUDNESS METERING MODE	BS.1770-1 with DI ¹ , BS-1770-2 with DI, Leq(A) with DI, BS.1770-2 w/o DI	Modes implies a weighting function (A-weighting or K-weighting) and gating technique(s) when performing loudness metering
Speech Threshold (%)	0 to 100%	Threshold above which the Speech Gating is turned on in the DI enabled Metering modes
Loudness Ballistics	Short Average, Long Average, EBU R128 M	Sets the response of the Loudness meter bar
TARGET LOUDNESS	0 to -31LKFS with 0 to 10LU tolerance	Sets the intended target loudness (to be highlighted in the Loudness display with appropriate color code)
LOUDNESS THRESHOLDS	Loud is 0 to -30 and Quiet 0 to -60 Full Scale Loudness	Sets the limits to trigger in-bar status for quiet and loud level

Configuration Parameters for Loudness Display

Short-Term Gating Window	EBU R128(3s), Legacy(10s)	Duration of the sliding windows for short-term loudness measurement
Full-Scale Units	LKFS or LUFS	Region specific selection; has no effect on measurement
TRUE PEAK DC Block and Emphasis Filter	Enable or Disable	DC block simulates the effect of downstream devices that remove DC. The emphasis filter compensates for dispersion effects from Nyquist filters in the broadcast chain that make it difficult to measure and control the peak levels of high-frequency signals.

¹ Dialogue Intelligence enabled

Note: The dialogue intelligence algorithm in PRISM introduces a latency of 2.048s in the effective measurement of the short-term and infinite Loudness. Other Loudness measurement parameters are not affected by the latency.

Note: The Loudness measurements are updated every 500ms in the user interface.

Note: Maximum short-term Loudness level can be considered as an alternative to using Loudness range for short audio clips.

Change the Channels the Loudness Meter Measures

Select the correct program labels at the bottom of the level bars (green letters mean it is selected) and the Loudness meter measures the levels based on that audio program.

Note: Changing the selected Audio program that the Loudness meter measures changes the headphones or speaker pair, and changing the headphones or speaker

pair changes the selected Audio program the Loudness meter measures. Changing the Audio program also resets the Loudness measurement.

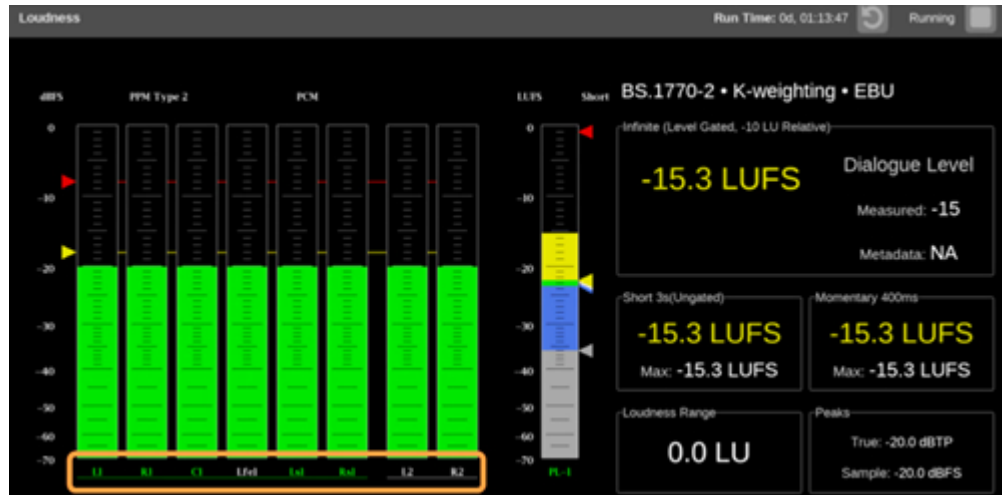

Note: The low-frequency effects channel (Lfe1) in 5.1 and 7.1 is not used in the loudness calculations.

Loudness Meter Labels

- The labels at the bottom of the audio bars (marked as 1) in this example means it is program 2 and there is a left and a right channel.
- The label at the bottom of the Loudness bar (marked as 2) means it is measuring program 2.
- The green letters in the status bar (marked as 3) mark the channels the Loudness display is measuring and where they are in the channel series.

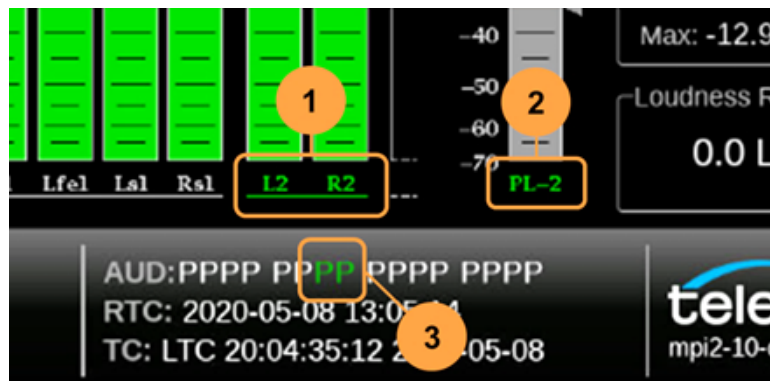

Meter Controls

- To start and stop the loudness meter: select the play (▶) or stop (◻) button.

- To reset the measurement run time: select the reset button (↺).

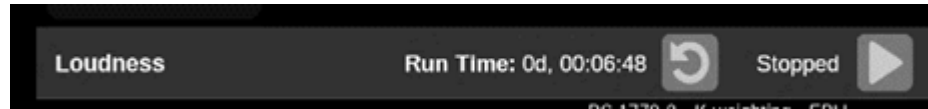

- The Audio Session and Loudness measurements can be independently stopped, started, and reset with the controls.



Configure Downmix Mode

With the downmix parameters set, select one of the Downmix Mode options in the Settings Audio menu:

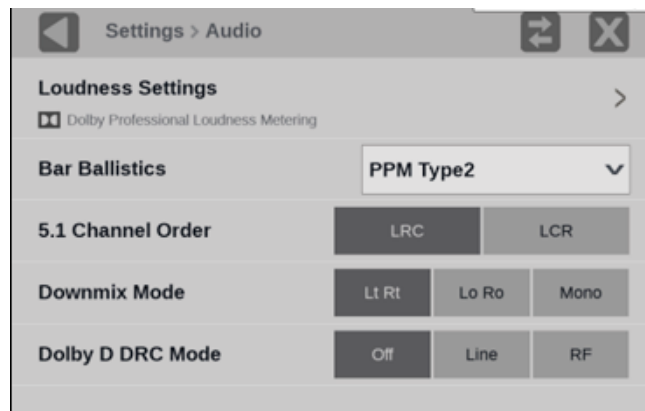

- **Lt Rt:** Reduces the stream to 2 channels. The center channel is reduced 3dB, the surround channels are added together to create a single signal and reduced 6dB, and the LFE is muted. The surround signal is added 180 degrees out of phase to the left-and-center signal, making up the left-total channel. The surround signal is added *in* phase (0 degrees) to the right-and-center signal, making up the right-total channel.
- **Lo Ro:** Reduces the stream to 2 channels. The center channel is reduced 3dB, both surround channels are reduced 3dB, and LFE is muted. The center channel is added to the left-and-left-surround signal to make the left-only channel. The center channel is added to the right-and-right-surround signal to make the right-only channel.
- **Mono:** Reduces the stream to one channel. The center channel is reduced 3dB, the surround channels are each reduced 3dB, and the LFE is muted. All 6 channels are combined.

Configure Dolby D DRC Mode

Select Off, Line, or RF.

Line and RF are modes of Dynamic Range Control (DRC)—compression—factors that are applied when decoding Dolby content for monitoring or output.

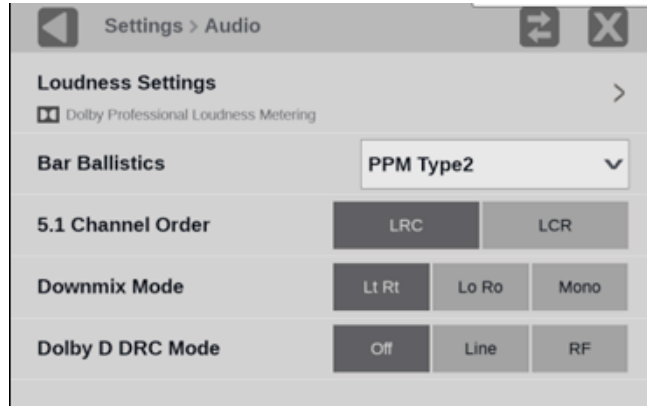

Select Downmix Dynamic Rng. Select Line or RF. These DRC compression factors are applied when downmixing to the various Dolby D listening modes.

Configure Instrument Outputs

PRISM allows you to set the SDI OUT connector to Loop-through or Generator.

To change the SDI output

1. Select the **Settings** icon () to open the Settings menu.
2. Select **Outputs** to open the Outputs submenu.
3. Set the SDI output to Loop-through or Generator.



4. Close the Outputs menu.

SDI OUTPUT loop-through of IP inputs is available for SDI, ST2022-6, and ST2110-20/30 (see [Configure the Audio \(2110-30\) stream tab](#): for audio configuration details) including embedded audio streams.

See the SDI Generator applications for instructions on how to configure the SDI Generator signal.

Configure to Decode Timecode

Timecode decodes and displays ST 12-1:2014 Ancillary Timecode on the Status bar. ANC LTC (linear time code), ANC VITC (vertical interval time code), and Date Readout are supported.

1. Select the **Settings** icon () to open the Settings menu.
2. Select **Anc Data** to open the Anc Data submenu.
3. In Timecode Format select LTC or VITC as needed and close the menu.

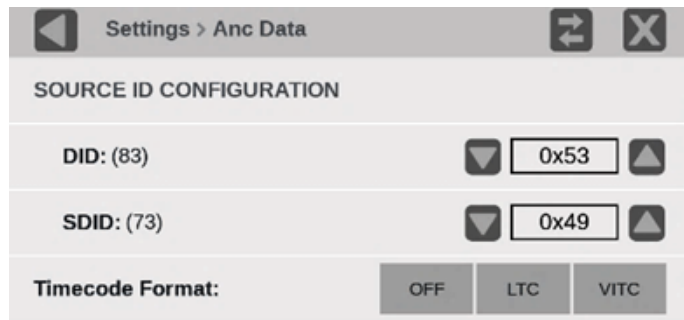

The selected timecode appears in the bottom border of the Status frame and all alarms and events.



Configure Reference Settings

The reference configuration of the PRISM is displayed in the middle of the status bar. The third line is the reference type and the fourth line displays the Video versus Reference lock indication. This indication shows if the signal is N/A, Mismatched, Drifting, or Locked.

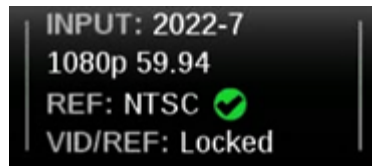

Choose the Reference

The Timing application supports SDI timing against Analog external reference, Analog external reference timing against PTP, SDI timing against PTP, and IP timing against PTP.

To choose the external reference

1. Select the **Settings** icon () to open the Settings menu.
2. Select **Reference** to open the Reference submenu.



3. Select one of the reference options:
 - Internal: The timing is based on an internal clock.
 - Analog: Refers to a Black Burst (BB) or Tri-Level Sync (TLS) external reference. An analog external reference is connected to the REF BNC input on the back panel.
 - PTP: Refers to Precision Timing Protocol (PTP) external reference. PTP external reference must come through the 10/25GE SFP Port 1 input on the back panel.

Note: When a reference selection is made the reference changes in the status bar and in the Timing application.

Configure the Analog Reference Settings

1. Select the **Settings** icon () to open the Settings menu.

2. Select **Reference** to open the Reference submenu and select the **Analog Ref Setting** submenu.



3. Select from one of these reference I/O options:
 - **Loop-Through:** The REF input is looped out the REF output BNC.
 - **Terminate Input:** The REF input is terminated at the REF input BNC. There is no signal at REF output BNC.

Configure the PTP Reference Settings

1. Select the **Settings** icon (⚙️) to open the Settings menu.
2. Select **Reference** to open the Reference submenu and select the **PTP Settings** submenu.

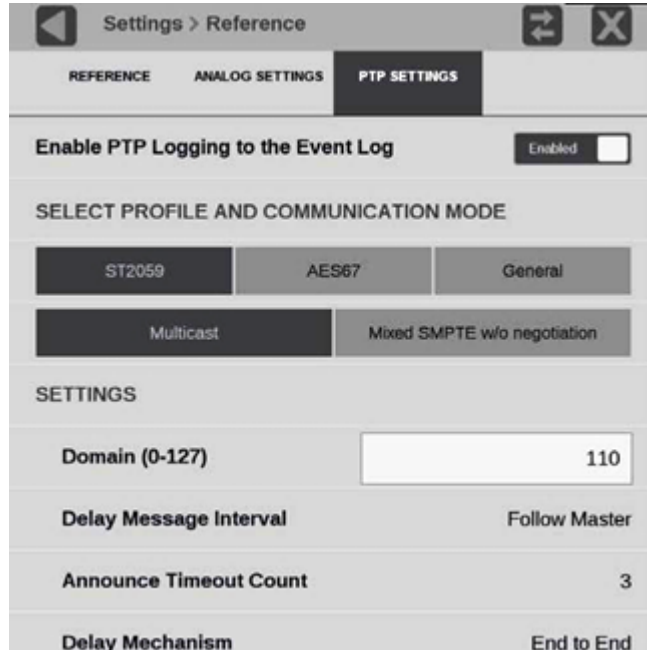

3. To enable or disable PTP logging to the Event Log, select the control box to change the setting to the state.
4. Select the profile to configure: ST2059, AES67, or General. The default communication mode for each profile is Multicast.

5. If you select the ST2059 profile and the communication mode, it is a mixture of Multicast and Unicast, select **Mixed SMPTE w/o negotiation**.

Note: On the SMPTE profile mixed mode, the PTP Announce and Sync messages are sent as Multicast. However, the Delay request and Delay Response messages are sent as Unicast.

6. Select the **Domain (0-127)** box to open the editing display.

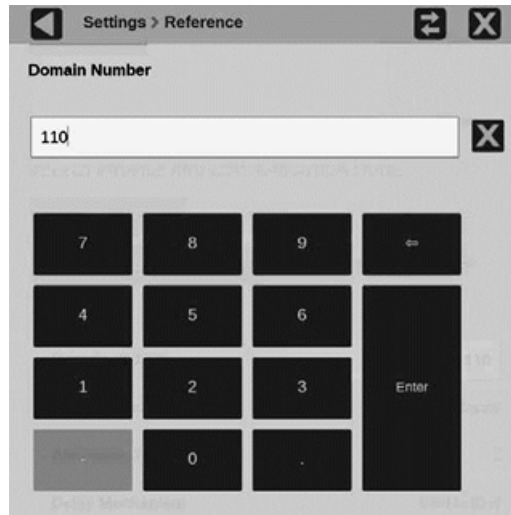

7. Use the editing controls to enter a new domain number. When using the editor:
 - Select the Clear icon (X) to remove the existing domain number.
 - Select the **backspace** key to delete characters by backspacing over them.
8. When you are done editing the domain number, select the **Enter** key.
9. Repeat steps 4 to 6 for each PTP profile.

Set and Recall Instrument Presets

Instrument setups can become complex as you tailor them to monitor various parameters. To save set up time and ensure consistency, you can save and quickly access instrument setups in your instrument using the **Presets** icon () on the instrument display.

Note: For the MPX monitor, you can recall instrument presets from the front panel. (See [Recall Instrument Presets.](#))

The instrument can store up to 36 separate instrument presets. The presets are divided into six groups, A through F, with each group containing 6 preset storage locations. The default preset names are A1-A6, B1-B6, C1-C6, D1-D6, E1-E6, and F1-F6.

All instrument settings except those set in the Utilities and Network Settings submenus of the Configuration menu are saved in a Preset. Settings that are not saved are those such as the clock setting, IP configuration, and network address. This is an overview of the settings saved in a Preset. Some settings are option dependent.

- Application assigned to each tile
- Application icon order in the application selector list
- Application specific settings
- Input selection and configuration
- PTP reference settings
- SDI Generator and IP Generator settings

Turn on Edit Mode

When Edit mode is on, selecting a preset button displays a menu to allow changes to that preset button (Rename and Save as) you can also recall the existing settings (Recall).

When edit mode is off, selecting a preset button only recalls the preset settings assigned to that button, with no confirmation.



When Edit mode is on, you can assign any preset button with any configuration of applications, outputs, and inputs.

1. Select the **Settings** icon (⚙️) to open the Settings menu.
2. Select **Presets** to open the Presets submenu.
3. Set Edit Mode to **On**.

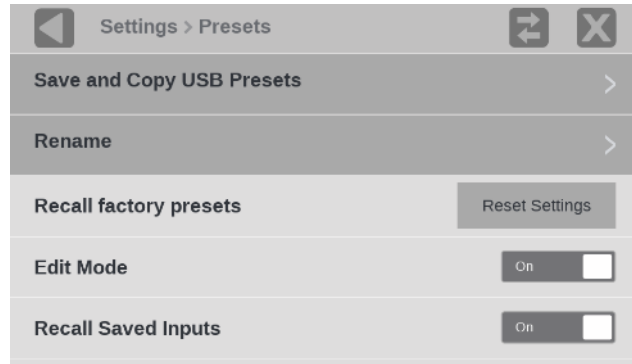

Save Presets

To save a preset with a user-defined name and settings, or to reassign a named preset with new name and settings:

1. Set up the instrument exactly as you want it configured. This includes selecting the application display for each tile and configuring inputs and the PTP reference settings.
2. *Turn on Edit Mode.*
3. Select the **Presets** icon (★) to open the Preset selection menu at the bottom of the PRISM display.

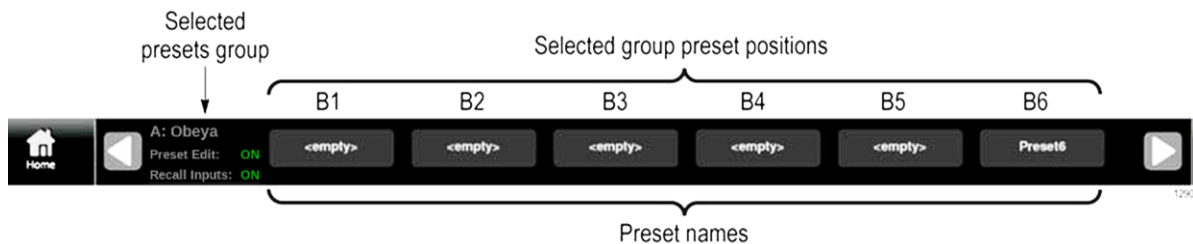

4. Locate the Preset button you want to save with the current instrument configuration. There are 6 presets in each of 6 groups. Use the arrow buttons (◀ and ▶) or swipe left or right to move to the preset group (A–F).

Note: When a preset has no content, <empty> is displayed on the preset button.

5. When you have found the preset to assign the settings (this includes choosing an assigned preset and overwriting the existing settings), select the preset button.

A menu displays.



6. Select **Save As** to save the existing settings to the highlighted preset button and name it.

An on-screen keyboard appears.

7. If the preset button name is <empty> or you want to change the name, use the keyboard. If you do not want to change the name, select **Save**.

A confirmation window displays.

8. Select **OK** to save the preset.

The preset name changes from <empty> or a name to the entered name. The number is the preset position in the preset group.

9. Select the **Home** icon () to close the Preset selection menu.

Rename PRISM Presets

To rename a preset without changing any settings.

1. *Turn on Edit Mode.*
2. Select the preset to rename.
3. Select **Rename** and use the keyboard to enter a new name.
If Rename does not appear, Edit mode is not on.
4. Select **Save**.

Rename Group of Presets

1. Select the **Settings** icon () to open the Settings menu.
2. Select **Presets** to open the Presets submenu.

3. Select **Rename** to open the Presets Rename submenu.

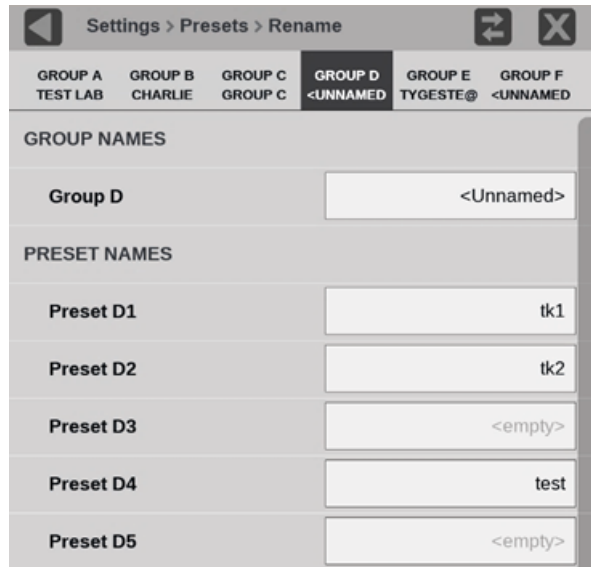

4. Select the Preset group, at the top of the submenu, to select the group with the preset to rename (this includes naming an <empty> preset).

5. Select the name box of the preset you want to name or rename.

An on-screen keyboard displays.

Note: You can also rename a preset group by selecting a group name box.

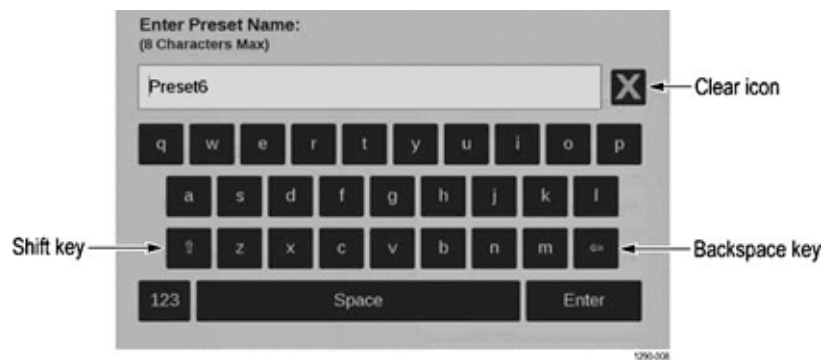

6. Use the on-screen keyboard to enter a new name for the preset. When renaming a preset:
 - Enter a name with a maximum of 8 characters.
 - Select the Clear icon (ⓧ) to remove the existing name.
 - Select the Shift key to access capital letters.
 - Select the Backspace key to delete characters by backspacing over them.
 - Select the 123-abc key to change between the letter keyboard and the numbers-symbols keyboard.
7. When the preset name is correct, select **Enter**.

Note: If the Edit Mode is on, you can rename a preset through the Preset selections menu. Select the preset to rename and then select **Rename**, and rename the preset just as in the Presets Rename submenu.

Download and Upload PRISM Presets

To download the presets of an entire PRISM (clone the presets) and upload them to another PRISM, there are two methods: [Download the Presets to a USB Memory Drive](#) or [Download a File of Presets Locally](#).

Download the Presets to a USB Memory Drive

1. Insert a USB drive into the PRISM with the presets.
2. Select the **Settings** icon (⚙️) to open the Settings menu.
3. Select **Presets** to open the Presets submenu.
4. Select **Save and Copy USB Presets** and then select **SAVE TO USB**.
5. Select the USB drive and select **Save**.

A copy of the presets is downloaded to the USB drive.

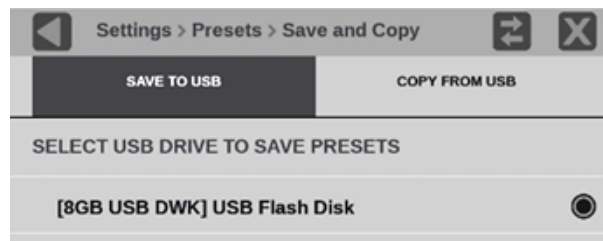

6. Select the Activity icon (🔔) and then select the **Eject** icon (⏏) to unmount the USB drive from the instrument.
7. Remove the USB drive with the presets from the PRISM.
8. To upload the presets to another PRISM, go to [Upload the Presets from a USB Memory Drive](#).

Upload the Presets from a USB Memory Drive



Caution: This overwrites all existing presets in the PRISM.

1. Insert a USB drive with PRISM presets into the PRISM to upload the presets.
2. Select the **Settings** icon (⚙️) to open the Settings menu.
3. Select **Presets** to open the Presets submenu.
4. Select **Save and Copy USB Presets** and then select **COPY FROM USB**.
5. Select the USB memory drive and select **Copy**.

The downloaded presets are uploaded to the PRISM.

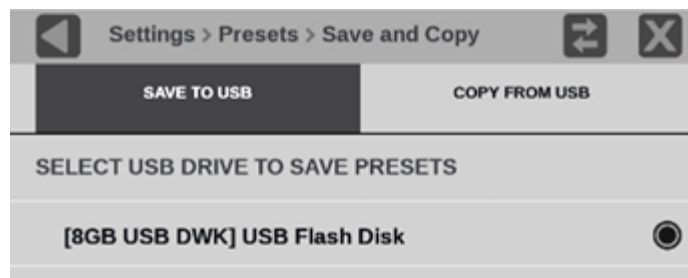

6. Select the Activity icon (🔔) and then select the **Eject** icon (🗑️) to unmount the USB drive from the instrument.
7. Remove the USB drive with the presets from the PRISM.
8. Select the Close icon (✕) to close the Save and Copy USB Presets submenu.
9. Repeat steps 1 to 9 for any other PRISMs to copy the presets.

Download a File of Presets Locally



Caution: This overwrites all existing presets in the PRISM.

1. Go to the PRISM HOME page for the PRISM with the presets.
2. Select **Preset Download and Upload**.

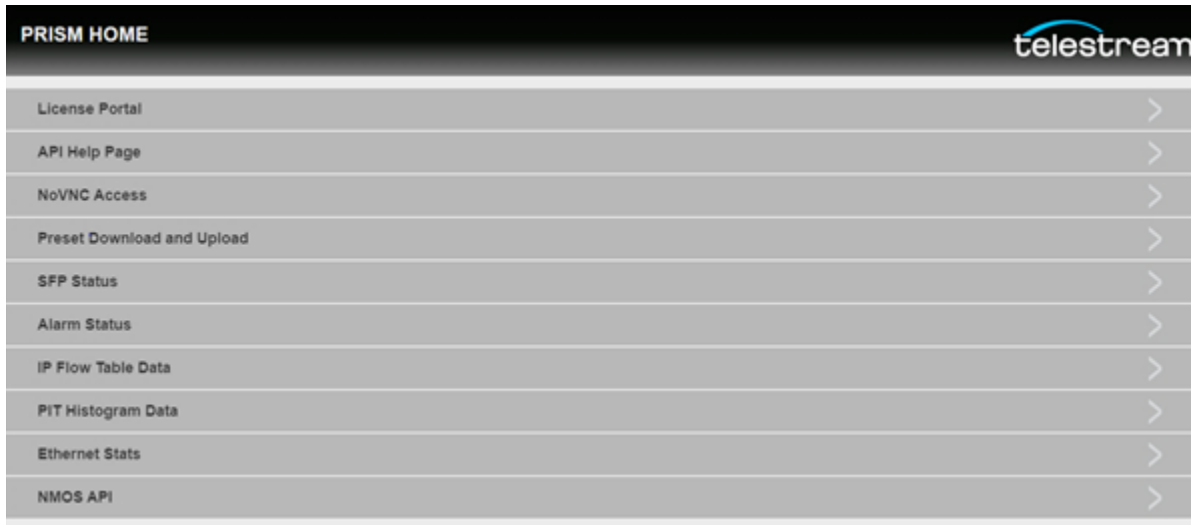

3. Select Download from PRISM and then select Download.

A copy of the presets is downloaded to your local computer with the name of the PRISM and a timestamp, or you can rename the presets file.

4. To upload the presets to another PRISM, go to [Upload the Presets through the PRISM Homepage](#).

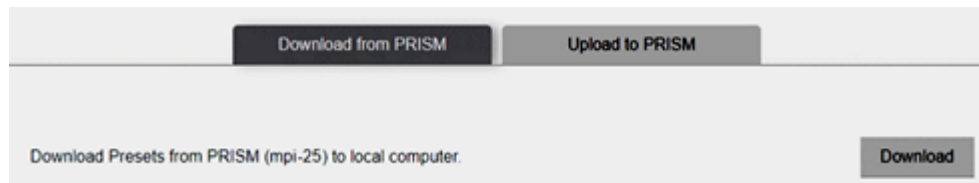

Upload the Presets through the PRISM Homepage



Caution: This overwrites all existing presets in the PRISM uploading the presets.

1. With the presets file downloaded locally, go to the PRISM HOME page for the PRISM to upload the presets.

2. Select Preset Download and Upload.

3. Select Upload to PRISM and then select Browse.

A file explorer window displays.





4. Find the saved preset (.prst) file, select it, and select **Open**.
The file explorer window closes and the preset file is listed on the PRISM HOME page.
5. Select **Upload**.
The downloaded presets are uploaded to the PRISM.
6. Repeat steps 1 through 5 for any other PRISMs to receive the same presets.
7. Select the browser back button to return to the PRISM HOME page.

Recall User-Defined Presets

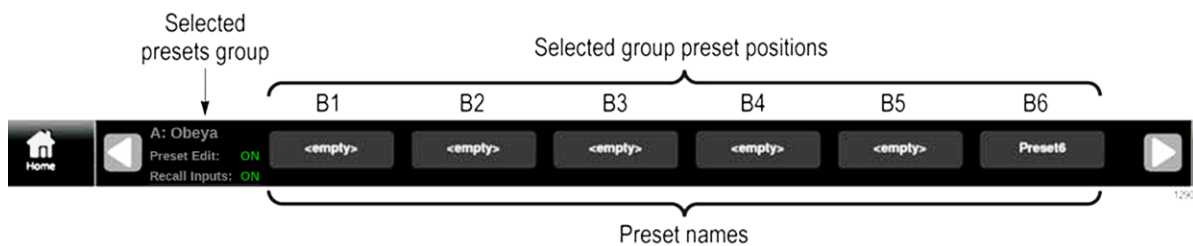
1. Select the **Presets** icon () to open the Preset selection menu.



2. Find the preset to recall. Use the arrow buttons ( and ) or swipe left or right to move to the preset group (A–F).

Note: When a preset has no content, <empty> is displayed on the preset button.

3. Select the preset button to recall.
The selected preset button is highlighted and the instrument settings change to those assigned to the selected preset.
4. Select the **Home** icon () to close the Preset selection menu.

Note: If the Edit Mode is on, select the preset to recall and then select **Recall** from the menu.

Recall Presets without Inputs

Presets contain all PRISM settings including input configuration. Turning off the Recall Saved Inputs setting allows the presets to be recalled without recalling any of the input settings (video, audio, data). In this mode only the application and other settings are recalled.

Note: The preset still has all of the input settings, they are just not applied when the Recalled Saved Inputs setting is off.

1. Select the **Settings** icon () to open the Settings menu.
2. Select **Presets** to open the Presets submenu.

3. Set the Recall Saved Inputs to **Off**.

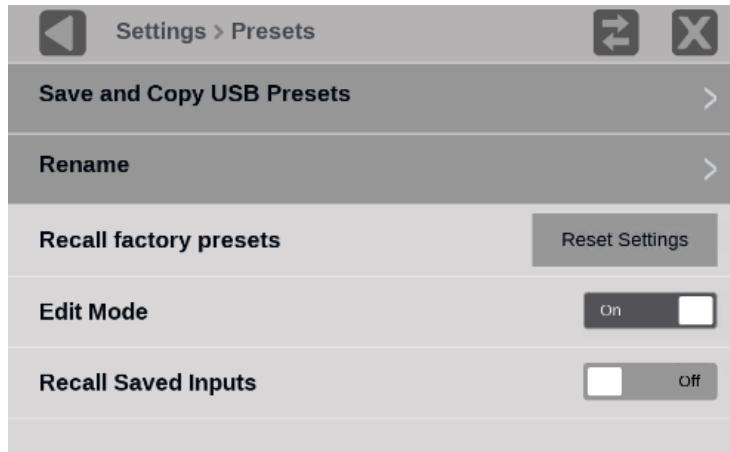

Recall Factory Presets

1. Select the **Settings** icon () to open the Settings menu.
2. Select **Presets** to open the Presets submenu.
3. Select **Recall Factory Preset**.

A confirmation box displays.

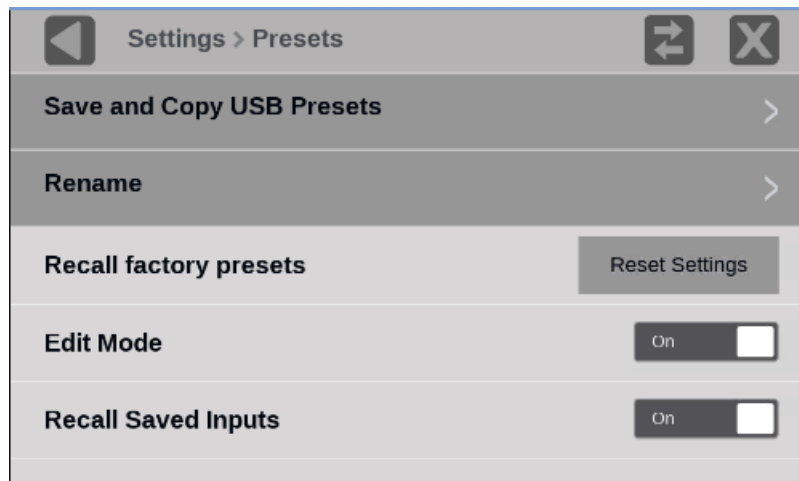

4. Select **OK** to confirm the selection and to reset the instrument settings to the factory defaults. The next table lists some of the settings that are reset.

Note: Custom presets are still available after recalling the factory preset.

Instrument settings reset by Recall Factory Preset

Item	Setting
Tile 1 application	Waveform
Tile 2 application	Video Session
Tile 3 application	Picture
Tile 4 application	Audio
SDI-In 1 input configuration	
Input name	SDI-In 1
Input type	SDI
Input connector	SDI 1
SDI-In 2 input configuration	
Input name	SDI-In 2
Input type	SDI
Input connector	SDI 2
SDI-In 3 input configuration	
Input name	SDI-In 3
Input type	SDI
Input connector	SDI 3
SDI-In 4 input configuration	
Input name	SDI-In 4
Input type	SDI
Input connector	SDI 4
SDI-SFP 1 input configuration	
Input name	SDI-SFP 1
Input type	SDI
Input connector	None selected
SDI-SFP 2 input configuration	
Input name	SDI-SFP 2
Input type	SDI
Input connector	None selected

Instrument settings reset by Recall Factory Preset

Item	Setting
PTP reference configuration	
PTP Logging to the Event Log	Enabled
Selected Profile	ST2059
ST2059 domain	127
ST2059 communication mode	Multicast
SDI Generator configuration	
Enable SDI Generator	Disabled
IP Generator configuration	
Enable IP ST2110 Generator	Disabled
Reference	Internal

Alarms

Alarms are always operational and logged (with a few exceptions). They are also optionally sent to a syslog server or SNMP client. For each alarm group or individual alarm, you can also enable presentation on the Activity Dashboard.

Many alarms also have user-definable thresholds to set specific limits for the alarm.

Configure Alarms

Open the Alarms

Select **Settings**, and then select **Alarms**.

- To turn on the group of alarms, select the checkbox under Dashboard for the group.

- To reset the thresholds for a group of alarms, select the reset icon (🔄) under Threshold for the group.

	Threshold	Dashboard
ANC Session		<input checked="" type="checkbox"/>
Audio		<input type="checkbox"/>
CC / Subtitles		<input checked="" type="checkbox"/>
Gamut		<input type="checkbox"/>
IP		<input type="checkbox"/>
Timing		<input checked="" type="checkbox"/>
Video Session		<input checked="" type="checkbox"/>

Select a Specific Alarm

- Select the alarm group that contains the specific alarm.
- Select the UI checkbox of the alarm to monitor.

Alarm	Threshold	Dashboard
Audio Over Error	>0 dB for >1 s	<input checked="" type="checkbox"/>
Audio Pair Out of Phase	<-30% for >1 s	<input type="checkbox"/>
Audio Signal Lost	N/A	<input type="checkbox"/>

Note: If the alarm shows information in the Threshold column (not N/A), you can change the setting.

Change an Alarm Threshold

- Select the alarm title.
The Thresholds option displays.

2. Select the arrows to change the threshold settings.

Depending on the alarm, there could be from one up to four thresholds.

Alarm	Thresholds	UI
Audio Signal Lost	N/A	<input checked="" type="checkbox"/>
Audio Over error	>-3 dB for >10 s	<input checked="" type="checkbox"/>
Duration	<input type="text" value="10"/> s	
Max	<input type="text" value="-3"/> dB	
Audio Pair Out Of Phase	<-30% for >4 s	<input checked="" type="checkbox"/>

Group alarm titles (bold), related alarms, and the related-alarms descriptions

ANC Session

SCTE104 Message Received: An SCTE104 packet has been received as seen on the ANC Session application.

Audio

- Audio Over Error: Signal is at or above the specified Over level for a time longer than the duration setting.
 - Audio Pair Out of Phase: Currently selected channels displayed in Lissajous have the channel correlation at or below the specified percentage for a time longer than the duration setting.
 - Audio Signal Lost: No Audio is present in the currently active signal.
-

CC (Closed Captions) / Subtitles

- CEA708 Closed Captions Lost: No valid CEA708 closed caption packets in the ancillary data space were found.
- OP-47 Multipacket Teletext Lost: No valid Operational Practice 47 multi data packets were found in the ancillary data space of the signal.
- OP-47 SDP Teletext Lost: No valid Operational Practice 47 SDP data packets were found in the ancillary data space of the signal.
- S334-1 CEA 608 Closed Captions Lost: No valid S334-1 CEA 608 closed caption packets were found in the ancillary data space.
- S334-2 CEA 608 Closed Captions Lost: No valid S334-2 CEA 608 closed caption packets were found in the ancillary data space.
- SMPTE 2031 Teletext Lost: No valid SMPTE 2031 ANC data packets were found in the ancillary data space.

Group alarm titles (bold), related alarms, and the related-alarms descriptions

Gamut

YRGB Gamut: Indicates when the input signal contains colors that violate the currently set limits for YRGB gamut, which are specified by the Settings/Alarms/Gamut. These measurements conform to the EBU R103 standard.

Gamut measurements are supported for SD, 720p, 1080p slow frame rate, 1080i, and 1080p level A 422-10bit and 444-12bit.

Gamut measurements can be totally disabled to minimize CPU loading to enable quieter operation. To disable the Gamut measurements, set Gamut Enable to **Off**.

Note: When Gamut is disabled, no Gamut alarms are generated or logged.

Note: The Gamut Preset button, EBU R103, only resets the YRGB numbers, not the picture area or frame duration.

IP

- Combined RTP Sequence Error: RTP sequence error occurred in the combined output of a media stream protected using RTP packet reordering or S2022.7 seamless switching.
- Data Rate Invalid or Unstable: Detected data rate of a video input is unstable or nonstandard.
- Ethernet BER Excessive: Excessive bit-error rate has been detected on Ethernet interface.
- Ethernet Buffer Overflow: Overflow was detected on IP Video Ports.
- Ethernet CRC Error: CRC error was detected in an Ethernet frame.
- Ethernet Interface Saturated: Ethernet interface is saturated.
- HBRMT Header Invalid: Error occurred in the HBRMT header.
- HBRMT Sequence Error: Packets are dropped, out of order, or duplicated; or a sequence number in a flow does not change.
- HBRMT Timestamp Error: HBRMT timestamp is corrupt or is not updating at the correct frequency for the specified media type.
- L4 Protocol Checksum Error: Checksum error was detected in an IP or UDP packet.
- Network Connection Lost: Fiber connection to SFP port has been removed or FEC mode is in the wrong state.
- RTP Header Invalid: Error occurred in the RTP header.
- RTP Marker Frequency Error: RTP marker bit is not designated at the correct frequency for the specified media type.
- RTP Sequence Error: Sequence errors can be caused by dropped, out of order, or duplicated packets. They can also be triggered when the sequence number within a flow does not change.
- RTP Timestamp Error: RTP timestamp is corrupt or is not updating at the correct frequency for the specified media type.
- S2022/7 Path Missing: One of the datapaths in a S2022.7 seamless switching configuration is missing.

Group alarm titles (bold), related alarms, and the related-alarms descriptions

Timing

- **External Reference Lost:** External reference signal is not detected.
 - **Link Timing Error:** Timing difference between any two links exceeds 400 nanoseconds, according to ST425-6 2014.
 - **PTP Unlocked:** PTP is unlocked or missing.
 - **Timing Drift:** Input signal is not frequency locked to the reference signal. Drift rate is >10us of timing change on a 20-second window, larger drift rates are detected faster.
 - **Video and Reference Mismatch:** Detected format of the external reference signal is not compatible with the input signal format.
-

Video Session

- **Format Unsupported:** Detected video format is not supported.
- **Inter-link Format Mismatch:** Four links of a quad-link signal are not the same format.
- **SD Video Detected:** Detected video format is standard definition, for example 525 or 625.
- **SDI Active Field Length Error:** Input signal is not frequency locked to the reference signal.
- **SDI C-channel ANC Checksum Error:** Displays the status of the C channel ancillary embedded checksum value that was calculated for the video signal. Using a known test signal, the checksum status can be used to verify integrity through a system. An error means that the C Channel embedded checksum value does not match the calculated checksum value, which indicates that a transmission error has occurred.
- **SDI C-channel CRC Error:** Displays the status of the C channel embedded CRC (Cyclical Redundancy Check) that was calculated for the video signal. Using a known test signal, the CRC status can be used to verify integrity through a system. An error means that the C Channel embedded CRC value does not match the calculated CRC value, which indicates that a transmission error has occurred.
- **SDI EAV Placement Error:** SDI End-of-Active Video placement error has occurred.
- **SDI EDH Active Picture CRC Error:** RP165 AP CRC value embedded in the data stream differs from the calculated CRC, or that it has been marked as invalid in the EDH packet, indicating there are EDH errors in the active picture.
- **SDI EDH Full-Field CRC Error:** RP165 FF CRC embedded value differs from the calculated CRC value (or that it has been marked as invalid in the EDH packet), indicating that there are EDH errors in the full field.
- **SDI Line Length Error:** Incorrect encoded transport line number was detected.
- **SDI Line Number Error:** Incorrect encoded transport line number was detected.
- **SDI SAV Placement Error:** SDI Start-of-Active Video placement error has occurred.
- **SDI Total Field Length Error:** The total field length of SDI video is incorrect.
- **SDI Y-channel ANC Checksum Error:** Displays the status of the Y channel ancillary embedded checksum value that was calculated for the video signal. Using a known test signal, the checksum status can be used to verify integrity through a system. An error means that the Y Channel embedded checksum value does not match the calculated checksum value, which indicates that a transmission error has occurred.

Group alarm titles (bold), related alarms, and the related-alarms descriptions

Video Session (Continued)

- **SDI Y-channel CRC Error:** Displays the status of the Y channel embedded CRC (Cyclical Redundancy Check) that was calculated for the video signal. Using a known test signal, the CRC status can be used to verify integrity through a system. An error means that the Y Channel embedded CRC value does not match the calculated CRC value, which indicates that a transmission error has occurred.
 - **SMPTE 352M Payload ID Missing:** A mandatory SMPTE352M video payload identifier packet is missing.
 - **Video Format Changed:** TRS count performed by the instrument does not agree with the line number embedded in the 292M line.
 - **Video Format Mismatch:** Detected format of the video-input signal does not match the Input Format setting (which is set to a specific line rate, rather than being set to Auto) in the SDI Input submenu of the Configure menu or the setting specified in the SMPTE352 payload (if present).
 - **Video Signal Lost:** Video input signal has not been detected at the selected input.
-

Manage Trace and Graticule Intensity

The brightness of an applications graticule and trace can be adjusted with the intensity sliders in the Display settings menu.

To adjust graticule and trace intensity:

1. Select the **Settings** icon (⚙️) to open the Settings menu.
2. Select **Display** to open the Display submenu.
3. Use the plus icon (➡️) to increase intensity or the minus icon (⬅️) to decrease intensity of the trace or graticules.

Note: The intensity can also be adjusted by selecting anywhere in the slider or selecting and dragging the slider circle left or right.



4. Close the Display settings menu.

Set Time and Date

To set the internal time and date used by the instrument to record events.

Note: When the time and date settings are changed, the instrument must be rebooted to implement the changes.

1. Select the **Settings** icon () to open the Settings menu.
2. Select **Utilities** to open the Utilities submenu.
3. Select **Time and Date** to open the submenu. The submenu has two tabs: TIME ZONE and TIME AND DATE.

 **Caution:** Excess time changes can cause the loss of all license files. If the instrument license files are lost, servicing is required. Time should be changed less than ± 1 hour. Use the TIME ZONE tab to set the local time.

4. Select **TIME ZONE** to open the submenu.



5. Select the Time Zone drop-down list to select the correct time zone offset for your location. The selection names include the time offset from UTC and major cities in those time zones.
6. Select **TIME AND DATE** to open the submenu.

7. Adjust the time and date using the up and down arrows as needed. The time setting uses a 24-hour clock, so no AM/PM setting is required.



8. When you are done setting the time and date, select **Save**.
9. The message box displays and asks whether you want to reboot the instrument now or later to implement the time and date changes. Select one of the options:
 - Select **OK** to reboot the instrument immediately and implement the changes.
 - Select **Cancel** to end the operation.

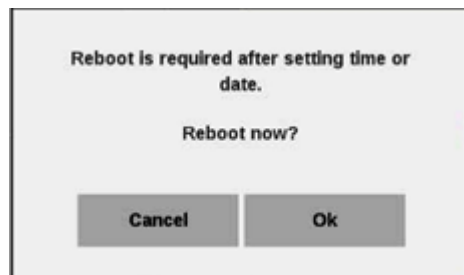

Upgrade Instrument Firmware

Before You Begin

Telestream releases updates to product firmware to add new features or to fix reported problems. Check the Telestream website regularly for new firmware releases.

You do not need to perform a firmware upgrade if your instrument has the latest version of firmware already installed. To determine if the firmware on your instrument must be upgraded:

1. Power on the instrument.
2. Verify the current software version installed on the instrument:
 - a. Select the **Settings** icon () to open the Settings menu.
 - b. Select **Utilities** to open the Utilities submenu.
 - c. Select **Version** to open the Version display.
 - d. In the Software section, make a note of the version number installed on the instrument.

Instrument firmware version number

3. Verify the latest version of firmware at the Telestream website:
 - a. Use a web browser and go to the Telestream website software page: www.telestream.net/video/resources.htm#Software.
 - b. Click the product and model title that best matches your instrument (such as PRISM) and in the list, find the software-upgrade package for your instrument.
 - c. Note the latest version number of the software-upgrade package(s).

Website firmware version number

4. If the latest firmware version at the website is newer than the version on your instrument, you should upgrade the firmware.
5. Click the Firmware Release version for your instrument to download the update.



Caution: *After the instrument has started the upgrade process, DO NOT remove power from the instrument. If you do, the instrument flash will be corrupted. The instrument must be sent to a Telestream factory service center to have the system firmware restored.*

6. Go to [Upgrade Firmware](#).

Note: The time required to complete the upgrade is about 15 minutes.

If you want the details of what has changed in the release, download the Release Notes for the version.

Note: If power to the instrument is lost before it begins erasing the internal flash, you can restart the firmware upgrade after the instrument reboots.

Upgrade Firmware

1. Copy the upgrade file with a .bin file extension from the upgrade package onto a USB memory device. You need approximately 1 GB of available space on the USB device.

Note: If the upgrade package included a readme.txt file, read the file before performing the upgrade. The file contains important information about the firmware release.

2. Insert the USB memory device into a USB port on the PRISM monitor.
3. On the PRISM monitor, select the **Settings** icon () to open the Settings menu.
4. Select **Utilities** to open the Utilities submenu.
5. Select **Firmware Upgrade**. After the USB device has been scanned, the display lists all of the files on the USB device with a .bin file extension.
6. Select the file in the list and then select **Install** to start the upgrade.





While the upgrade is in process, a message box appears stating that the firmware installation is in progress.

Caution: *Removing the USB device or powering off the instrument before the upgrade is complete can cause upgrade failure. To prevent upgrade failure, wait until the Installation Complete message box is displayed before performing these actions.*

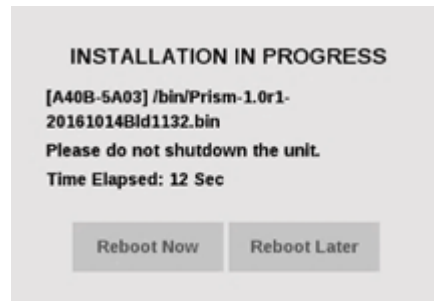
Note: The upgrade may take up to five minutes.



7. When the install is complete and the reboot options are available, select **Reboot Now**.
8. Select the **Activity** icon () to view the devices mounted to the instrument.
9. Select the **Eject** icon () to unmount the USB drive from the instrument.
10. Remove the USB device from the PRISM monitor.
11. Shut off the instrument:
 - a. Select **Settings**.
 - b. Select **Utilities**.
 - c. Select **Power**.
 - d. Select **Power Down Now**.
12. Press the Power/Standby button on the instrument front panel to turn the instrument on.

Verify Firmware Upgrade

1. Select the **Settings** icon () to open the Settings menu.
2. Select **Utilities** to open the Utilities submenu.
3. Select **Version** to open the Version display.
4. Verify the displayed firmware version number matches the version of the firmware upgrade package you installed.

Upgrade Software License

A software license upgrade allows you to add optional software features to your instrument. Go to www.telestream.net for the latest list of features that can be licensed

Install Software License Upgrade

To activate your licenses your instrument must be accessible by another computer on your local network. Your instrument does not need to access the internet.

To activate your licenses:

1. Connect your PRISM instrument to a local network and turn on power.
2. After the instrument has booted, find the IP address: select **Settings**, then **Network**, and finally select the **STATUS** tab.
3. Copy the IP address of the instrument under the CONTROL IP PORT heading.
4. Enter the IP address in a web browser.
5. Select **License Portal** and follow the instructions on the page.

For further assistance, contact our technical support team:
www.telestream.net/telestream-support/video/support.htm.

Verify Software License Upgrade

1. Select the Settings icon () to open the Settings menu.
2. Select **Utilities** to open the Utilities submenu.
3. Select **Options** to open the Options display.
4. Verify that the displayed option(s) match the option(s) you installed.

Troubleshooting

Create Diagnostics Report

You can download a zip file containing a service report of instrument diagnostics using the Settings menu. If your instrument needs service, you may be asked to provide the diagnostics file to Telestream to aid in troubleshooting problems with the instrument.

1. Select the **Settings** icon () to open the Settings menu.
2. Select **Utilities** to open the Utilities submenu.
3. Select **Diagnostics** to open the Diagnostics submenu.
4. Insert a USB device into one of the USB ports on the PRISM monitor.
5. Select **Save Diagnostics** to save the diagnostics report to the USB device.

Functions

This section describes additional functions available on the PRISM monitor.

- Headphone and speaker volume, balance, and source adjustment
- Stream Capture

Headphone/Speaker Volume, Balance, Device, and Source Adjustment

In addition to the optional integrated speakers on MPX, headphones can be connected to MPI or MPX products.

- MPI audio output rear panel connector
- MPX audio output rear panel connector
- MPX front panel headphone port

To access the volume, balance, and source controls, select the **Volume** icon ()

The available options:



- Select the audio device to use.
- Select the source from the list of available channel pairs.
- Use the slider or arrow buttons to turn the volume up or down.
- Use the slider or arrow buttons to adjust the audio balance left or right.
- Select the mute button to mute the audio.
- Select the downmix button to listen to a downmixed group of channels.

If the downmix button is not visible, as in the next illustration, the Program configuration might not be on or set.



Enable the Downmix Button

Note: The Dolby program is configured automatically, based on metadata.

1. Select the **Settings** icon () to open the Settings menu.
2. Select **Inputs** to open the Inputs submenu.
3. Select the input with the channels to downmix.
 - a. If the input is SDI, select **AUDIO**.
 - b. If the input is 2022, select **AUDIO**.
4. Check the Program Configuration is on and configured for the input.
5. Select **Save**.
6. Select the **Volume** icon () . The downmix button is visible.

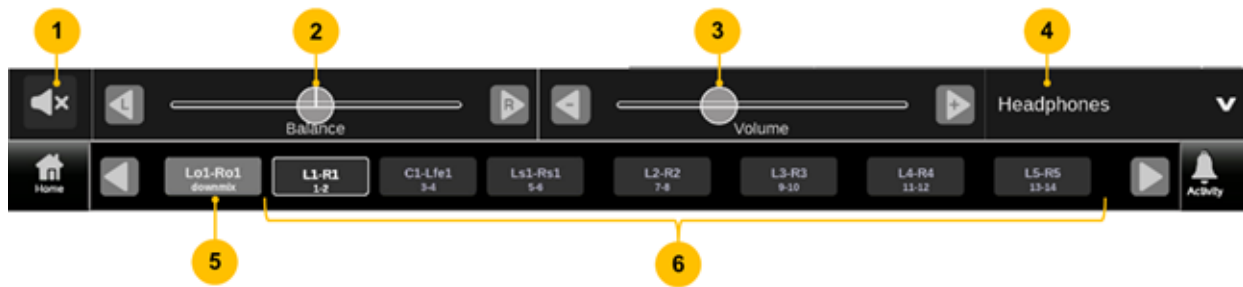

Audio control features and descriptions

Number	Description
1	Mute: Mute or Unmute Audio
2	Balance: Left / right balance control of selected audio pair
3	Volume: Volume control of selected audio pair
4	<p>Audio device: Output audio device to control. This can be headphones using the audio ports or USB inputs, or the internal speakers on MPX (requires option SPKR).</p> <p>The name of the audio device in the list depends on what port is used and the device itself:</p> <ul style="list-style-type: none"> Speakers: MPX integrated speakers Headphones: Headphones plugged into the front or rear panel audio ports USB AUDIO DAC: Headphones plugged into the MPX2-DUALDSP external display product audio ports Unknown: Unidentified audio device plugged into the front or rear panel USB ports <p>If a USB audio device supports device descriptors, the vendor supplied device name appears in the list.</p>
5	Downmix: Audio channel group to monitor channels mixed down to stereo or mono (visible when only Program Configuration is on and set)
6	Audio source: Audio channels to monitor

 **WARNING:** To avoid damaging your hearing, always turn the volume down to the minimum before you put on headphones and then turn the volume up slowly.

Capture

The Capture feature has two modes: Screenshot and Stream.

Screenshot capture takes an image of the entire screen and saves it to a USB device.

Stream capture creates a PCAP file capturing up to 2GB of data on a USB device for further analysis. Both modes are useful for comparing sources or capturing transient events.

Requirements to use the Capture feature:

- MP2-IP-MEAS option installed
- USB 3.0 drive connected to the rear panel of the PRISM monitor

Note: For the fastest capture rate with the Stream Capture, we recommend using a USB 3.0 drive, plugged into one of the USB 3.0 ports on the rear panel of the instrument. Using a USB 2.0 drive or USB 2.0 ports can cause the stream capture to take longer.

Note: Maximum stream capture PCAP files are approximately 2GB in size.

Capture a Screenshot

1. From the Settings menu, select **Capture**.

Note: If the Capture configuration menu does not appear under the Settings menu, option MP2-IP-MEAS is not installed, but screen captures are still functional.

2. Select **Screenshot** under SELECT CAPTURE TYPE.

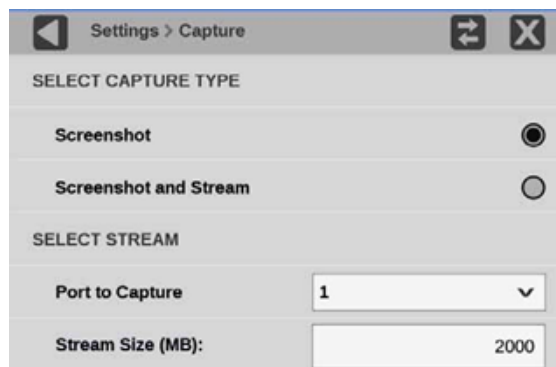

- On the application bar select the **Capture** icon ().

A screenshot is saved to the device.

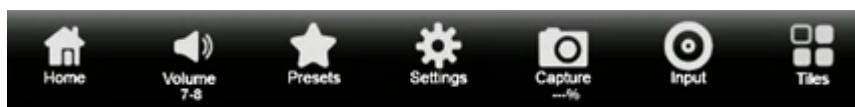

Note: The screenshot API is for Telestream internal use only. If you need to remotely save a screenshot to a flash drive, use VNC.

Take a Stream Capture

- Verify there is a USB drive connected to the PRISM monitor.
- Select the **Settings** icon ().
- From the Settings menu, select **Capture**.

Note: If the Capture configuration menu does not appear under the Settings menu, option MP2-IP-MEAS is not installed and stream captures are disabled.

- Select **Screenshot and Stream** under SELECT CAPTURE TYPE.
- Use the Port to Capture drop-down menu to select from inputs 10/25GE SFP 1 or SFP 2.

Note: When capturing on a port configured for 25 Gb data rate, the maximum total bitrate on the port must be less than 15 Gbps. Data packets captured in the PCAP file may be dropped if the total bitrate exceeds this limit.

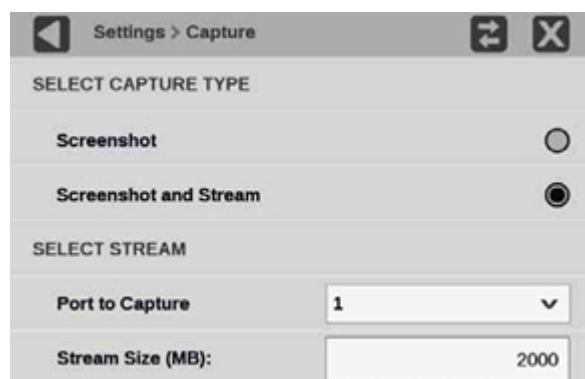

- Select in the Stream Size (MB) field to set the size of the capture.

Note: The minimum stream size is 1MB and the maximum size is 2000 MB.

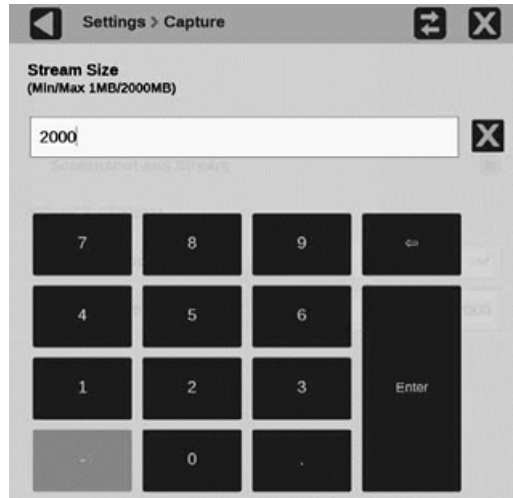

7. Select the close icon (X) to close the settings.
8. Select the **Capture** icon () on the application bar to start the process. When the capture type is Screenshot and Stream, a percentage is displayed under the Capture icon.

Note: During capture the Aux Out signal is turned off, and Pictures and Traces are blanked.

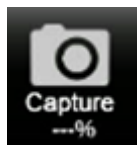



Note: Select the Capture icon again to stop the stream capture early. The Capture icon is the only element you can interact with on the PRISM monitor while the capture and save are taking place.

9. A screenshot and pcap file are saved to the attached USB device. The name of the file and the path to the file on the USB device are displayed after the save is complete.
10. Select **OK** to close the menu.

Application Information

This section describes the monitoring and measurement applications available on the PRISM monitor. Each of these applications can be viewed in quarter-screen, half-screen, or full screen mode; double tap in the application to change between modes.

To see the All Application menu, select the **Tiles** icon () and then select the All Application menu icon (.

Note: Some displays require a specific option to be installed. For example, the IP Graph display is not accessible unless you have Option MP2-IP-MEAS.

Base Instrument Applications







These applications are available on every PRISM monitor, unless otherwise noted:

Application icons	Description
	<i>Waveform Application:</i> Use this to view the voltage versus time display of the video signal.
	<i>Vector Application:</i> Use this to call up the Vector, which plots color difference signals for viewing hue and amplitude, but not luminance.
	<i>Audio Application:</i> Use this to view a level meter display of the audio in the monitored signal, along with a Lissajous display and Channel Correlation meter for monitoring two channel audio phase (Lissajous, Channel Correlation, and Audio Session require Option MP2-AUD). Also included are Test level and Peak program level indicators.
	<i>Picture Application:</i> Use this to view the picture decoded from the incoming video signal.
	<i>Video Session Application:</i> Use this to view information about the format of the signal and metrics for SDI Format, VPID SMPTE ST352, Bit Level, and CRC Status.
	<i>Timing Application:</i> Use this to view timing offsets between the incoming SDI video signals and Black Burst / Tri-Level Sync external reference signals.
	<i>Event Log Application:</i> Use this to view a log of detected errors.
	<i>IP Status Application:</i> Use this to see an overview of the monitored IP stream and see the status of each program in the stream.

Option MP2-IP-MEAS



These additional applications and feature are available when Option MP2-IP-MEAS is installed:

IP Stream Capture: This feature allows the capture IP streams to a PCAP file. The maximum capture size is 2 GB, which allows for the capture of 10 seconds of HD video.

Application icons	Description
	<i>IP Session Application:</i> Use this to view various performance parameters of the IP stream including Layer 2, video and PTP parameters.
	<i>IP Graphs Application:</i> Use this to view trend graphs of various performance parameters of the IP stream including total bit rate, session bit rate, PIT, RTP sequence errors, video CRC errors, and TS-DF (Time Stamped Delay Factor).
	<i>PIT Histogram Application:</i> Use this to view a histogram of the PIT (Packet Interval Time) to monitor network delay variation statistics.
	<i>PTP Graphs Application:</i> Use this to view trend graphs of various performance parameters of the PTP signal include Master-to-Slave and Slave-to-Master delays and variances.
	<i>Timing Application:</i> Use this to add features to standard Timing application including to view timing offsets between the incoming 2022-6 and 2110-20 video signals and PTP signals.
	<i>Stream Timing Application:</i> Use this application to view the timing of the ST2110 video, audio, and data as it was received relative to the embedded RTP time stamps.



Option MP2-GEN

These additional applications are available when MP2-GEN is installed:

Application icons	Description
	<i>IP Generator Application:</i> Use this to provide an IP test signal to check the receiver device and signal path.
	<i>SDI Generator Application:</i> Use this to provide an SDI test signal to check the receiver device and signal path.

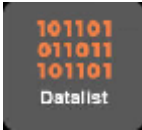

Options MP2-ENG and MP2-QC

These additional applications are available when Option MP2-ENG or MP2-QC is installed:

Application icons	Description
	<i>Datalist Application:</i> Use this to see the digital data contained in SDI frames to perform in-depth monitoring and analysis of incoming SDI data
	<i>ANC (Ancillary Data) Session Application:</i> Use this to monitor all ancillary data present in a signal.

Option PHY





These additional applications are available when Option PHY is installed (software option MP2-FMT-4K required for 12G support):

Application icons	Description
	<i>Jitter Application:</i> Use this to display the wave shape of the jitter and allows you to view additional time-domain information.
	<i>Eye Application:</i> Use this to view an eye pattern diagram of the SDI input only.

Option MP2-PROD

These additional applications and feature are available when Option MP2-PROD is installed:

Convert to Rec. 709: This feature adds a setting to allow the trace displays to convert camera logs to Rec. 709.

Application icons	Description
	<i>Stop Display Application:</i> Use this to monitor video signals with a variety of transfer functions in a consistent manner.
	<i>Diamond Application:</i> Use this to reliably detect invalid colors.
	<i>Lightning Application:</i> Use this to show luma and chroma amplitudes and verify component timing using a color-bar signal.
	<i>CIE Application:</i> Use this to check the chromaticity of the video against various color gamut limits.

Options MP2-DLBY and MP2 AUD

This additional application is available when Option MP2-DLBY or MP2-AUD is installed:

Application icons	Description
	<i>Dolby Status Application</i> : Use this to show metadata content in the selected Dolby audio stream.





Note: Of the trace applications (Waveform, Vector, Stop, Diamond, Lightning, and CIE) up to 4 can be displayed at the same time in formats: SD; HD 720p, 1080p, 1080i; 3G Level A. All other formats can display up to 2 trace applications at a time.

Viewing Installed Options

To view options installed on the instrument, select **Settings**, then **Utilities**, and then **Options**.

Status Indicators

Many of the application displays include status icons, which provide a quick method for viewing signal status. These icons may appear:

-  Indicates the signal parameter has not been in an error condition.
-  Indicates the signal parameter was in an error condition but the error has now cleared.
-  Indicates the signal parameter is currently in an error condition.
-  Indicates the signal parameter is not being monitored for an error condition.

Waveform Application

The Waveform display is a signal-level versus time display of the video signal.

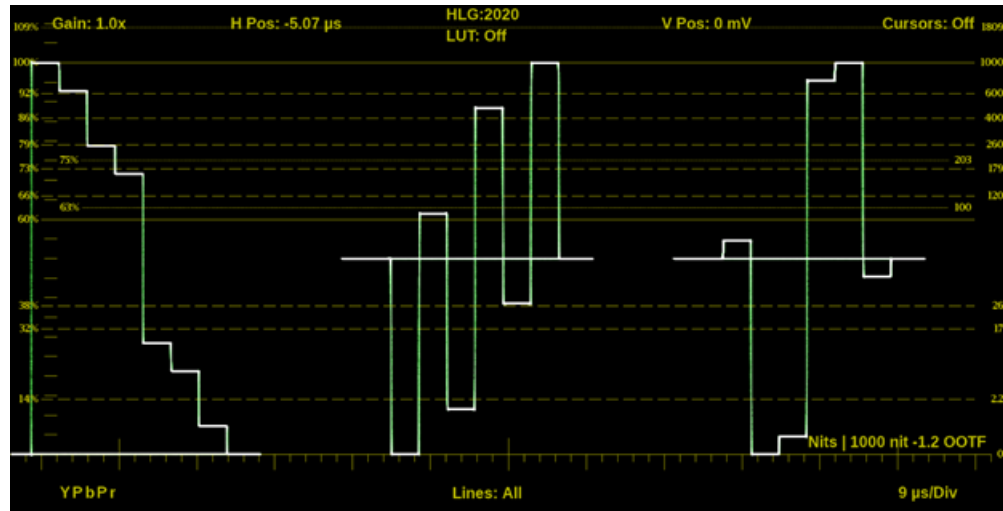

Waveform Settings Menu

Note: The Move icon (↔) is in the settings menu header. Select this icon to move the settings left of right.

Open the Waveform Settings menu:

1. Select the **Tiles** icon (🧩).
2. Select the tile with the Waveform application.

3. Select the **Tile** icon ().



Display Style

Select one of the buttons to choose how the signal components are displayed in the active tile:

- Parade: All the components are shown one beside the other.
- Overlay: All the components are drawn at the same location so they appear one on top of the other.

Sweep

Select the drop-down menu to select the waveforms to view between the lines or fields. The available sweep options depend on which display style is active.

- When the Parade display style is active you can select from 1 line or 1 field.
- When Overlay display style is active you can select from 1 line, 2 line, 1 field, or 2 field.

Display Mode

Select the drop-down menu to select from these choices (only available while displaying SDI inputs) in the menu:

- Y: Displays the input as Luma (Y) components.
- RGB: Displays the input as Red (R), Green (G), and Blue (B) components.
- YPbPr: Displays the input as Luma (Y) and color difference (Pb, Pr) components.
- YRGB: Displays the input as Luma (Y), Red (R), Green (G), and Blue (B) components.

Filter

Select one of the buttons to set the waveform filter. This is useful for isolating a specific characteristic of the input. For example, you may enable a Low Pass filter for quick camera exposure setting.

These filters are available:

- Flat: Display with the full available bandwidth.
- Low Pass: Display only the low frequency part of the signal.

Graticule

Select the drop-down menu to choose a vertical scale value.

Note: The Code Value vertical unit is a hex value. The Stop, Reflectance, and Nits scale are drawn differently depending on the gamma setting in the input menu.

Convert to Rec. 709

Move this slider to **On** to allow the trace displays to convert the Gamma and Color Gamut settings for the signal to SDR Narrow and BT. 709 (requires Option MP2-PROD).

Note: Conversion to Rec. 709 automatically converts to BT.709, otherwise the graticule selection must be manually changed. (See [Configure Instrument for HDR/WCG Monitoring](#).) Conversion to Rec. 709 mode is not supported for SD signals.

Line Select

Move the slider to On to select 1 Line or Off to select All Lines.

If Line Select is set to **On** (Line Select: Line 1), the display only shows results for the selected line in the picture. The line can be selected using the on-screen tools; see [Line Select Function](#). Or the line can be selected directly on the Picture.

Show Active Area Only

Turn this on to remove the trace of vertical / horizontal blanking data.

Gain

Select from the options to set to x1, x2, x5, or x10.

Magnification

Select from the options to set to the magnification to Best View, x1, x10, x20, x25, or x50.

Waveform Application On-screen Tools

You can change the gain, horizontal position, vertical position, cursors, display mode, display format, and selected line, without opening the Waveform settings menu, through on-screen tools. Select the tool/button for the setting you want to adjust. All the available tools are located on the top and bottom of the display and are highlighted for a few seconds when the application is first opened or if you select anywhere in the middle of the application tile.

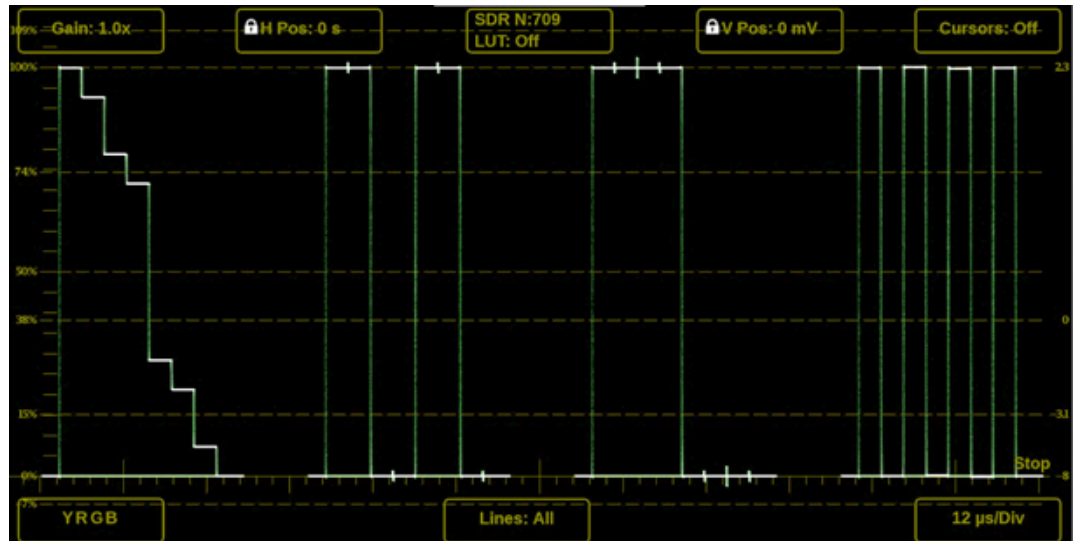

Gain

Increase or decrease the magnification of the trace display.

1. Select the **Gain** button to expand the available magnification options drop down list.
2. Select one of the preset magnifications for fixed gain.

3. Select Variable Gain; select **VAR: Off**, this changes it to VAR: On. Variable gain allows you flexibility in changing the gain factor between 0.5x to 20.0x.

The limits of the variable gain change depending on the gain factor you select.

- 1.0x has a range of 0.25x to 2.00x gain.
- 2.0x has a range of 0.50x to 4.00x gain.
- 5.0x has a range of 1.25x to 10.00x gain.
- 10.0x has a range of 2.50x to 20.00x gain.

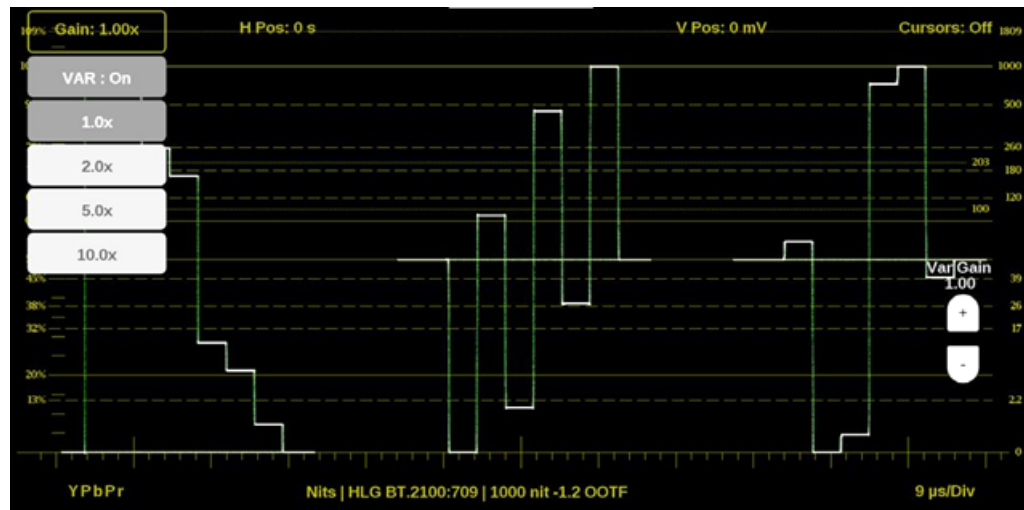

To adjust the gain:

- On a touchscreen, use a pinch gesture to change the scale of the trace for large increments.
- For fine increments, select the plus or minus buttons to adjust the gain.
- The scroll wheel on a mouse adjusts the variable gain.
- Use the **Reset** icon (🔄) to remove variable gain adjustments.

Horizontal and Vertical Position

Adjust the position of the trace display.

1. Select the **H Pos** button to allow incremental adjustment of the horizontal trace.
 - Select and drag to move the trace on the touchscreen. This method can be performed without using the button.
 - Use a mouse scroll wheel to move the trace.
 - For incremental adjustments, use the plus or minus buttons to adjust the horizontal position.
 - Select the **Reset** icon (🔄) to reset the horizontal position adjustment to default.

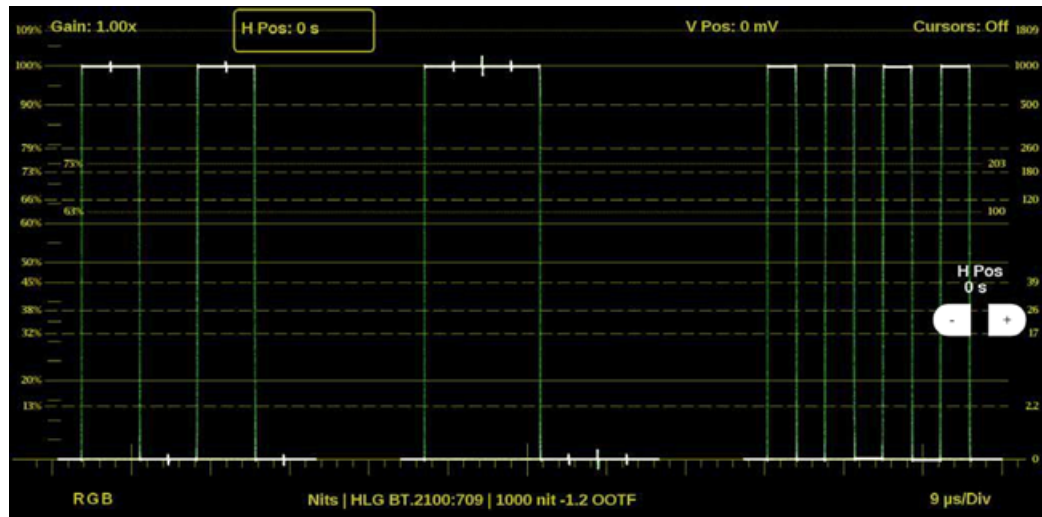

2. Select the **V Pos** button to adjust the vertical trace.
 - Select and drag to move the trace on the touchscreen. This method can be performed without using the button.
 - Use a mouse scroll wheel to move the trace.
 - For incremental adjustments, use the plus or minus button to adjust the vertical position.
 - Use the **Reset** icon () to reset the vertical position adjustment to default.

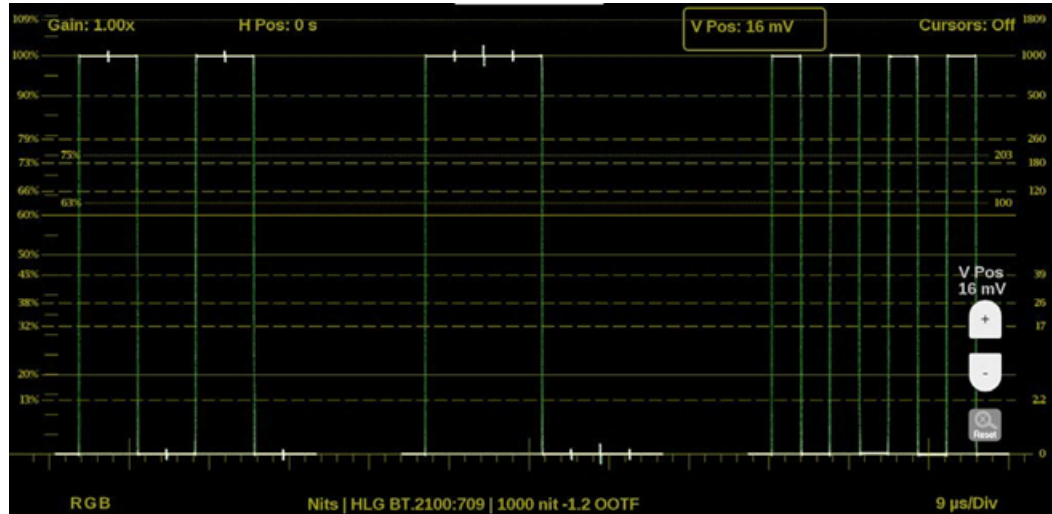

Cursors

Make precise measurements with time and voltage cursors.

1. Select the **Cursors** button to show the time and voltage cursor options.
2. Select the **T** button to **On** to display two time cursors.
3. Select anywhere on the display to hide the **T** and **V** buttons.
4. Select and drag anywhere on the T1 or T2 cursor to mark exact times in the trace. The cursors highlight yellow when moved. The timestamp of each cursor and the delta are displayed on the right side of the application.

Note: The cursor tab provides an easy way to adjust each cursor.

5. Change the **V** button to **On** to display two voltage cursors.
6. Select the **V Units** button to change the voltage units between percentage (%), millivolts (mv), or code value (CV).
7. Select anywhere on the display to hide the buttons.
8. Select, hold, and drag anywhere on the V1 or V2 cursor to mark exact times in the trace. The cursors highlight yellow when moved. The voltage measurement at each cursor and the delta are displayed on the right side of the application.

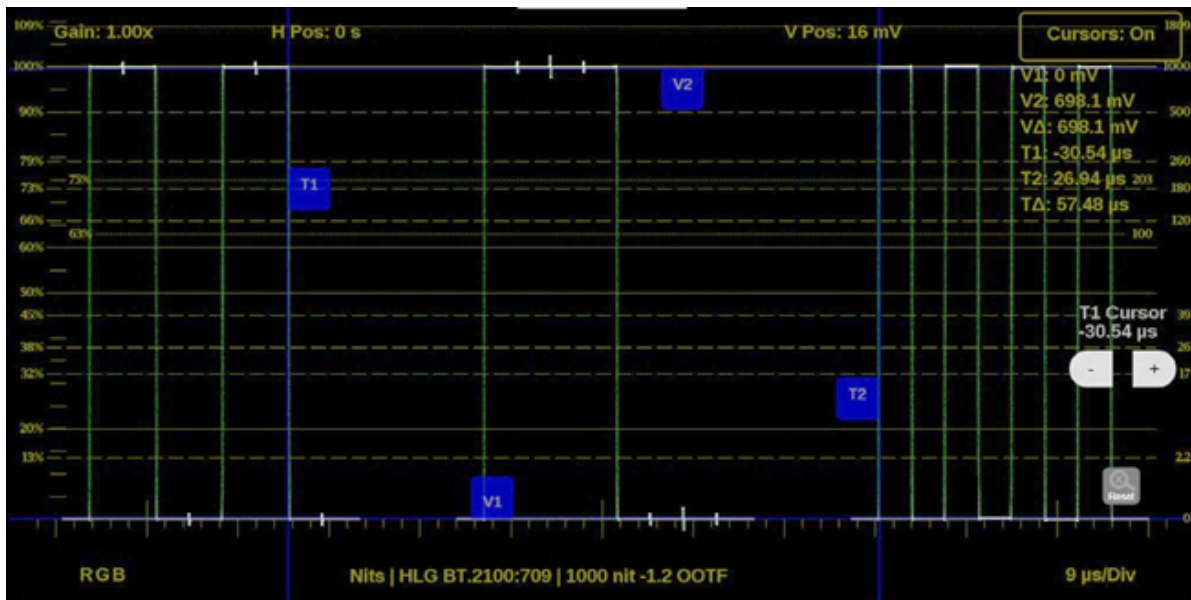

Note: The time and voltage cursor positions are retained if the trace is moved horizontally or vertically, or if the gain is adjusted.

Display Mode

Change how the waveforms are displayed.

1. Select the button in the bottom left corner of the application to expand the available display options.
2. Select one of the display options.
3. Filter each option by the individual waveforms to display.
 - Select **YPbPr** to display any combination of the Y, Pb, and Pr waveforms.
 - Select **RGB** to display any combination of the R, G, and B waveforms.
 - Select **YRGB** to display any combination of the Y, R, G, and B waveforms.

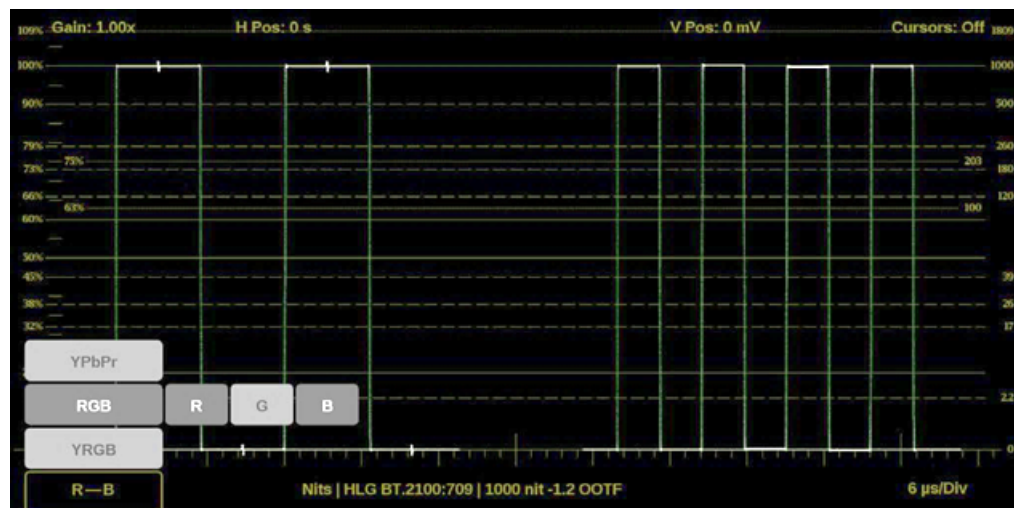

Display Format

Change the Display Style, Sweep, and Magnification of the waveform.

1. Select the button in the bottom right corner of the application to expand the available display format options.
2. Select the **Mag** option to select from the magnification options of Best View, x1, x10, x20, x25, or x50.
3. Select the Display Style option to switch between Parade or Overlay.
4. Select the Sweep options as needed. The options available depend on what Display Style is active.
 - When the Parade display style is active you can select from 1 line or 1 field.
 - When Overlay display style is active you can select from 1 line, 2 line, 1 field, or 2 field.

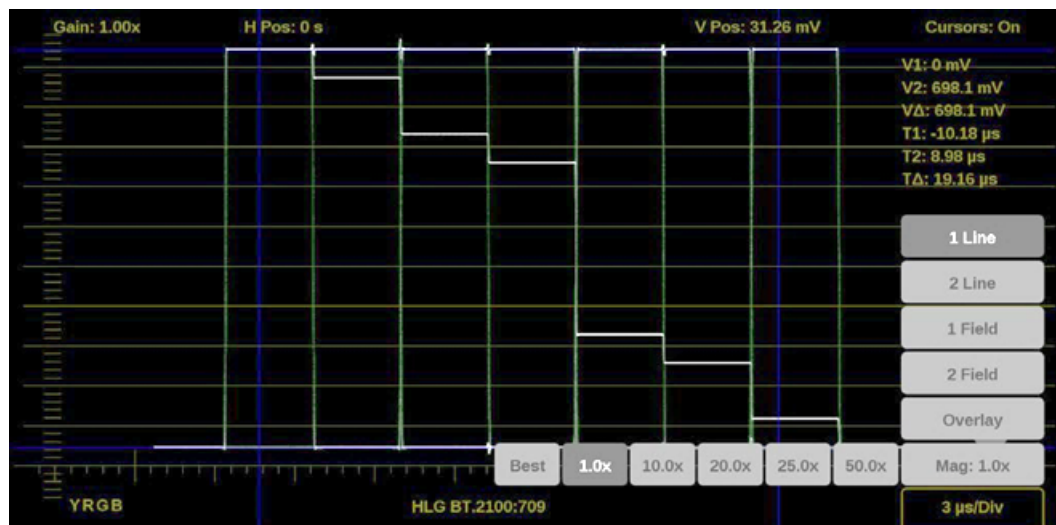

Line Select Function

Line Select allows you to select a single picture line to monitor in the display. By default All Lines is selected and all lines are monitored.

Note: The same line is selected in any trace display if line select is enabled.

To turn on Line Select (and choose the line to monitor):

1. Select the **Lines** button at the bottom of the tile.
2. Select **1 Line**.
 - To scroll through lines, select the + or – buttons.
 - To enter a specific line to monitor:
 - select **Line Sel.** and enter the line on the keypad,
 - or
 - in the Picture application, use the line-select cursor (for active lines).

Depending on the resolution in the signal, the Line Select provides different information.

- If a signal is SD, HD, 3G:
 - the *Line* number is the selected line, including vertical blanking,
 - if the signal is interlaced format, the *Fields* readout is below the Line number,
 - the *Pic Line* number is next to Line; the Pic Line is the active line number, or numbers, selected.

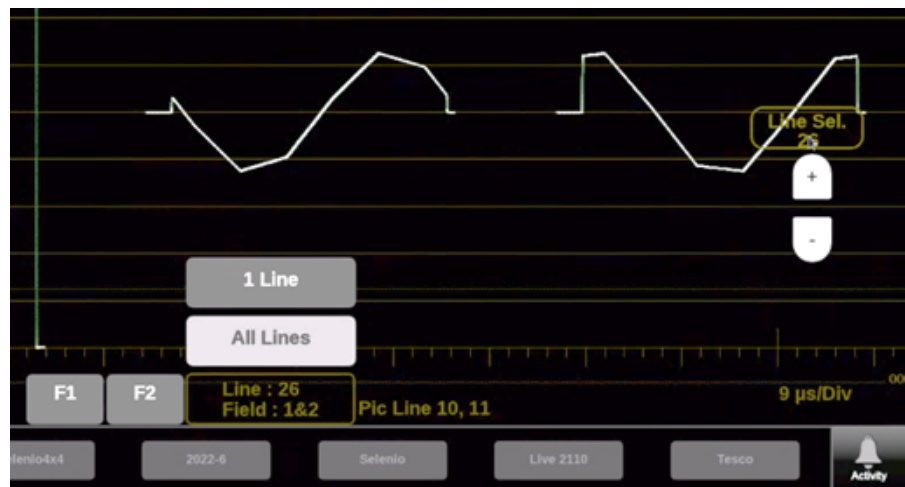

- If a signal is UHD, 4K:
 - the *Line* number is the selected raster line,
 - the *SDI Line* is the selected line including vertical blanking,
 - the *link* number appears below the SDI Line.

Note: In link, the letters (A, B, C, or D) refers to the physical links. The numbers (1, 2, 3, or 4) refers to the virtual links. For example, A3/62 indicates it is physical link 1 and virtual link 3 (in a 2-sample interleave, 12G transport).

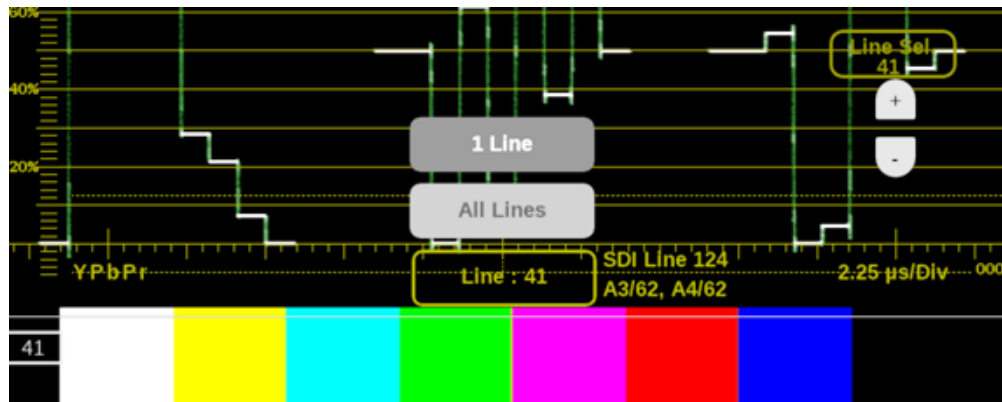

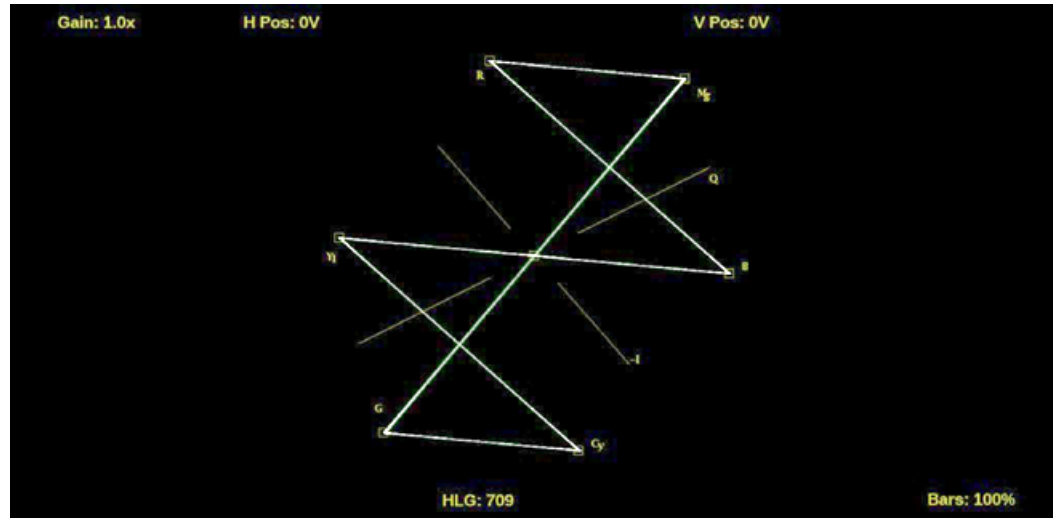

Vector Application

The Vector application provides an X-Y plot of color difference signals allowing the operator to match skin tones and color of ITU-R BT 709 or 2020 color space. With Option MP2-PROD, transfer function/color space conversion allows for an ITU-R BT 709 color space to verify wide color gamut compatibility.



Vector Settings Menu

Open the Waveform Settings menu:

1. Select the **Tiles** icon ().
2. Select the tile with the Waveform application.
3. Select the **Tile** icon ().

Note: The Move icon () is in the settings menu header. Select this icon to move the settings left of right.



Bar Targets

Select between 75% or 100% scaling.

IQ Axis

Select this to turn the IQ Axis On or Off.

Gain

Select one of the trace vector magnifications: x1, x2, x5 or x10.

Convert to Rec. 709

Turn this setting On to allow the trace displays to convert the Gamma and Color Gamut settings for the signal to SDR Narrow and BT. 709 (requires Option MP2-PROD).

Note: Set Convert to Rec. 709 to On to automatically convert settings to BT.709, otherwise the graticule selection must be manually changed. (See [Configure Instrument for HDR/WCG Monitoring](#).) Convert to Rec. 709 mode is not supported for SD signals.

Line Select

Line Select allows you to choose the picture lines to monitor in the display. Either All Lines or 1 Line can be selected.

If 1 Line is selected then the display only shows results for the selected line in the picture. The line can be selected using the on-screen tools; see [Line Select Function](#). Or the line can be selected directly on the Picture.

Vector Application On-screen Tools

You can change the gain, horizontal position, vertical position, and bar targets without opening the Vector settings menu through on-screen tools. Select the tool/button for the setting you want to adjust. All the available tools are located on the top and bottom

of the display and are highlighted for a few seconds when the application is first opened or if you select anywhere in the middle of the application tile.

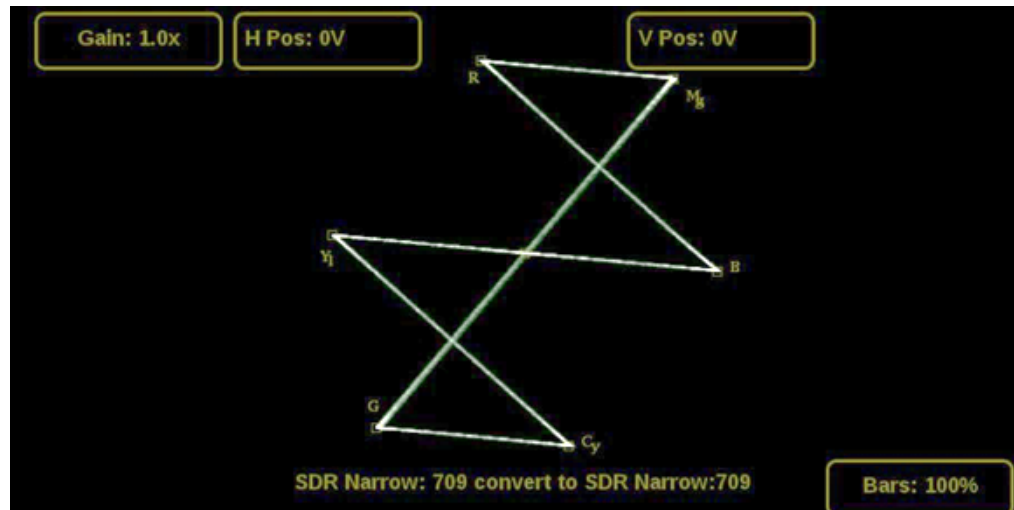

Gain

Increase or decrease the magnification of the trace display.

1. Select **Gain** to expand the available magnification options drop down list.
2. Select one of the preset magnifications for fixed gain.

3. Select Variable Gain; select **VAR: OFF** to change it to VAR: On. Variable gain allows you flexibility in changing the gain factor between 0.5x to 20.0x.

The limits of the variable gain change depending on the gain factor you select.

- 1.0x has a range of 0.25x to 2.00x gain.
- 2.0x has a range of 0.50x to 4.00x gain.
- 5.0x has a range of 1.25x to 10.00x gain.
- 10.0x has a range of 2.50x to 20.00x gain.

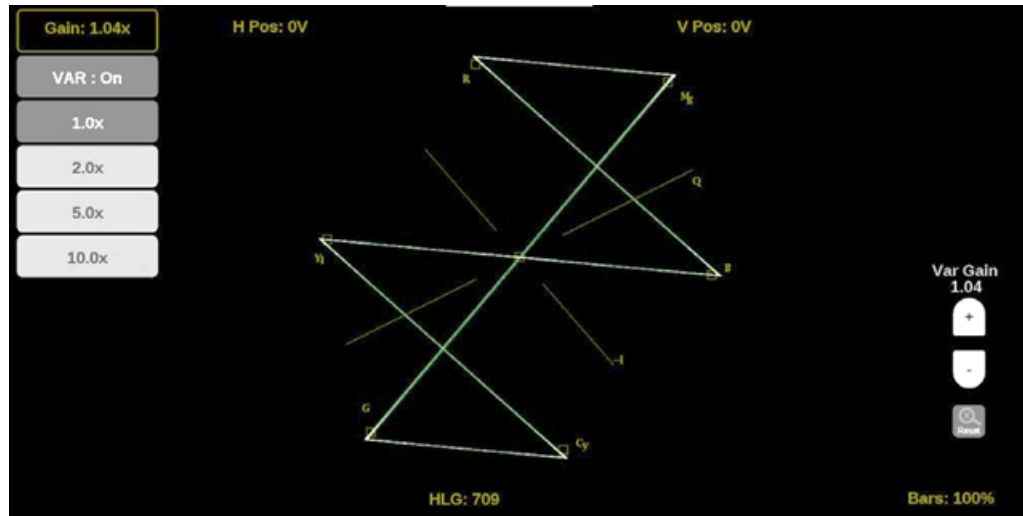

Use these methods to adjust the gain:

- On a touchscreen, use a pinch gesture to change the scale of the trace for large increments.
- For fine increments, select the plus or minus button to adjust gain. The scroll wheel on a mouse adjusts the variable gain.
- Select the **Reset** icon (🔄) to remove variable gain adjustments.

Horizontal and Vertical Position

Adjust the position of the trace display.

1. Select the **H Pos** button to allow adjustment of the horizontal trace.
 - Select and drag to move the trace on the touchscreen. This method can be performed without using the button.
 - Use a mouse scroll wheel to move the trace.
 - For incremental adjustments, use the plus or minus button to adjust the horizontal position.
 - Select the **Reset** icon () to reset the horizontal position adjustment to default.

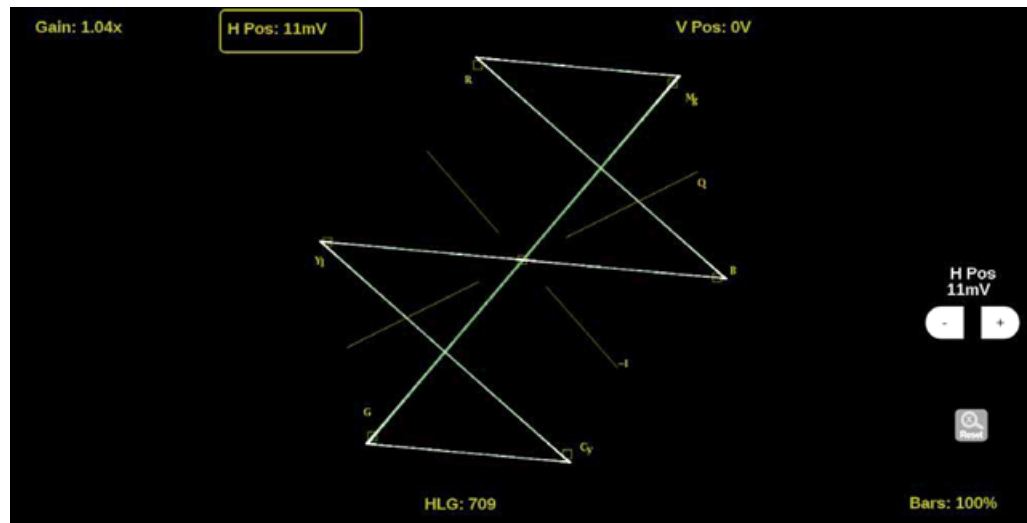

2. Select the **V Pos** button to allow adjustment of the vertical trace.
 - Select and drag to move the trace on the touchscreen. This method can be performed without using the button.
 - Use a mouse scroll wheel to move the trace.
 - For incremental adjustments, use the plus or minus button to adjust the vertical position.
 - Select the Reset icon (🔄) to reset the vertical position adjustment to default.

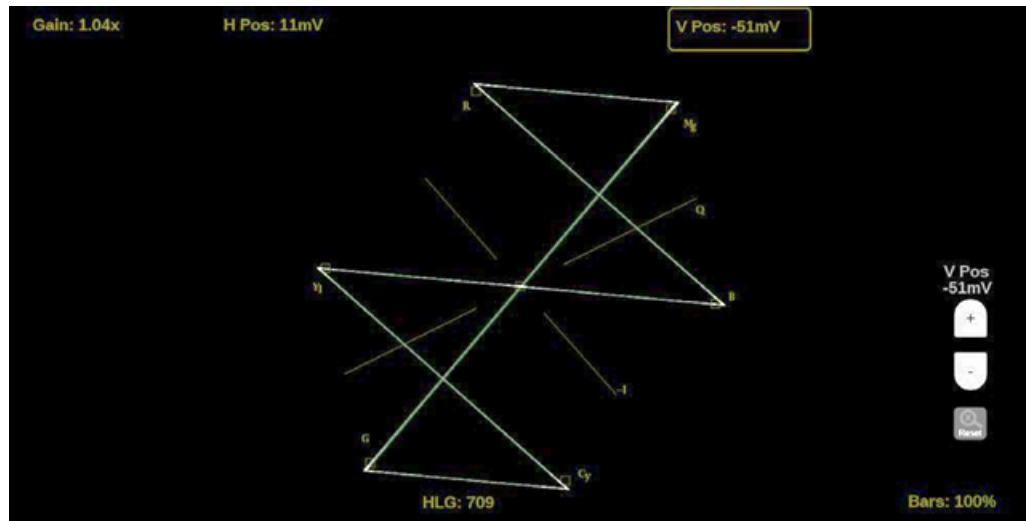

Bar Targets

Change the scaling of the Vector display.

1. Select the Bars button in the bottom right corner of the application to expand the available options.
2. Select either 75% or 100% scaling.

Line Select Function

Line Select allows you to select a single picture line to monitor in the display. By default All Lines is selected and all lines are monitored.

Note: The same line is selected in any trace display if line select is enabled.

To turn on Line Select (and choose the line to monitor):

1. Select the Lines button at the bottom of the tile.

2. Select 1 Line.

- To scroll through lines, select the + and - buttons.
- To enter a specific line to monitor:
 - select Line Sel. and enter the line on the keypad,
 - or
 - in the Picture application, use the line-select cursor (for active lines).

Depending on the resolution in the signal, the Line Select provides different information.

- If a signal is SD, HD, 3G:
 - the *Line* number is the selected line, including vertical blanking,
 - if the signal is interlaced format, the *Fields* readout is below the Line number,
 - the *Pic Line* number is next to Line; the Pic Line is the active line number, or numbers, selected.



- If a signal is UHD, 4K:
 - the *Line* number is the selected raster line,
 - the *SDI Line* is the selected line including vertical blanking,
 - the link number appears below the SDI Line.

Note: In link, the letters (A-D) refers to the physical links. The numbers (1-4) refers to the virtual links. For example, A3/62 indicates it is physical link 1 and virtual link 3 (in a 2-sample interleave, 12G transport).

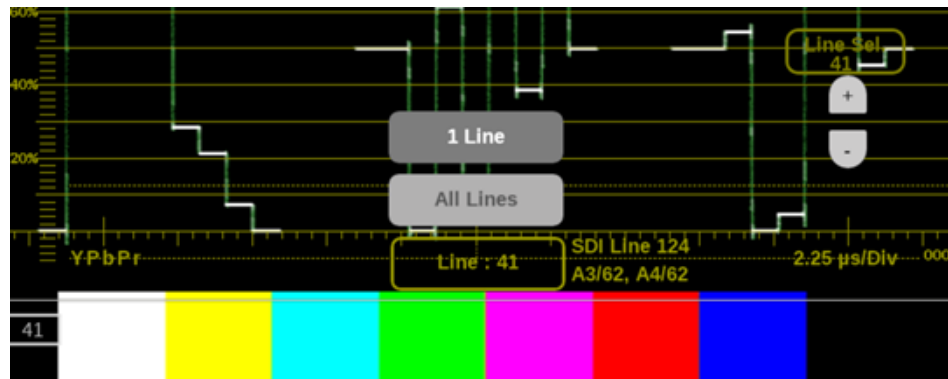

Audio Application

The Audio application provides a level meter display with multiple ballistic settings, and optional Audio Session and Lissajous with Channel Correlation displays. Audio Session shows instantaneous measurements of the level meters and the Lissajous and Channel Correlation displays show audio phase information. Dolby E decoding can be performed on a specified SDI input channel pair.

Note: The Lissajous, Channel Correlation meter, and Audio Session displays require software option MP2-AUD. Dolby E decoding requires option MP2-DLBY. The 32-channel audio support requires option MP2-FMT-8K.

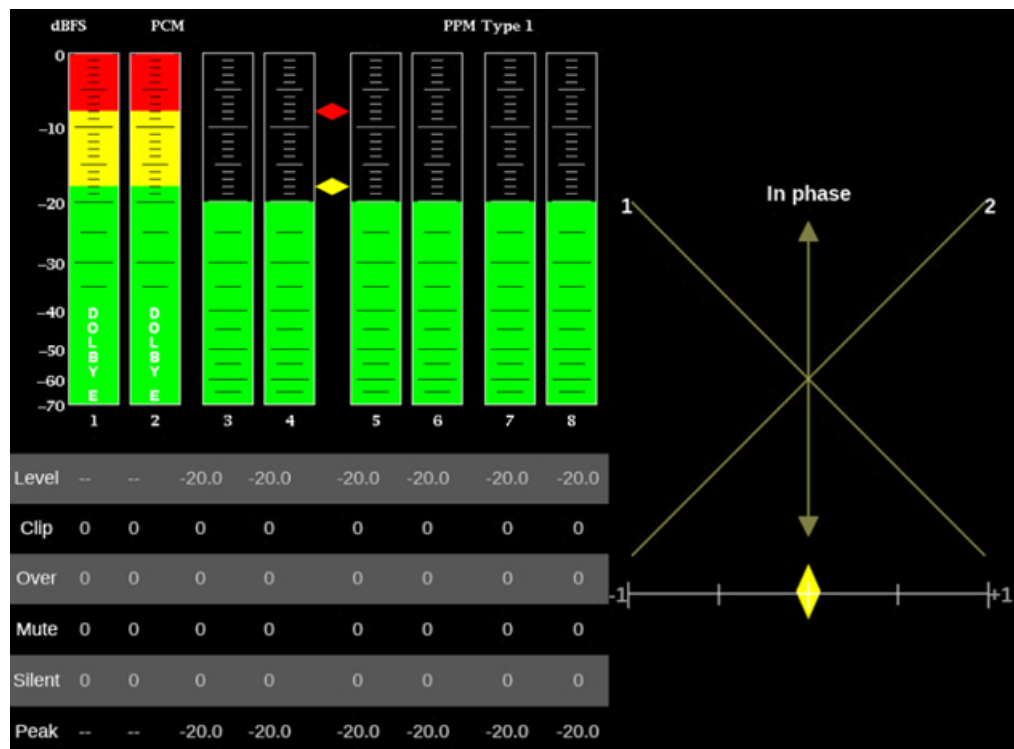

Audio Settings Menu

Note: The Move icon (↔) is in the settings menu header. Select this icon to move the settings left of right.

Open the Waveform Settings menu:

1. Select the **Tiles** icon (🧩).
2. Select the tile with the Waveform application.
3. Select the **Tile** icon (⚙️).

Lissajous Display

The Lissajous display is a visual of a user-specified pairing of channel inputs with a channel correlation meter.

To turn on the Lissajous display, in the Audio Settings, in Aux Display, select Lissajous.

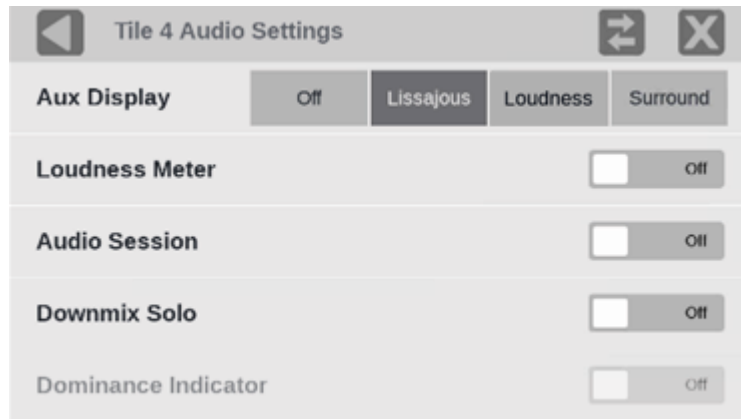

The Lissajous display appears to the right of the Audio bars.

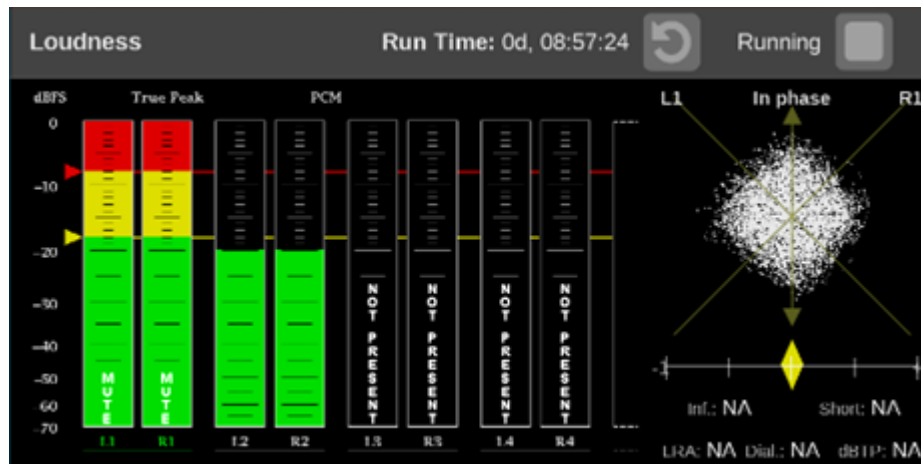

Loudness Display

The Loudness display is a visual of the audio loudness measurements.

To turn on the Loudness display, in the Audio Settings, in Aux Display, select **Loudness**.

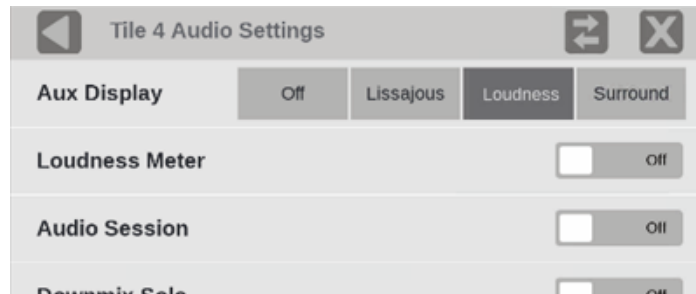

The Loudness display appears to the right of the Audio bars.

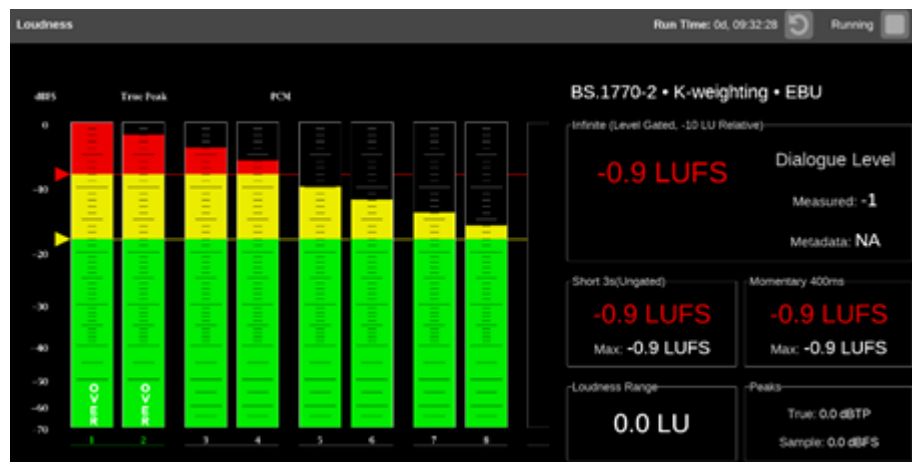

In-bar Messages

Ballistics

Displays the selected ballistics for the level meter dynamic response. Go to Audio in the global Settings menu to change the ballistics.

Level Meters

Level meters are vertical bar graphs. The height of the bar indicates the amplitude of the audio program in the corresponding input channel. The meter levels are color coded based on their relationship to the Test level and Peak Program level indicators:

- The meter bars are displayed below the Test level in a green color.
- Between the Test level and the Peak Program level, the meter bars are displayed in yellow.
- Above the Peak Program level, the meter bars are displayed in red.

Test Level and Peak Program Level Indicators

Diamond-shaped markers between the level bars indicate the default Test level (-18 dBFS) and Peak level (-8 dBFS) limits for the display. Test level is also known as Reference level or Line-up level.

Level Meter Scale and Units

By default, the units are in dB relative to full scale (dBFS). The 0 dB mark is digital Full scale.

Lissajous Display

The phase of a selected pair of audio channels is plotted on a soundstage plot. Soundstage plots the two channels at 45-degree angles, with the mono combination appearing on the vertical axis, much like a left-right image in a studio.

To select the audio channel pair to plot on the Lissajous display, select the Volume icon () on the Status Bar and choose from the list of available channel pairs.

Channel Correlation Meter

Displays the channel correlation under the Lissajous display.

- For identical or highly correlated signals, the indicator is white and moves to the far right (+1).
- For highly correlated signals, the indicator is green and moves to the right (towards +1).
- For uncorrelated signals, the indicator is yellow and tends to stay in the middle (around 0).
- For anti-correlated signals (one goes up when the other goes down), the indicator is red and moves to the left (towards -1).

This instrument displays messages within the level meter bars. These are messages that can appear and are shown in order of priority:

UNLOCKED: The instrument is not locked to an incoming signal on the indicated input channel. Data cannot be decoded and all data and other errors are ignored. This means that if an input is selected, nothing recognizable is present on the input, or if embedded audio is selected, the VIDEO input is unrecognizable.

PARITY: The incoming subframe does not have even parity as specified by the digital audio standards. The data sample is unreliable and is ignored. The level meters and Lissajous display treat the sample as a zero sample.

CRC ERR: The CRC code in the channel status packet is incorrect. Sometimes the CRC code is set to zero, indicating that the signal is missing; when this is the case, this message is not displayed.

MUTE: The number of consecutive all-zero samples equals or exceeds the # Samples for Mute setting.

SILENCE: The signal is at or below the specified Silence Level for a time exceeding the Duration for Silence setting.

V BIT: Indicates that the Validity bit is set high for one or more data samples. In the AES/EBU standard, a set validity bit indicates that the sample is not suitable for conversion to audio. By default, the level meter bars and Lissajous

NOT PRESENT: Indicates that an audio bar is not present in the current audio input. For example, if a Dolby Digital input has a coding mode indicating a reduced number of channels.

DOLBY E: Indicates that Dolby E encoded audio is present on the channel.

CLIP: Indicates the number of times the audio level was at the digital code for the maximum amplitude for ten consecutive samples.

OVER: Indicates the number of times the audio level exceeded 0dB for over-level duration of 1 second.

Note: The 32-channel audio is supported with MP2-FMT-8K license. In 8K video with Quad 12G-SDI connection, the first 16 channels (of 32 channels) comes from the link A1 and the second 16 channel comes from the link B1. The two Audio applications must be selected in two tiles to display the 32-channel audio bars.

Surround Display

To turn on the surround display:

1. In the Audio Settings, in Aux Display, select **Surround**.

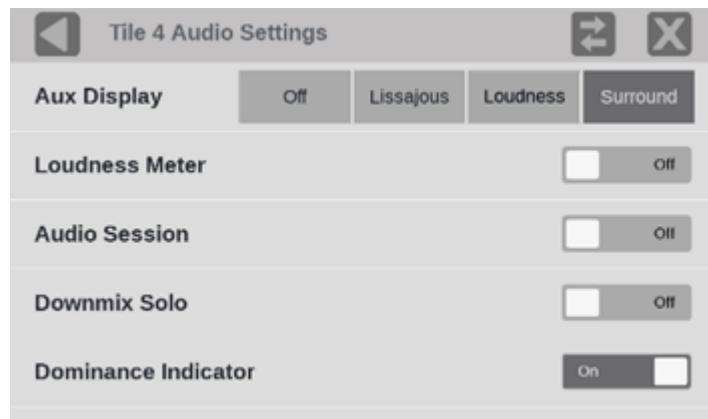

2. Set the surround Dominance Indicator to ON or OFF as needed.
3. Set the **Loudness Filter** to the type preferred. A-weighting biases the response toward that of human hearing.
4. Use the level bar display to monitor level control.

- Use the surround display to monitor relative loudness of the individual elements rendered in a surround-sound listening environment. Check the surround sound display for performance parameters and indicators.

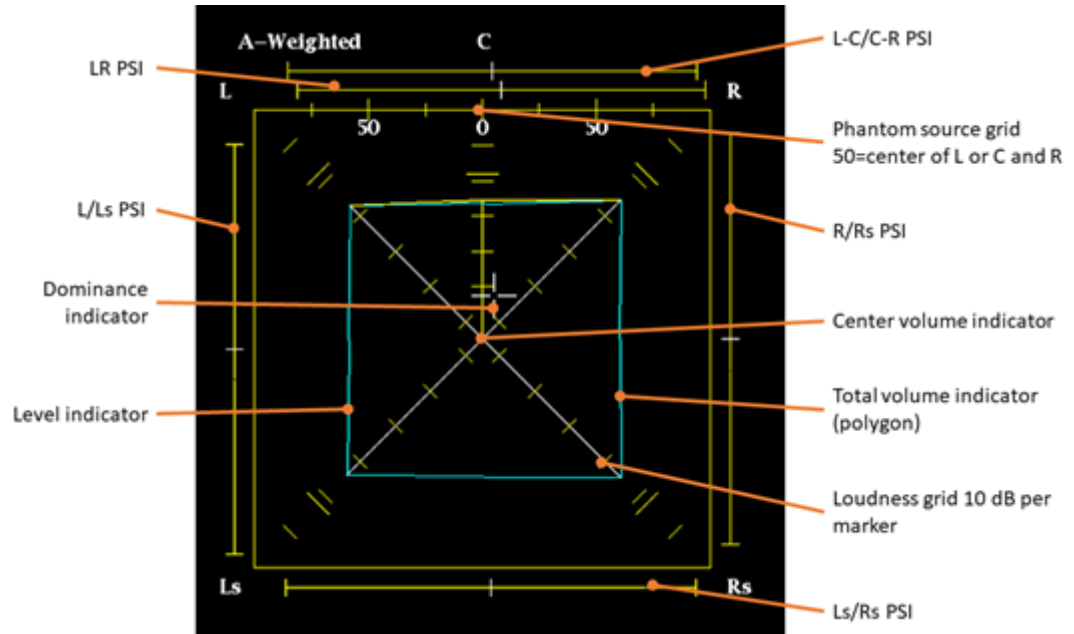

Note: The Audio Surround Sound display is provided under license from RTW GmbH & Co. KG.

- Level Indicators: indicate the audio level balance among the left (L), right (R), left-surround (Ls), and right-surround (Rs) channels as cyan lines on the Loudness Grid.
- Loudness Grid: the ruled scale, radiating from the center, on which the level indicators register their audio level and balance. The scale has tic marks at 10 dB intervals. An additional tic mark indicates the –18 dB level. The –18 dB and –20 dB levels are typically used for aligning audio levels.
- Total Volume Indicator: the cyan polygon formed by connecting the level indicator end points, showing the total sound volume of the L, R, Ls, and Rs channels. Each connecting line bends away from the center if the two signals have a positive correlation, bends toward the center if the signals have a negative correlation, and do not bend if the signals are uncorrelated.
- Center Volume indicator: displays the sound volume of the center channel as a vertical yellow bar between the L and R channels, and connects the ends of the L, C, and R audio level indicators with straight lines.
- Channel-Pair Phantom Sound Indicators (PSIs): located on each side of the Surround Sound display, indicates the location of potential phantom sound sources formed by adjacent channels. The white tic marks on these moving bar indicators show the phantom source locations. The bar length indicates the correlation between the adjacent channels. A short-to-medium length green bar

indicates positive correlation between the channels, forming a localized phantom sound source located at the white tic mark. The bar grows to full length and changes color to yellow as the correlation moves to zero, indicating a wide, non-localized sound image. The bar changes color to red for adjacent channels with significant negative correlation. For negative correlations, the ends of the PSI for the L and R channels continue to grow at a 45° angle while the other PSIs remain at full length.

- Center-Pairs Phantom Sound Indicator: a fifth PSI at the top of the display shows potential phantom sources formed by the LC channel pair and the CR channel pair. If the L, R, and C channels all have the same signal level, the white tic mark on the bar appears directly above the C level indicator. The white tic mark moves right or left depending on the relative balance between the three channels. A short bar to the left of the white tic mark indicates a positive correlation between L and C. The bar grows as the correlation decreases. Like the L-R PSI, the bar continues to grow at a 45° angle for negative signal correlations. The bar to the right of the white tic mark behaves similarly, depending on the C-R correlation. This PSI indicator uses the same color coding as the other PSI indicators.

Usage Notes

The displays shown here are examples of how the surround sound waveform appears for some typical signal types.

Uncorrelated signals (example 1): This shows the same level in the L, C, R, Ls, and Rs channels

Sine wave test tone (example 2): This has the same level in the L,C, R, Ls, and Rs channels. All signals are in phase, creating phantom sources between the adjacent channels.

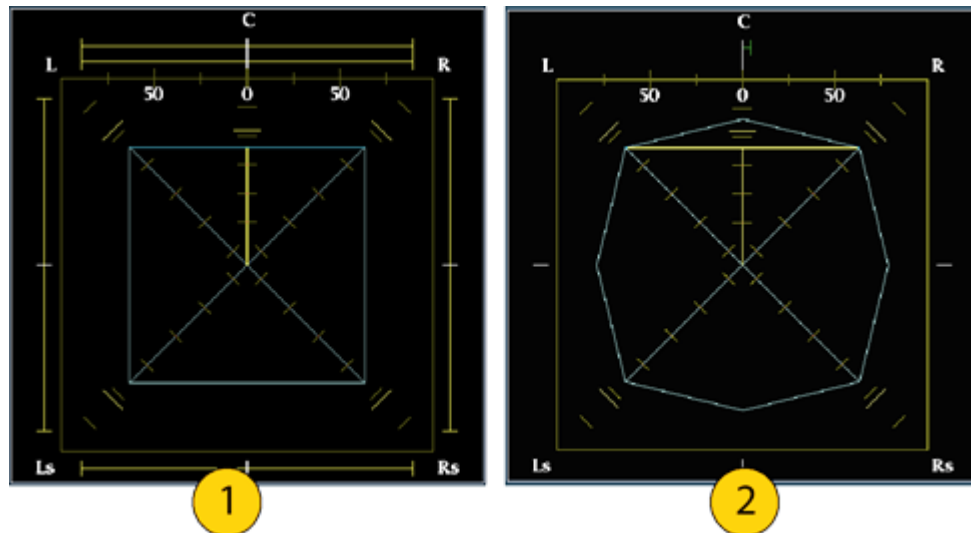

(Example 3) As in example 2, with the exception that Channel L is out of phase

(Example 4) Surround sound program with strong center channel presence

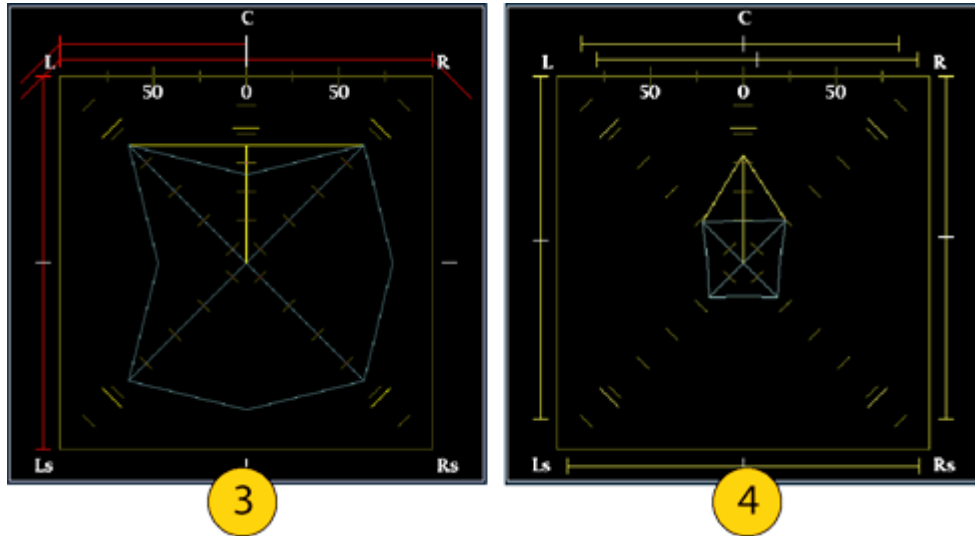

(Example 5) Surround sound program with weak center channel presence

(Example 6) Monaural signal in channels Ls and Rs, creating a phantom source in the center, as in a 3.1 surround sound system.

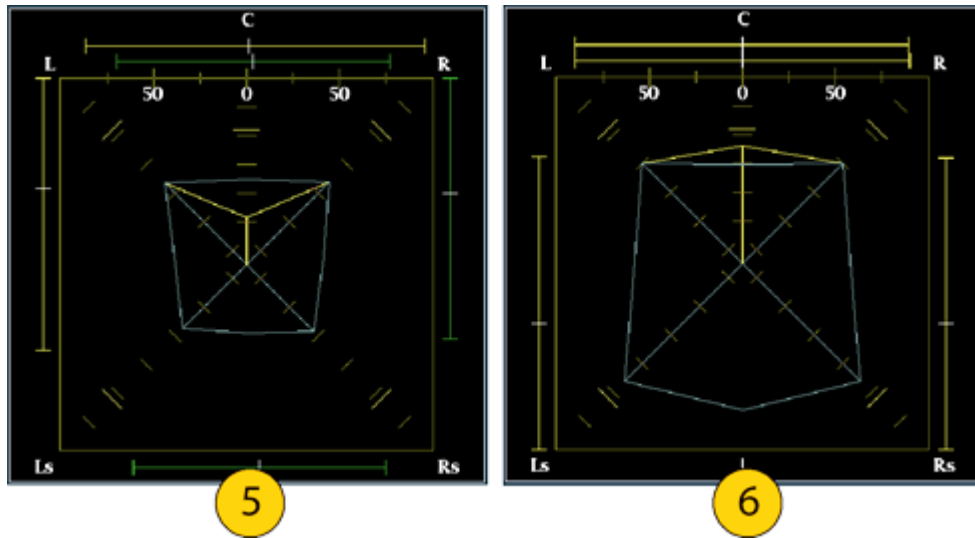

Loudness Meter

It is a part of the Audio App in PRISM and it is configured in the main Settings menu. The Audio Loudness meter allows you to view audio loudness values associated with audio loudness measurements. This instrument maintains a running audio loudness session.

To turn on the audio loudness values, in the Audio Settings, in Aux Display, set Loudness Meter to **On**.

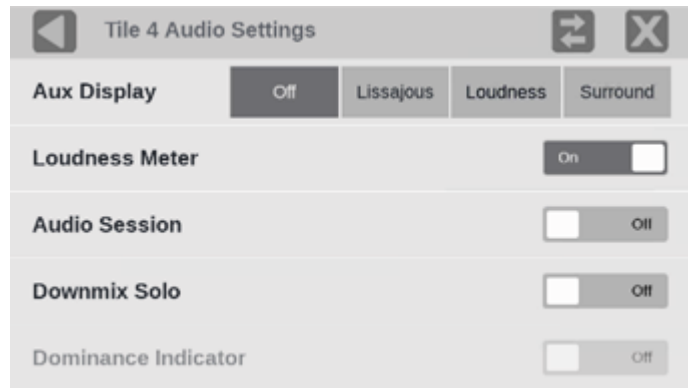

The Loudness Meter appears to the right of the Audio bars.

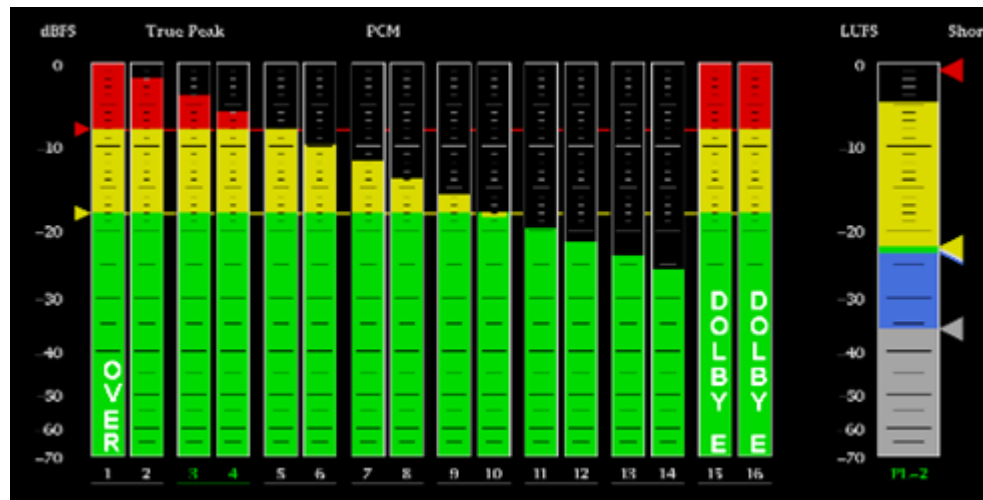

Audio Session

It consists of several performance parameters for an overview of the audio input signal.

To turn on the audio signal overview, in the Audio Settings, set Audio Session to **On**.

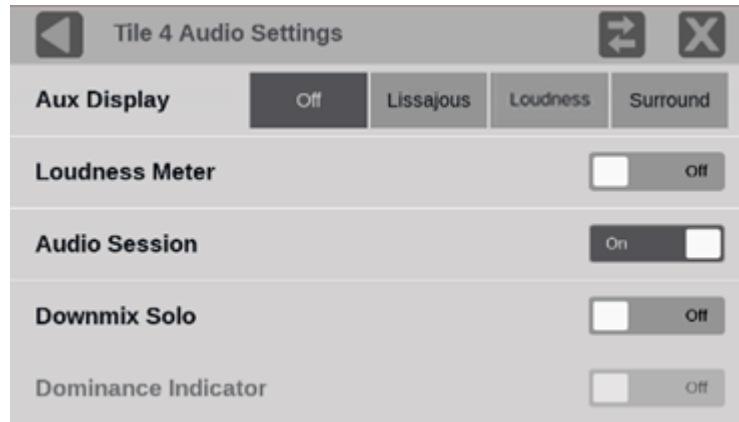

The Audio Session appears below the audio bars.



Downmix Solo

It allows you to select any one channel of a downmixed 5.1 or 7.1 stream and listen to it alone. This helps to isolate and identify an unexpected noise in a stream.

To use Downmix Solo:

1. Set up a 5.1 or 7.1 stream for downmix.

2. To turn on Downmix Solo, in the Audio Settings, set Downmix Solo to **On**.

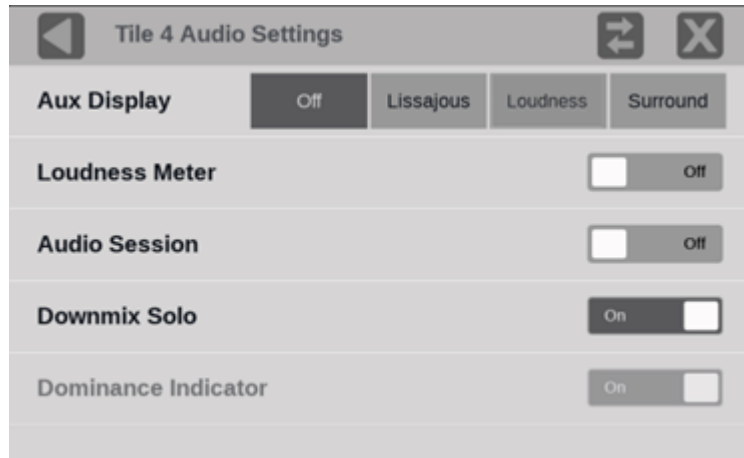

3. Select Volume (🔊) in the Status bar to open the volume controls.

4. In the volume controls, select the downmix button



5. Select the Home icon to close the volume controls.

6. Select a channel to isolate in the Audio application:

- To change the solo channel, select another channel in the downmixed stream.
- To return to the entire downmixed stream (without turning Downmix Solo off), select the highlighted channel again.

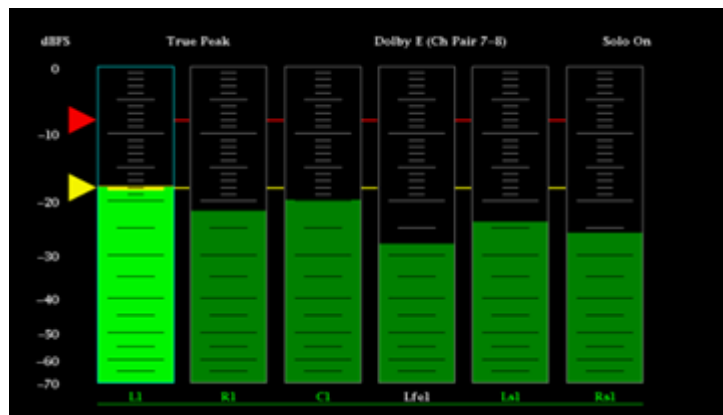

Picture Application

The Picture display lets you see the picture generated by the video signal.



(Copyright 2008, Blender Foundation / www.bigbuckbunny.org)

Picture Settings Menu

Note: The Move icon (📏) is in the settings menu header. Select this icon to move the settings left or right.

Open the Picture Settings menu:

1. Select the **Tiles** icon (🧩).
2. Select the tile with the Waveform application.

3. Select the **Tile** icon (⚙️).

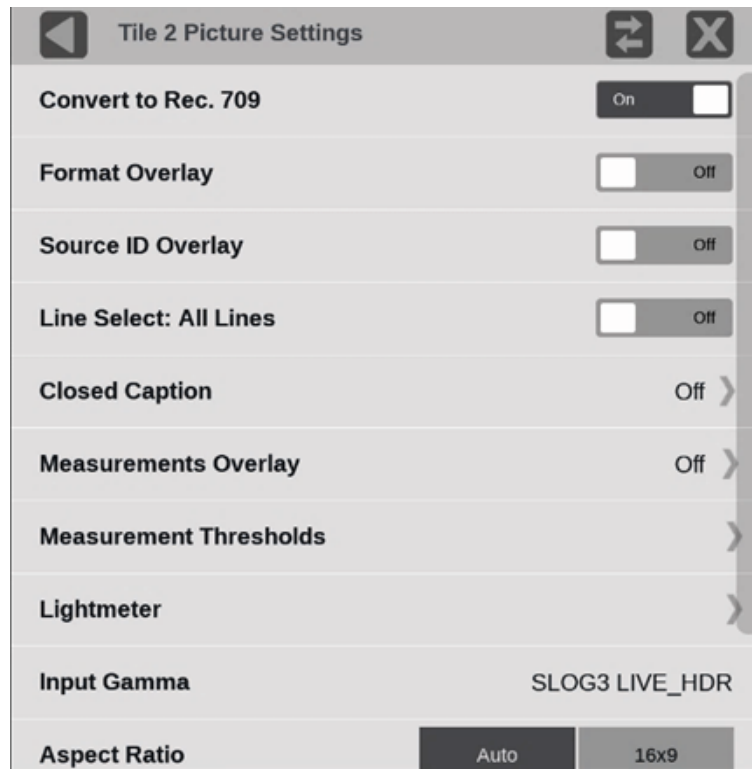

Convert to Rec. 709

Set to **On** to allow the trace displays to convert camera logs to Rec. 709 (requires Option MP2-PROD).

Note: Convert to Rec. 709 mode is not supported for SD signals. In full screen mode, there is no cropping. Pictures are decimated horizontally or vertically to obtain the correct aspect ratio. This decimation may cause some artifacts.

Format Overlay

Set to **On** to display the format information on top of the picture. Select and drag the format information window to set the location.

Source ID Overlay

Provides an overlay of the video source on the Picture application. The source data carries ANC data conforming to SMPTE 291M. The default DID is 0x53 and SDID is 0x49. Set them as required. The source ID is limited to a maximum 15 ASCII characters.

To enable the Source ID Overlay, open the Picture Setting menu and then set the Source ID Overlay to **On**. Select and drag the overlay to the correct location on the application.

Line Select

Allows you to select the picture line to monitor a line in the available trace displays, including Waveform, Stop, Vector, Diamond, Lightning, and CIE. Either All Lines (Line Select is Off) or 1 Line (Line Select is On) can be selected.

If 1 Line is selected then a horizontal line appears on the picture. Select and drag the line to choose a line to monitor. The selected line number is noted on the line.

Closed Caption

Settings for closed captions/subtitles formats and services. See Closed Caption for more information about this feature.

Measurements Overlay

The visibility of the available picture measurements can be adjusted by selecting this menu item. See Picture Measurements for more information about this feature.

Measurement Thresholds

Threshold for the HDR picture measurements are made in this menu. See Picture Measurements for more information about this feature.

Lightmeter

Displays the light level (in nits or stops) at the point marked by the Lightmeter cursor in the Picture display. (See [Configure the Lightmeters.](#))

Input Gamma

Reports the input Gamma set in the Settings menu for the selected input.

False Color

Three false-color displays are available, which apply a color palette to the picture to highlight attributes associated with images.

- Gamut: Used for a quick check of gamut compliance to Rec. 709 and P3 gamut limits.
- % Area: A fixed false-color palette is applied to regions of the picture: Brightest, Area, and Darkest.
- Luminance: Create a user defined false color palette based on luminance values. (See [Luminance False Color.](#))

Closed Caption/Subtitles

Tools for closed captions/subtitles decode and display.

- CC information overlay: Provides closed captions/subtitles format, and service/page and presence.
- CC/Teletext: Selects the closed captions/subtitles format and service.

To turn on the CC Information Overlay:

Select **Closed Caption** from the Picture Settings menu and set the CC Information Overlay to **On**.

The overlay provides closed captions/subtitles format and service information. To move the overlay, select and drag it to the new location.

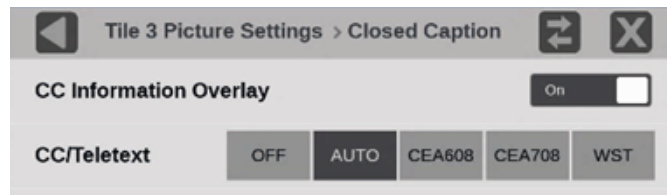

Set the CC/Teletext

Select a format to decode and open the service options.

- OFF: Turns off the closed caption decoding. The overlay remains in the Picture tile if it is on.
- Auto: Detects and selects the closed captions/subtitles format in the signal and presents the service options. Select the appropriate input.
- CEA 608: A standard format of closed captions/subtitles data used in the U.S., Canada, and Mexico for analog TV transmissions. If a service has no activity for 10 seconds, it is considered missing.
- In the CEA608 Channel, select, from 1 to 4, the appropriate input.
- CEA 708: A standard format of closed captions/subtitles data in the U.S. and Canada for digital TV transmissions. If a service has no activity for 10 seconds, it is considered missing.
- In the CEA708 Service, select, from 1 to 6, the appropriate input.
- WST: Also called Teletext, it is a standard format of closed captions/subtitles used in many parts of the world. Support includes OP-47 and 2031.

In Teletext Page, set the page number: Select the up or down arrow, or select the number and use the pop-up keypad, to enter the page number for your region.

Note: Each Picture tile can select a closed caption format and a service.

Picture Measurements

An overlay containing a selectable set of picture measurements can be shown on the picture application, including HDR measurements.

Select and drag the measurement overlay to set the location.



Select Picture Measurements

1. Select the Picture application, and in the Applications menu, select the Tile icon ().
2. Select the **Measurements Overlay** menu item.
3. Set Measurements Overlay to **On**. This turns on the measurements overlay in the Picture application. After it is visible, the overlay window can be dragged to any location in the Picture tile.

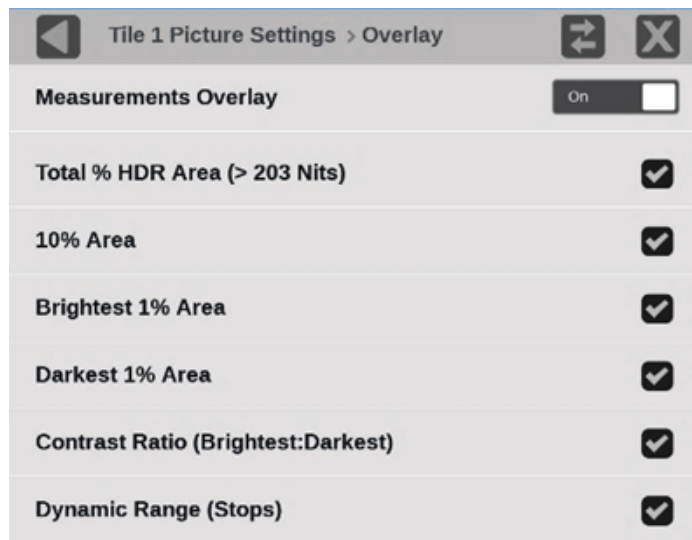

Select the picture measurements to see in the overlay. For many of the parameters a threshold setting is required. See the Measurement Threshold menu for setting these thresholds.

These measurements are available. Settable thresholds are indicated by x:

- Total percent HDR area the Nits threshold for this measurement can be set.
- X percent area, in nits

- Brightest x percent
- area, in Nits
- Darkest x percent Area, in Nits
- Contrast Ratio (Brightest:Darkest)
- Dynamic Range (stops = $\text{Log}_2(\text{Brightest x percent} / \text{Darkest x percent})$).

Picture Measurement Thresholds

To select the thresholds for those picture measurements that require them:

1. Select the Picture app and then, in the applications menu, select the **Tile** icon ().
2. Select the Measurement Thresholds menu item.

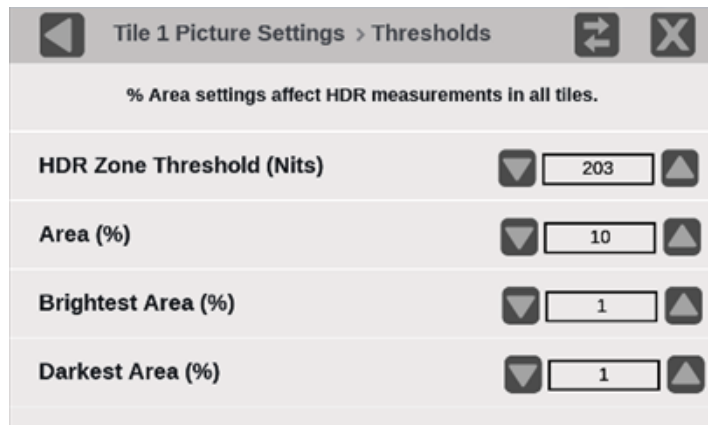

% Area settings affect HDR measurements in all tiles.	
HDR Zone Threshold (Nits)	203
Area (%)	10
Brightest Area (%)	1
Darkest Area (%)	1

The threshold settings:

- HDR Zone Threshold (Nits): Any picture value higher than this threshold, in Nits, is considered in the HDR zone.
- Area (percent): Defines the brightest percentage of the picture used to determine the bright threshold in Nits.
- Brightest Area (percent): Defines the brightest percentage of the picture used to determine the HDR threshold in Nits.
- Darkest Area (percent): Defines the darkest percentage of the picture used to determine the dark threshold in Nits.

Configure the Lightmeters

The Lightmeters measure the light level, in Nits or stops, at the point marked by the Lightmeter cursor in the Picture application. Proper operation requires selecting the appropriate Gamma Curve in the input settings. (See [Choose the Gamma Curve option from the drop-down menu](#). *The selection characterizes the video signal on each virtual input.*)

Note: The readout is the average luminance of a 5x5 pixel area in a 1920x1080 picture, a 10x10 pixel area in a 3840x2160 picture, and a 20x20 pixel area in a 7680x4320 picture.

Turn on or Change the Lightmeters

1. Open the Picture Settings menu and select **Lightmeter**.
2. Set the Lightmeter Overlay to **On**.
3. Select the number of needed Lightmeter cursors (up to 5).

Note: The Lightmeters all use the same method for measurements. The color of the Lightmeter cursor is just for identification.

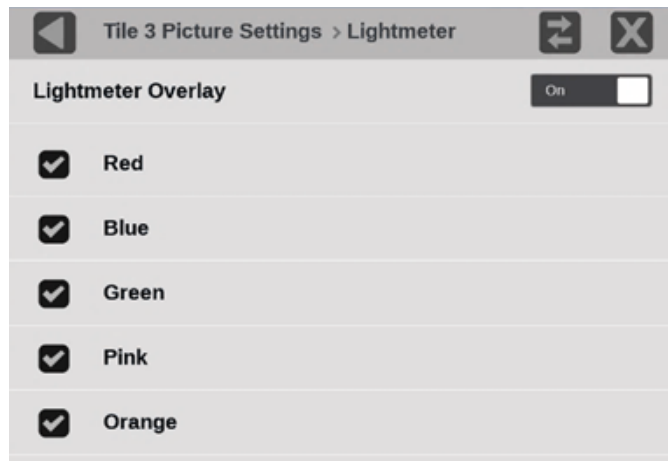

The Lightmeters are visible in the Picture application.

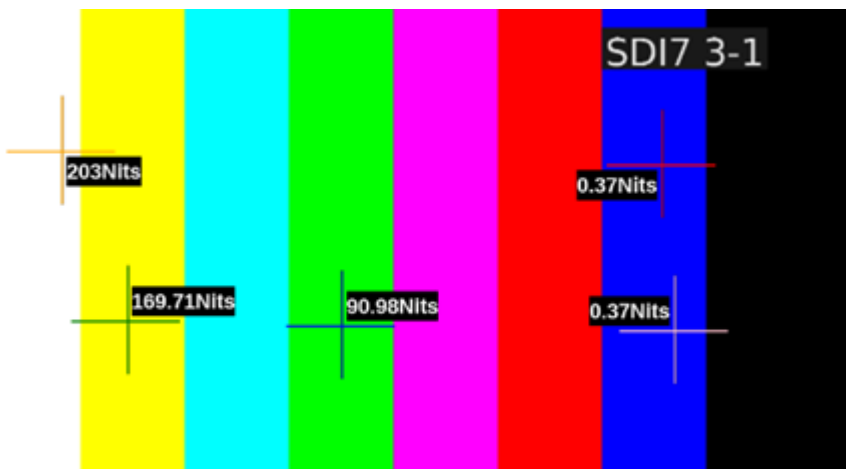

To Adjust the Lightmeters Cursors

- To move the Lightmeter cursors, select any part of the crosshairs or the measurement numbers and drag the target to the new location. The measurement updates automatically.
- To remove a selected Lightmeter cursor from the Picture, unselect the color in the Settings menu.
- To remove all the Lightmeters cursors from the Picture, unselect all of the Lightmeter colors or set the Lightmeter Overlay to Off.

Luminance False Color

The Luminance False Color display replaces pixels that fall within a specified range of nits or stops values to a color that you specify. Up to 9 configurable ranges can be defined. For example, you can use the Luminance False Color display to tag pixels that are within a specified HDR range.

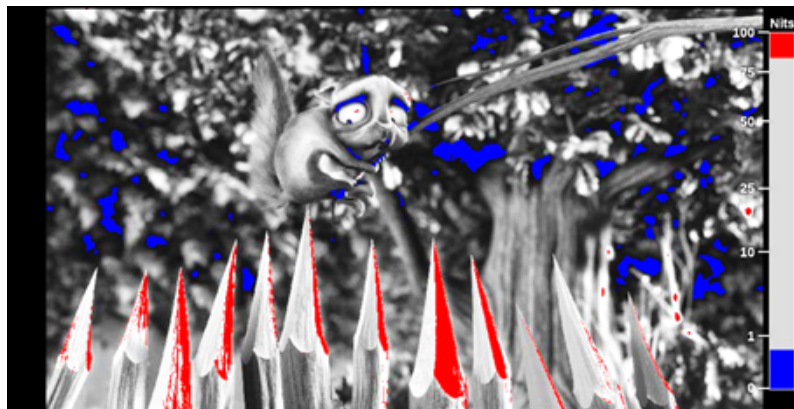

(Copyright 2008, Blender Foundation / www.bigbuckbunny.org)

The false color ranges are defined in nits or stops depending on the gamma curve set up in the input (select Settings and then Input). If a camera-based gamma curve is set, such as S-Log2, the false color ranges are in stops. If a display-based gamma curve is set, such as SDR Narrow, the false color ranges are in Nits.

These controls adjust the Luminance False Color display:

Meter Overlay

Set to On to enable the Meter Overlay in the Picture application. The overlay shows the false color definitions in nits or stops made in the Luminance False Color table at the bottom of the menu. The overlay can be moved to the right, bottom, left, or top of the image by dragging the meter with a mouse or by touch.

Default: By default, the false colors are defined according to the BT.2408 specifications if a display-based gamma curve is set for the input, or a typical camera specification if a camera-based gamma curve is set for the input. If changes are made to the false color

ranges in the Luminance False Color table, an indication that the default settings have changed is shown. Select the Default button to reset the ranges to their default settings.

Luminance False Color Table

The Luminance False Color table allows you to customize up to 9 different false color ranges as defined by a minimum and maximum Nits or Stops value. The pixel values are displayed in either Code Value or Percent but selecting the readout in the table header.

Specific colors can be displayed by selecting the check box in the Enable column of the table. You can change the Nits or Stops range even if the check box is not set.

To adjust the Nits or Stops range, tap anywhere in the row you want to change. You can adjust the Minimum and Maximum value in the range using the up and down arrow keys, or select in the number field and a numeric entry keypad appears. Enter the line number and select Enter to close. The false colors in the Picture and the Meter Overlay are updated as adjustments are made.

If the range for one color overlaps the range for another color, the color that is higher in the table overlaps the colors lower in the table.

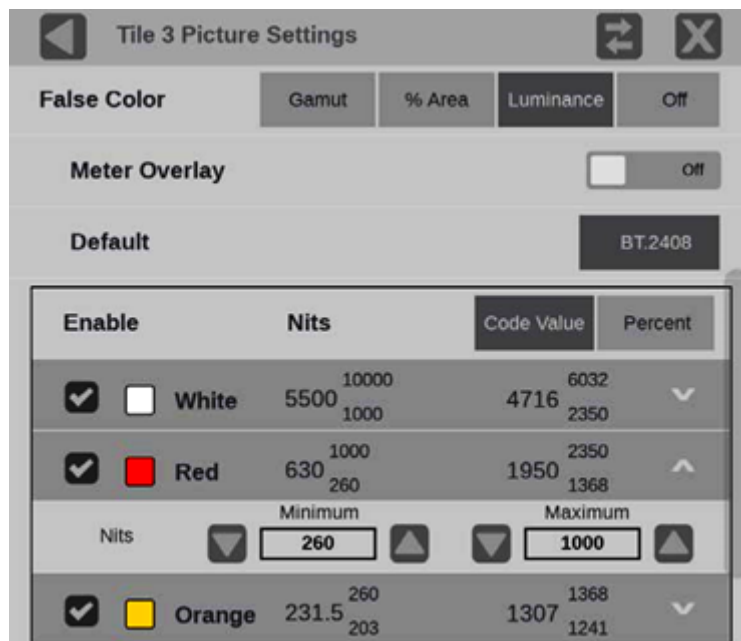

Video Session Application

Use this application to view various performance parameters of the SDI video signal or the decoded IP stream. Select any of the four tab titles to view the associated information: SDI Format, VPID 352, Bit Level, or CRC Status.

The screenshot shows the 'Video Session' application interface. At the top, it displays 'Run Time: 0d, 19:01:08' and a 'Running' status with a stop button. Below this, the input source is identified as 'SDI - SDI-In 1' with a sample rate of '1080i 59.94' and a transport rate of 'HD SDI 422 - 292M 1.485/M Gbps'. There are four tabs: 'SDI FORMAT', 'VPID 352', 'BIT LEVEL', and 'CRC STATUS'. The 'CRC STATUS' tab is currently selected and highlighted. Below the tabs is a table with the following data:

STATISTICS	STATUS	ERR FIELDS	ERR SECS	% ERR FIELDS
Y Chan CRC Error	OK	1719	746	0.0419
C Chan CRC Error	OK	1719	746	0.0419
Y Anc Checksum Error	OK	89	5	0.0022
C Anc Checksum Error	OK	215	6	0.0052

Elements of the Video Session Display

The elements at the top of the Video Session application:

- **INPUT:** Shows the selected input source on the top line and shows the detected format, sample structure, and transport of the input signal on the second line.
- **Display tabs:** Click one of the four tabs to view the associated display. Each of the tabs has a status indicator to provide a quick view of the status of the parameters contained in each tab.
 - **SDI FORMAT:** Use this tab to view the status of various SDI signal parameters on the input signal.
 - **VPID 352:** Use this tab to view the status of the SMPTE352M VPID on the input signal. For 3G-SDI signals, VPID is required on the primary link (Link A).
 - **BIT LEVEL:** Use this tab to view if there are any stuck bits in the input signal.
 - **CRC STATUS:** Use this tab to view the status of CRC and Checksum errors in the video signal.
- **Run Time:** The instrument maintains a running monitoring session for the Video Session application. The Run Time readout displays the amount of time that has elapsed during the current monitoring session. The time is displayed as DD, HH:MM:SS. DD is the number of days, HH is the number of hours, MM is the number of minutes, and SS is the number of seconds.
- **Reset icon:** Select the Reset icon (🔄) to restart the monitoring session.

- Run / Stop icons: When the monitoring session is running (collecting error data), select the Stop icon (◻) to stop the session. When the monitoring session is stopped (no error data collection and no display updates), select the Play icon (▶) to restart the session.

SDI FORMAT Tab Display

Use the SDI FORMAT tab display to view the status of various SDI signal parameters on the input signal.

Elements of the SDI FORMAT tab display

- SAV Place Err: Indicates whether a Start-of-Active-Video Placement error has occurred.
- EAV Place Err: Indicates whether an End-of-Active-Video Placement error has occurred.
- Field Length Err: Indicates whether a Field Length error has occurred.
- Line Length Err: Indicates whether a Line Length error has occurred.
- Line Number Err: Indicates whether a Line Number error has occurred.
- Ancillary Data: Indicates whether Ancillary Data is present in the video signal. The displayed values are either Present or None for SD signals, or Y and C Present and None for HD and 3 Gb/s signals.
- Statistics: This section of the display shows the status and statistical values for certain errors. For information about the errors in this section, view the help file in your instrument: When the Video Session is active in a tile, select the HELP button.
- Status: Shows the status of the associated error as either OK, Invalid, Missing, or Error.

VPID 352 Tab Display

Use the VPID 352 tab display to view the VPID values of the SMPTE352M payload. For 3G-SDI signals, VPID is required on the primary link (Link A).

SDI FORMAT	VPID 352	BIT LEVEL	CRC STATUS
Link A1	8Ah 4Ah 40h 1h	BYTE 1 10001010	SMPTE 425.1 Lvl B (1125)
Link A2	8Ah 4Ah 40h 41h	BYTE 2 01001010	Transport interlaced
			Picture progressive
			Transfer SDR
			Picture Rate 59.940
		BYTE 3 01000000	Aspect Ratio Unknown
			H pixel 2048
			Color BT709
			Sampling Structure YCbCr 4:2:2
		BYTE 4 00000001	Luma Color Difference YCbCr
			Channel assignment 1
			Bit Depth 10-bit

The VPID 352 tab consists of two panes:

- Left pane: Indicates the presence of a SMPTE 352M payload. The number of data streams determines the number of links, with the VPID values shown in hex. You may select a link to display the decoded VPID information in the right pane.
- Right pane: Contains the decoded VPID of the selected link.

BIT LEVEL Tab Display

Use the BIT LEVEL tab display to view if there are any stuck bits in the input signal.

SDI FORMAT	VPID 352	BIT LEVEL	CRC STATUS
Link A1: C Stuck Bits		-----LL	
Link A1: Y Stuck Bits		-----LL	

Elements of the BIT LEVEL Tab Display

- Y Stuck Bits: Displays which of the luminance video bits are stuck. If the readout is " ---", then none of the bits are stuck.

Note: For 8bit video, since the unused bits are always low, "----LL" is displayed when no other bits are stuck.

- C Stuck Bits: Displays which of the Chrominance video bits are stuck. If the readout is "---", then none of the bits are stuck.

CRC STATUS Tab Display

Use the CRC STATUS tab display to view the status of CRC and Checksum errors in the video signal.

STATISTICS	STATUS	ERR FIELDS	ERR SECS	% ERR FIELDS
Y Chan CRC Error	OK	2	1	0
C Chan CRC Error	OK	2	1	0
Y Anc Checksum Error	OK	0	0	0
C Anc Checksum Error	OK	0	0	0

Elements of the CRC STATUS tab display

Note: The instrument uses the SMPTE RP165 standard for error checking. For HD and 3 Gb/s signals, the CRCs change on every video line.

- Y Chan CRC Error: Displays the status of the Y channel embedded CRC (Cyclical Redundancy Check) that was calculated for the video signal. Using a known test signal, the CRC status can be used to verify integrity through a system. An error means that the Y Channel embedded CRC value does not match the calculated CRC value, which indicates that a transmission error has occurred.
- C Chan CRC Error: Displays the status of the C channel embedded CRC (Cyclical Redundancy Check) that was calculated for the video signal. Using a known test signal, the CRC status can be used to verify integrity through a system. An error means that the C Channel embedded CRC value does not match the calculated CRC value, which indicates that a transmission error has occurred.
- Y Anc Checksum Error: Displays the status of the Y channel ancillary embedded checksum value that was calculated for the video signal. Using a known test signal, the checksum status can be used to verify integrity through a system. An error means that the Y Channel embedded checksum value does not match the calculated checksum value, which indicates that a transmission error has occurred.
- C Anc Checksum Error: Displays the status of the C channel ancillary embedded checksum value that was calculated for the video signal. Using a known test signal, the checksum status can be used to verify integrity through a system. An error

means that the C Channel embedded checksum value does not match the calculated checksum value, which indicates that a transmission error has occurred.

The CRC Status display is also divided into four columns:

- Status: Shows the status of the associated error:
 - OK: No error is currently detected.
 - Invalid: The data for the item is currently invalid.
 - Missing: The data for the item is currently missing.
 - Error: The associated error is currently in an error state.
- Err Fields: The number of fields, since the last reset, that contained at least one error.
- Err Secs: The number of seconds, since the last reset, that contained at least one error.
- % Err Fields: Shows a calculated number showing the percentage of all fields since the last reset that contained at least one error.

Timing Application

The Timing application uses a reference to evaluate the timing of the input of single-link SDI, quad-link SDI, or IP formats (ST2022-6 or ST2110-20). The timing of the input is compared to the expected frame time according to the reference alignment.

SDI versus Black Burst is available in standard. SDI versus PTP, IP versus PTP, Black Burst versus PTP requires Option MP2-IP-MEAS.

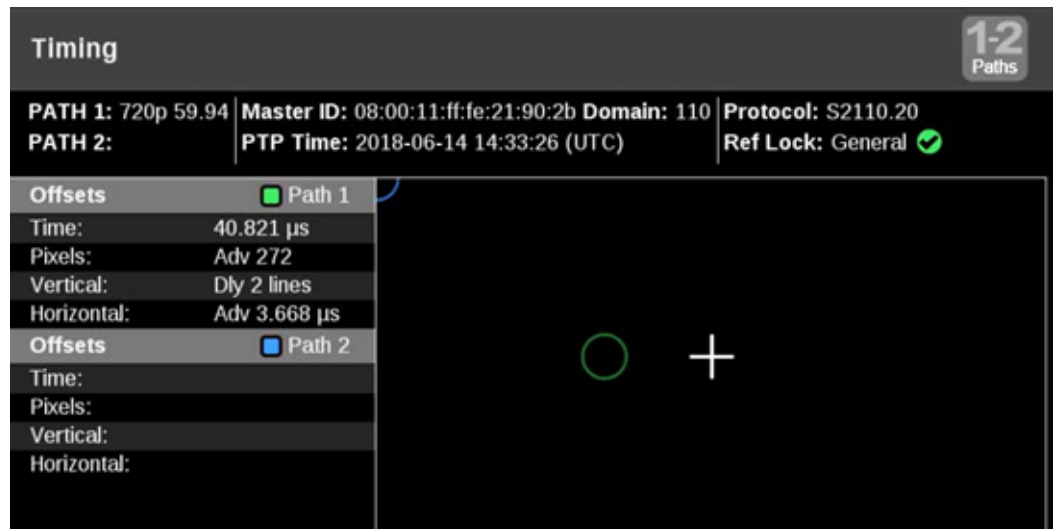

For analog references (Black Burst or Tri-Level sync) the relative position of the horizontal and vertical sync pulses are compared to the input signal. In the case of PTP the current time is obtained and compared to the SMPTE Epoch. When an input is configured for ST2022-7 style redundant streams, circles for Path 1 (green) and Path 2 (blue) appears, otherwise only a single path displays. When the input signal is fully aligned with the reference, both circles are in the center of the display indicated by the + symbol.

Note: PTP must be locked to use the Timing application with PTP references.



Timing Settings Menu

Open the Picture Settings menu:

1. Select the **Tiles** icon ().
2. Select the tile with the Picture application.
3. Select the Tile icon ().

Measurement Mode

Use the menu to change the measurement mode between options.



- Video to Reference: The input video signal (SDI or IP) is compared relative to the reference input (analog or PTP).
- Analog to PTP: Used in a hybrid system to compare the analog reference to the PTP reference to ensure synchronization.



Elements of the Timing Display

- Path 1 and Path 2: Displays the IP video format if an IP input signal is selected.

Note: You can switch between Path 1, Path 2, or both Path 1-2 using the Path button at the top right of the application display.

- Master ID and Domain: Displays the reference Source and Domain.
- PTP Time: Time of day derived from the PTP signals.
- Protocol: Displays the input protocol.
- Ref Lock: A  (check in green) indicates the PRISM is locked to the reference. A  (x in red) indicates the PRISM is not locked to the reference.
- Reference Indicator: A cross-hair indicator centered in the display represents the reference signal.
- Circle: The circle represents the timing of the input signal. A signal that is early is above or to the left of the cross hair. A signal that is late is below or to the right.
- Offsets: The difference in timing between the input and reference. A positive number, or "delayed" value, means the input occurs after the reference. A negative number, or "advanced" value, means the input occurs before the reference.
 - Time: The total difference in frame timing between the input and reference
 - Pixels: The timing difference between the reference and input signal, expressed as in pixels, instead of time units, after the vertical offset has been removed. This has a range of $\pm \frac{1}{2}$ line for the input format.
 - Vertical Offset: The timing difference between the reference and input signal, expressed as the number of lines of delay for the input video format. This has a range of $\pm \frac{1}{2}$ field for progressive signals and $\pm \frac{1}{2}$ frame for interlace signals.
 - Horizontal Offset: The timing difference between the reference and input signal, expressed as the line time which remains from the total delay after the vertical offset has been removed. This has a range of $\pm \frac{1}{2}$ a line for the input format.

Additional offset displays are available for Quad Link SDI signals.

- Link Offsets: Time delays of Links B, C, and D relative to Link A. These time delays are also shown graphically under the timing display window.
- Max Link Offset: Maximum time delay between any two links.

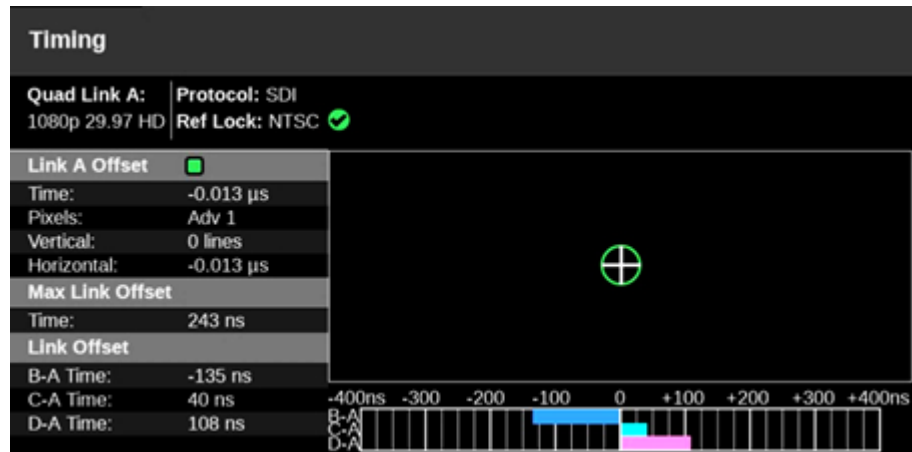

Timing Offsets for IP Signals

Because ST2022-6 streams are complete SDI signals encapsulated in IP, the timing measurement treats these IP signals as if they were SDI. So the timing system detects the start of the IP frame, then extrapolates to the 0h point of the encapsulated SDI. Then using PTP as the reference, the ideal alignment point for that frame rate is calculated based on the PTP epoch. Finally, the offset between the ST2022-6 signal and the ideal alignment is displayed. The display shows both absolute time and the time parsed into lines or horizontal delay as time and pixels.

For ST2110-20 streams, the Timing application displays the time of the first packet of the frame. Since ST2110 does not include blanking, the first packet is nominally coincident with the first active line in the SDI raster. This means it is normal for the ST2110 streams to be delayed by the lines in the vertical blanking of a given format. This value varies by format: HD (21 lines), 3G (42 lines), 4K/UHD (84 lines). According to ST2110-21, both gapped and linear flows should have the start of frame delayed by the equivalent of vertical blanking.

Use Cases for Measuring Timing

One use case for the Timing application is to measure the delay in a gateway and network. If a properly timed SDI signal is applied to a gateway, then the timing measurement on the resulting IP flow displays the combined latency in the gateway and the network.

Each ST2110 stream also carries time stamps. The Stream Timing application allows for the analysis of these time stamps.

Event Log Application

The Event Log application provides a view of detected errors. The display buffer for the application shows 1,000 log entries.

Group	Event	Input	Notes	TC (LTC)	Date	Time
Timing	Timing drift	SDI-In 2	Timing Drift: SDI 2	00:00:00.0	2021-01-31	02:44:11
Timing	Timing drift	SDI-In 2	OK	00:00:00.0	2021-01-31	02:44:30
Timing	Timing drift	SDI-SFP+ 2	Timing Drift: IP SFP+ 1	00:00:00.0	2021-02-01	12:10:19
Timing	Timing drift	SDI-SFP+ 1	OK	00:00:00.0	2021-02-01	14:27:59
Timing	Timing drift	SDI-SFP+ 2	Timing Drift: IP SFP+ 1	00:00:00.0	2021-02-01	14:43:21
Timing	Timing drift	SDI-SFP+ 1	OK	00:00:00.0	2021-02-01	14:54:59
Timing	Timing drift	SDI-SFP+ 2	Timing Drift: IP SFP+ 1	00:00:00.0	2021-02-01	15:04:40
Timing	Timing drift	SDI-SFP+ 1	OK	00:00:00.0	2021-02-01	15:17:28
Timing	Timing drift	SDI-In 2	Timing Drift: SDI 2	00:00:00.0	2021-02-02	13:25:39
Timing	Timing drift	SDI-In 1	OK	00:00:00.0	2021-02-02	13:25:58
Timing	Timing drift	SDI-In 4	Timing Drift: SDI 4	00:00:00.0	2021-02-02	13:26:14

Elements of the Event Log Display

- **Reset icon:** Select the Reset icon (↺) to hide all log items, so only new log items are displayed. Select **Undo Reset** in the settings menu to show the log items that were hidden by pressing Reset.
- **Track icon:** The Track icon (⏮) and the text “Tracking” to the left mean the Event Log is tracking new events. The newest events appear at the bottom of the Event Log.

Group	Event	TC (LTC)	Date	Time
Audio	Audio Over error	22:57:36:17 (LTC)	2021-02-24	15:09:01
Audio	Audio Over error	22:57:37:22 (LTC)	2021-02-24	15:09:02

Scroll in the Event Log list or select-and-hold the slider and move to a previous event. Tracking new events is automatically paused.

- Pause icon: The Pause icon (⏸) and the text “Paused” means the Event Log is not tracking new events. Select the Pause icon to return to tracking new events. The Error Log is also divided into four columns:



The Error Log is divided into columns:

- Group: Lists the group the event is related to and shows the current state of the log entries:
 - Red-rising edge (↗) items are detected errors.
 - Green-falling edge (↘) items are errors that have cleared.
 - Red and green- rising and falling edge (⏏) items indicate a momentary error that was in error condition but is now in normal condition. The PTP or TC field is blank when the selected time source is not available.
 - White items are informational and identify a change in instrument state.
- Event: Lists the title of the error.
- PTP (UTC) or TC (LTC): Shows the time, in the mode chosen by the user, the error occurred.
- Date: Shows the date, according to the internal clock, that the error occurred in the form YYYY-MM-DD.
- Time: Shows the time, according to the internal clock, that the error occurred in the form HH:MM:SS.

Event Log Settings Menu

Note: The Move icon (↔) is in the settings menu header. Select this icon to move the settings left of right.

Open the Event Log Settings menu:

1. Select the **Tiles** icon (⏏).
2. Select the tile with the Event Log application.

3. Select the **Tile** icon (⚙️).

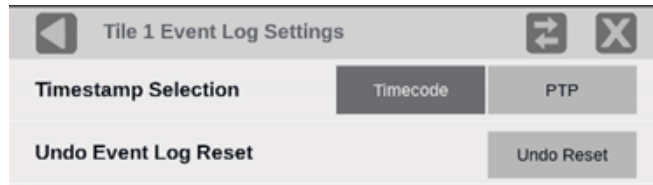

Timestamp Selection

- Select **Timecode** to set TC (LTC) or TC (VITC) for error tracking in the Event Log.

Configure TC (LTC) or TC (VITC) in Settings menu (⚙️), in Anc Data, in Timecode Format.

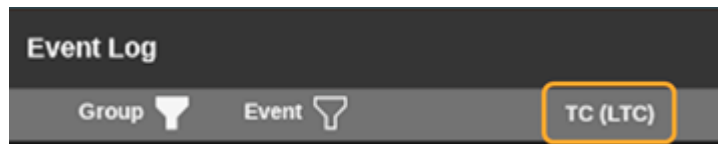

- Select **PTP** to set PTP (UTC) for error tracking in the Event Log.

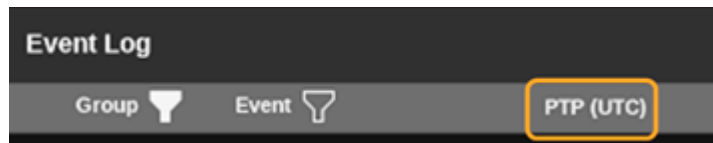

Undo Event Log Reset

Select **Undo Reset** to cancel the last reset of the logged events.

Filter Event Log Events

Filter by Group

- To open the group filter, select the Group heading.

Note: If there is any other filter applied (Event, Date, Time—marked by a full filter icon (🔍) next to a heading), it limits what any other filter shows. For example, if no events

are selected in the Event filter, then no errors appear even if all the groups are selected.



- To move the menu to a location, select and hold anywhere in the menu.
- To select all checkboxes (see all errors), or unselect all (hide all errors), select **All Groups**. The Event Log immediately adds or removes errors from the list.
 - If all groups are selected (no filter), the Group filter icon is empty.

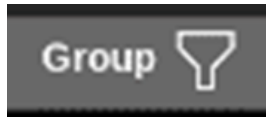

- If any group is not selected (a filter is applied), the Group filter icon is full.

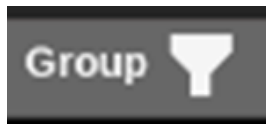

- To select or unselect any single checkbox, select anywhere in the line of the title.

Filter by Event

- To open the event filter, select the Event heading.

Note: If there is any other filter applied (Group, Date, Time—marked by a filled filter icon——next to a tile), it limits what any other filter shows. For example, if no groups

are selected in the Group filter, then no errors appear even if all the events are selected.



- To move the menu to a location, select and hold anywhere in the menu.
- To select all checkboxes (to see all errors), or unselect all (to hide all errors), select **All Events**. The Event Log immediately adds or removes errors from the list.
 - If all groups are selected (no filter), the filter icon is empty.



- If any group is not selected (a filter is applied), the filter icon is full.



- To select or unselect any single checkbox, select anywhere in the line of the title.
- To scroll through the list of events, select the arrows at the top and bottom of the menu.

Filter by Date or Time

- To open the Date and Time filter, select either the Date or Time heading. Both open the same menu.

Note: If there is any other filter applied (Group, Event—marked by a filled filter icon——next to a tile), it limits what any other filter shows. For example, if no groups are selected in the Group filter, then no errors appear even if all the events are selected.

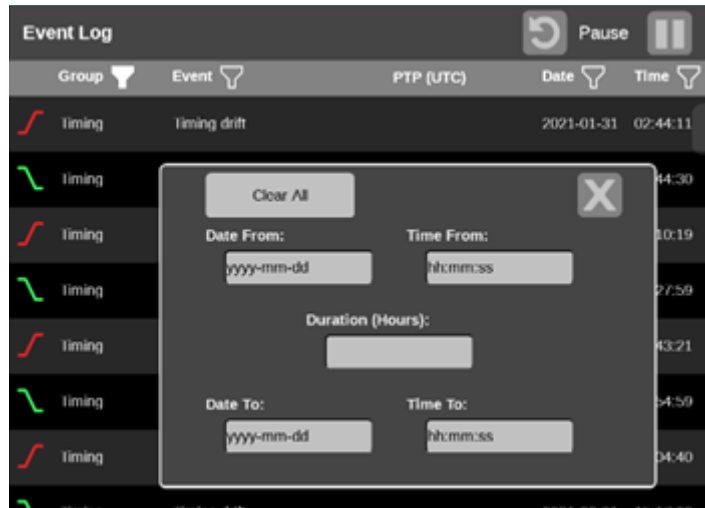

- To move the menu to a location, drag anywhere on the screen.
- To enter a filter date:
 - Select in the Date From field and either enter a date (yyyy-mm-dd) with a keyboard, or select the date using the on-screen Adjust Date tool.
 - Repeat selecting a date in the Date To field, if needed.

Note: Other filters (duration, time) are not required.

The screenshot shows a filter configuration window with a dark background. At the top left is a 'Clear All' button and a close 'X' button. Below are two rows of input fields: 'Date From:' with a text box containing '2021-03-11' and 'Time From:' with a text box containing 'hh:mm:ss'. Below these is a 'Duration (Hours):' text box. The next row contains 'Date To:' with a text box containing 'yyyy-mm-dd' and 'Time To:' with a text box containing 'hh:mm:ss'. At the bottom is an 'Adjust Date From: Date (Y-M-D)' keypad with a close 'X' button. The keypad has three columns of up/down arrows and three input boxes containing '2021', '2', and '11'. A 'Set' button is at the bottom center.

- To enter a filter time:
 - Select in the Time From field and either enter a time (hh-mm-ss) with a keyboard—or select the time using the on-screen Adjust Time tool—and select **Enter**.
 - Repeat selecting a time in the Time To field, if needed.

Note: Other filters (duration, date) are not required.

The screenshot shows the same filter configuration window. The 'Time From:' field is now highlighted with a red border and contains 'hh:mm:ss'. The 'Duration (Hours):' field contains '10'. The 'Adjust Time From: Time (H:M:S)' keypad is now visible at the bottom, with a close 'X' button. The keypad has three columns of up/down arrows and three input boxes containing '15', '56', and '12'. An 'Enter' button is to the right of the keypad.

- To enter a duration filter, select in the Duration field and enter hours with a keyboard, or use the on-screen keypad, and select **Enter**.

Note: Other filters (date, time) are not required.



- If no date, duration, or time filter is entered (no filter), the filter icon is open.



- If a date, duration, or time filter is entered (a filter is applied), the filter icon is filled.



IP Status Application

The IP Status application provides an overview of the monitored IP stream and shows the status of each program in the stream. After the input signals have been subscribed to using the input settings menu, the traffic on the SFP ports can be viewed using the IP Status application. Depending on the network switch deployed, the traffic may not appear in the IP Status application immediately.

ID	PORT	PROTOCOL	BITRATE	PAYLD	DEST IP	SOURCE
9	1	S2022.6	3.118 Gb/s	98	229.1.1.2:50000	192
10	1	S2110.20	0b/s	96	229.20.1.12:50011	192
11	1	S2110.30	0b/s	97	229.30.1.12:50012	192
12	1	S2110.30	0b/s	97	229.30.1.12:50011	192
13	1	S2110.40	0b/s	100	229.40.1.12:50011	192

View Port 1 and Port 2

Note: The Move icon (↔) is in the settings menu header. Select this icon to move the settings left of right.

Open the IP Status Settings menu:

1. Select the **Tiles** icon (🧩).
2. Select the tile with the IP Status application.
3. Select the **Tile** icon (⚙️).

In the IP Status settings menu select **Both** to monitor both Port 1 and Port 2.





SELECT PORT TO MONITOR	
10/25GE Port 1	<input type="radio"/>
10/25GE Port 2	<input type="radio"/>
Both	<input checked="" type="radio"/>

With both ports selected there are two traffic bars that show the amount of traffic on each port and a traffic table with a Port column.

- The active monitored streams are always displayed at the top of the list.
- The columns are sortable.
- The selected input is now highlighted in the ID column.
- When the row has a yellow gradient, it indicates a signal that was present and is now gone. Select the reset button at the right side of the banner (at the top) to clear the signals that are no longer there.

ID	PORT	PROTOCOL	BITRATE	PAYLD	DEST IP	SO
9	1	S2022.6	3.118 Gb/s	98	229.1.1.2:50000	192
10	1	S2110.20	0b/s	96	229.20.1.12:50011	192
11	1	S2110.30	0b/s	97	229.30.1.12:50012	192
12	1	S2110.30	0b/s	97	229.30.1.12:50011	192
13	1	S2110.40	0b/s	100	229.40.1.12:50011	192

Status Indicators

-  Indicates that the signal parameter has not been in an error condition.
-  Indicates that the signal parameter was in an error condition but the error has now cleared.
-  Indicates that the signal parameter is currently in an error condition.
-  Indicates that the signal parameter is not being monitored for an error condition.

Elements of the IP Status Display

- Port 1 and Port 2: Status of Port 1 and Port 2.
- Total: Shows the total bit rate of the video in the IP stream.
- IP stream bandwidth bar: The blue bar outline at the top of the display represents the total bandwidth of the 10 GE pipe (10.3125 Gb/s). The blue bars inside the outline show the relative bandwidth size of items in the IP stream compared to the total available bandwidth of the stream. Numbers inside the blue bars correspond to the ID numbers listed in the display.
- Run Time: The instrument maintains a running IP Status Session. The Run Time readout displays the amount of time that has elapsed during the current IP Status Session. The time is displayed as "DD, HH:MM:SS", where DD is the number of days, HH is the number of hours, MM is the number of minutes, and SS is the number of seconds.
- Clear icon: Select the Clear icon () to reset the status session. After a reset, items appear in the list in the order they are detected.

- **Yellow gradient:** When an item in the list has a yellow gradient, it indicates the item was previously detected in the stream but is no longer present. The yellow gradient can also indicate messages, which occur only for a few seconds.

Select the Clear icon (✕) to reset the display to view only the items currently in the stream.

- **Green gradient:** When an item in the list has a green gradient, it indicates the item is a currently monitored stream.

Select the Clear icon (✕) to reset the display to view only the items currently in the stream.

The IP Status application is also divided into these columns:

- **ID:** Shows the ID number of each item in the IP stream. The ID numbers correspond to the numbers in the blue bar at the top of the display.
- **PORT:** Shows the Port number being monitored.
- **PROTOCOL:** Shows the protocol being used by each item in the IP stream.
- **BITRATE:** Shows the bitrate of each item in the IP stream.
- **PAYLD:** Shows the RTP Payload Type number of each IP stream.
- **DEST IP:** Shows the destination IP address and port number of the monitored stream in the format <destination IP address>:<port number>.
- **SOURCE IP:** Shows the source IP address and port number of the monitored stream in the form <source IP address>:<port number>.
- **DEST MAC:** Shows the destination MAC address of the monitored stream.
- **SOURCE MAC:** Shows the destination MAC address of the monitored stream.
- **PTP DOM:** Shows the PTP domain of the monitored stream.
- **SEQ ERR:** Shows the number of sequencing errors in the monitored stream.
- **RTP CLK:** Shows the RTP clock of the monitored stream.
- **RTP MARK:** Shows the RTP marker frequency of the monitored stream.

IP Session Application

The IP Session application uses several tabs to display status of various IP stream parameters. Select any of the tab titles to view the associated information: Layer 1/2, Video, Audio, Data, PTP, or NMOS.

Note: Option MP2-IP-MEAS must be installed to use the IP Session application. The display shows only Path 1 unless you enable ST2022-7 Seamless Switching (see [Configure Instrument for HDR/WCG Monitoring](#)). There is a difference between “Port” and “Path”. The Port is the physical SFP port that is used to input the IP signal. Path 1 and Path 2 are the signal paths to be used for seamless switching. This differentiation is being made since it is possible for both Path 1 and Path 2 to use a single Port.

The screenshot shows the IP Session application interface. At the top, it displays 'IP Session' and 'Run Time: 0d, 15:11:29'. There are several status tabs: LAYER 1/2 (checked), VIDEO (checked), AUDIO-1 (checked), DATA (checked), PTP (checked), and NMOS. Below the tabs, there are sections for LAYER 1 (PORT 1 and PORT 2) and LAYER 2 (STATUS and ERR SECS for PATH 1 and PATH 2). The LAYER 2 METRICS section provides detailed data for both paths.

LAYER 1		PORT 1		PORT 2	
✓	25GbE Link	OK		OK	
	SFP Loss Of Signal (LOS)	OK		OK	
LAYER 2		PATH 1		PATH 2	
		STATUS	ERR SECS	STATUS	ERR SECS
✓	Lock	OK	6	OK	6
✓	CRC Error	OK	0	OK	0
LAYER 2 METRICS		PATH 1		PATH 2	
	Rx Bytes	7,616,937,904,320		7,418,943,349,696	
	Rx BER High	0		0	
	Rx CRC Errors	0		0	
	Rx Frames Ok	5,809,973,672		5,674,135,783	
	Rx Frames Errored	0		0	
	Rx Undersize Packets	0		0	
	Rx Oversize Packets	0		0	
	Tx Bytes	8,950,951,217,367		1,143,995	
	Tx Frames Ok	6,745,804,060		12,989	
	Tx Frames Errored	0		0	

Elements of the IP Session Header

The elements at the top of the IP Session application are shared between several tabs:

- Display tabs: Select one of the tabs to view the associated display. Each of the tabs has a status indicator to provide a quick view of the status of the parameters contained in each tab.
 - Layer 1/2: Select this tab to view the status of various signal parameters in the physical and link layers.
 - Video: Select this tab to view the status of the video in the stream.
 - Audio: Select this tab to view the status of the audio in the stream.
 - Data: Select this tab to view the status of the data in the stream.
 - PTP: Select this tab to view PTP parameters.
 - NMOS: Select this tab to view information on the registration server and the last Session Description Protocol (SDP) files received.
- Run Time: The instrument maintains a running monitoring session for the IP Session application. The Run Time readout displays the amount of time that has elapsed during the current monitoring session. The time is displayed as "DD, HH:MM:SS", where DD is the number of days, HH is the number of hours, MM is the number of minutes, and SS is the number of seconds.
- Clear icon: Select the Clear icon (⌫) to reset the monitoring session.
- Running / Stopped icons: When the monitoring session is running (collecting error data), select the Stop icon (⏹) to stop the session. When the session is stopped (no error data collection and no display updates), select the Play icon (▶) to restart the session.

LAYER 1/2 Tab Display

Select the LAYER 1/2 tab to view the status of these signal parameters.

IP Session		Run Time: 0d, 02:01:23		Running <input type="checkbox"/>	
LAYER 1/2	VIDEO	AUDIO	DATA	PTP	NMOS
✓	✓	✓	✓	✓	
LAYER 1		PORT 1		PORT 2	
10GbE Link		OK		OK	
SFP Loss Of Signal (LOS)		OK		OK	
LAYER 2		PATH 1		PATH 2	
		STATUS	ERR SECS	STATUS	ERR SECS
✓	Lock	OK	0	OK	0
✓	CRC Error	OK	0	OK	0
LAYER 2 METRICS		PATH 1		PATH 2	
Rx Bytes		1,011,850,536,954		1,015,520,405,677	

- Layer 1
 - 10GbE Link: Shows the status of the link connection.
Disconnected: No SFP module present.
No Signal: No input signal detected.
OK: Locked to input signal.
 - SFP Loss of Signal (LOS)
Disconnected: No SFP module present.
OK: Locked to input signal.

Note: Functionality of this signal varies depending on the brand of SFP installed. The signal is intended as a preliminary indication that the received signal strength is below a range specified by the SFP vendor. Such an indication typically points to non-installed cables, broken cables, or a disabled, failing or a powered off transmitter at the far end of the cable.

- Layer 2
 - Lock: Shows the lock status of the link:
OK: The 10G Ethernet Phy Rx port is successfully locked to the inbound Ethernet signal.
ERROR: The 10G Ethernet Phy Rx port lost lock to the incoming Ethernet signal during the last second. This indicates there is likely a physical layer problem with the link.
 - CRC Error columns:
STATUS: There have been no overflow errors in the Ethernet MAC during the last second.
ERR SECS: An errored second is an interval of a second during which any error has occurred, regardless of whether that error was a single bit error, or a complete loss of communication for that entire second.

- Layer 2 Metrics:
 - Rx Bytes: A count of the number of bytes received.
 - Rx BER High: Indicates that the Sync Header BER is greater than 10⁻⁴.
 - Rx CRC Errors: A count of the number of CRC errors detected.
 - Rx Frames Ok: A count of the number of Ethernet frames received without error.
 - Rx Frames Errored: A count of the number of Ethernet frames received with errors detected.
 - Rx Undersize Packets: A count of the number of Ethernet frames received that are less than 64 bytes long.
 - Rx Oversize Packets: A count of the number of Ethernet frames received that are greater than 1522 bytes long.
 - Tx Bytes: A count of the number of bytes transmitted.
 - Tx Frames Ok: A count of the number of Ethernet frames transmitted without error.
 - Tx Frames Errored: A count of the number of Ethernet frames transmitted with errors detected.

VIDEO Tab Display

Select the VIDEO tab to view the status of the video in the stream.

IP Session		Run Time: 0d, 02:06:01	Running		
LAYER 1/2	VIDEO	AUDIO	DATA	PTP	NMOS
		PORT 1	PORT 2		
L3 IP					
Source Addr		192.168.1.26	192.168.1.27		
Destination Addr		229.20.1.12	229.20.2.12		
L4 UDP					
Source Port		50011	50011		
Destination Port		50011	50011		
L5 RTP					
Version		2	2		

Elements of the VIDEO Tab Display

- L3 IP:
 - Source Addr: Lists the source addresses for the L3 IP layer.
 - Destination Addr: Lists the destination addresses for the L3 IP layer.
- L4 UDP:
 - Source Port: Lists the source ports for the L4 UDP layer.
 - Destination Port: Lists the destination ports for the L4 UDP layer.

- L5 RTP: Lists these parameters of the L5 RTP (Real Time Protocol) layer. RTP Datagrams are defined in IETF RFC 3550.
 - Version: Identifies the version of RTP and should be a value of 2.
 - Padding: Indicates whether padding bytes are present. Possible values are:
 - false: Indicates no extra padding bytes are at the end of the RTP packet.
 - true: Indicates that padding octets have been added to the RTP packet that are not part of the payload.
 - Extension: Indicates whether an extension is present. Possible values are:
 - false: Indicates no extension is present.
 - true: Indicates an extension is present.
 - CSRC: Identifies the Contributing Source IDs. This value should be set to zero.
 - Marker: This value should be set to 1 to indicate the last MediaDatagram of the video frame. The value is set to 0 for all other Media Datagrams and should be 0 for most packets.

Note: For 2022-6 signals, the status indicator turns red if the Marker Bit Frequency does not match the frame rate indicated in the HBRMT header. For 2110 signals, the status indicator turns red if the Marker Bit Frequency does not match the measured field rate of the detected format.

- Payload type: Identifies the type of RTP payload:
 - 98: Indicates a SMPTE 2022.6 High Bit-rate Media transport.
 - 99: Indicates a SMPTE 2022.5 High Bit-rate Media Forward Error Correction (FEC) payload.
 - 33: Indicates a SMPTE 2022.2 Constant Bit Rate MPEG-2 Transport Stream Adaptive Sample Picture Encapsulation (ASPEN) payload.

Note: *The Payload type for ST2110 streams should be between 96 and 127. The Payload type is set by the user/device.*

- Sequence number: RTP sequence counter that changes by one for each RTP Media Datagram that is sent.

Note: The status indicator turns red if the received RTP sequence numbers do not change by 1 on every packet.

- Time Stamp: The timestamp reflects the sampling instant of the first octet in the RTP datagram. This value can be used to determine packet sequence errors and jitter calculations to be made.

Note: For 2022-6 signals, the status indicator turns red if the Time Stamp field does not change at the rate of 27 MHz on every packet. For 2110 signals, the status indicator

turns red if the Time Stamp field does not change at the start of every field or frame at the rate of 90 kHz on every packet.

- SSRC: Identifies the Synchronization Source ID and is set in compliance with RFC3550. This identifier is chosen randomly and should be unique so no two SSRC have the same value with an RTP session.
 - Interface Sampling Frequency Error: This error indicates that the incoming video is arriving at a frequency outside of the supported range to maintain stable video lock. The signal on the SDI Out video connector may be affected. Possible interface sampling frequency declaration in stream header is incorrect for the stream type being carried.
-

Note: The status indicator turns red if the received frame rate is not stable enough during conversion to SDI. Marker Bit Frequency Errors can also trigger this indicator.

- HBRMT: Lists these parameters of the High Bit Rate Media Payload Header:
-

Note: The HBRMT parameters do not apply to ST2110-20 streams.

- Video Source Format: Identifies whether source formatting is present:
 - Not Present: Indicates no Source Format information is present.
 - Present: Indicates source formatting is present.
- Video Source ID: Identifies the video source:
 - Primary (0x0): Indicates a primary stream.
 - Protect (0x1): Indicates a protected stream.
 - Reserved (n): When n is a number other than 0 or 1, indicates that a reserved value is being used.
 - Frame Count: The Video Frame counter changes in value for the next RTP sequence and rolls over after 255.

Note: The status indicator turns red if the frame count field does not change by 1 at the start of every frame.

- Reference for time stamp: Identifies the time stamp reference:
 - Unlocked (0x0): Indicates the time stamp is not locked to any particular source.
 - Reserved (0x1): Indicates an illegal value.
 - UTC (0x2): Indicates the time stamp is locked to a UTC time source.
 - Private (0x3): Indicates the time stamp is locked to a private time source.
- Video Payload Scrambling: Identifies the payload scrambling status:
 - Unscrambled (0x0): Indicates the payload is not scrambled.
 - Reserved (n): When *n* is a number other than 0, it indicates a reserved value is being used.
- FEC usage: Identifies the FEC usage status:
 - No FEC (0x0): Indicates no forward-error correction is being used.
 - Column (0x1): Indicates column FEC is being used.
 - Col/Row (0x2): Indicates column and row FEC are being used.
 - Reserved (n): When *n* is a number greater than 2, indicates a reserved value is being used.
- Clock Frequency: Identifies the video word clock frequency of the payload video. Possible values are:
 - 0000: No time stamp
 - 0001: 27 MHz
 - 0010: 148.5 MHz
 - 0011: 148.5 /1.001 MHz
 - 0100: 297 MHz
 - 0101: 297/1.001 MHz
 - 0110-1111: Reserved
- Reserved: This value should be set to 0.
- Video Source Format fields: These Video Source Format field values are displayed:
 - MAP: Identifies which SMPTE mapping scheme is used. Possible values are: Direct (0x0), LevelB (0x1), 2xHD (0x2), or Reserved (n).
 - FRAME: Identifies the raster size. Possible values are: Unspecified (0x0), 720x480i (0x10), 720x576i (0x11), 1920x1080i (0x20), 1920x1080p (0x21), 1920x1080sf (0x22), 2048x1080p (0x23), 2048x1080sf (0x24), or 1280x720p (0x30).
 - F rate: Identifies the frame rate. Possible values are: Unknown/Unspecified frame rate 2.970 GHz signal (0x00), Unknown/Unspecified frame rate 2.970/1.001 GHz signal (0x01), Unknown/Unspecified frame rate 1.485 GHz signal (0x02), Unknown/Unspecified frame rate 1.485/1.001 GHz signal (0x03), Unknown/Unspecified frame rate 0.270 GHz signal (0x04), Reserved (0x04-0x0f), 60 (0x10),

60/1.001 (0x11), 50 (0x12), Reserved (0x13), 48 (0x14), 48/1.001 (0x15), 30 (0x16), 30/1.001 (0x17), 25 (0x18), Reserved (0x19), 24 (0x1A), 24/1.001 (0x1B), Reserved (0x1C-0xFF).

Sample: Identifies the pixel sampling/quantization scheme. Possible values: Unspecified (0x0), 4:2:2/10bit (0x1), 4:2:2/12bit (0x5), or 4:2:2:4/12bit (0x8).

Fmt-Reserve: This bit is reserved for future use and is set to 0.

- Video TimeStamp: Shows the value of a free running counter that is synchronous with the interface word clock of the encapsulated video. This timestamp is fixed at the transmitter to the first information contained in the datagram.
- Header Extension: Indicates the number of 4-octet Header Extension words that come after the HBRMT payload.

Audio Tab Display

Select the AUDIO tab to view the status of the audio in the stream.

IP Session		Run Time: 0d, 15:19:45		Running	
LAYER 1/2	VIDEO	AUDIO-1	DATA	PTP	NMOS
		PORT 1	PORT 2		
L3 IP					
Source Addr		173.100.1.2	173.100.1.2		
Destination Addr		229.30.21.2	229.30.21.2		
L4 UDP					
Source Port		50000	50000		
Destination Port		50030	50030		
L5 RTP					
Version		2	2		

Set the Audio Stream

1. Select the **Tile** icon () in the application toolbar to open the IP Session Settings menu.

2. In the Audio drop-down menu, select the stream number to monitor.
The selected audio stream is noted in the AUDIO tab.

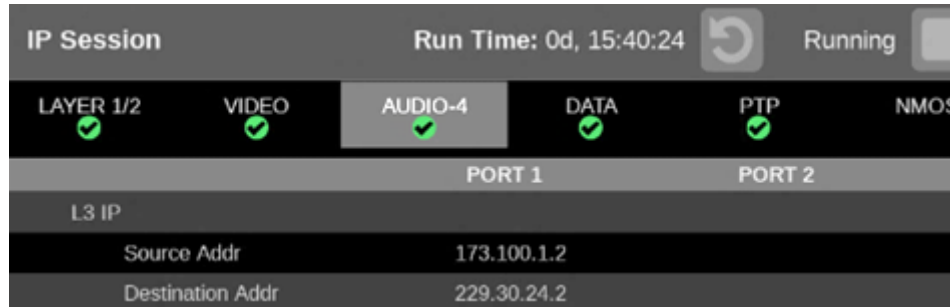

3. Close the settings menu.

Elements of the AUDIO Tab Display

- L3 IP
 - Source Addr: Lists the source addresses for the L3 IP layer.
 - Destination Addr: Lists the destination addresses for the L3 IP layer.
- L4 UDP
 - Source Port: Lists the source ports for the L4 UDP layer.
 - Destination Port: Lists the destination ports for the L4 UDP layer.
- L5 RTP: Lists these parameters of the L5 RTP (Real Time Protocol) layer. RTP Datagrams are defined in IETF RFC 3550.
 - Version: Identifies the version of RTP and should be a value of 2.
 - Padding: Indicates whether padding bytes are present. Possible values are:
 - false: Indicates no extra padding bytes are at the end of the RTP packet.
 - true: Indicates that padding octets have been added to the RTP packet that are not part of the payload.
 - Extension: Indicates whether an extension is present. Possible values are:
 - false: Indicates no extension is present.
 - true: Indicates an extension is present.
 - CSRC: Identifies the Contributing Source IDs. This value should be set to zero.
 - Marker: This value should be set to 1 to indicate the last MediaDatagram of the video frame. The value is set to 0 for all other Media Datagrams and should be 0 for most packets.
 - Payload type: Identifies the type of RTP payload.
 - Sequence number: RTP sequence counter that changes by one for each RTP Media Datagram that is sent.

Note: The status indicator turns red if the received RTP sequence numbers do not change by 1 on every packet.

- Time Stamp: The timestamp reflects the sampling instant of the first octet in the RTP datagram. This value can be used to determine packet sequence errors and jitter calculations to be made.

Note: The status indicator turns red if the Time Stamp field does not change at 48 kHz rate on every group of audio samples.

- SSRC: Identifies the Synchronization Source ID and is set in compliance with RFC3550. This identifier is chosen randomly and should be unique so no two SSRC have the same value with an RTP session.

Data Tab Display

Select the DATA tab to view the status of the data in the stream.

The screenshot shows the 'IP Session' interface with 'Run Time: 0d, 02:25:13' and a 'Running' status. The 'DATA' tab is selected, indicated by a green checkmark. Below the tabs, the interface is divided into 'PORT 1' and 'PORT 2' columns. The 'L3 IP' section shows 'Source Addr' (192.168.1.26 for PORT 1, 192.168.1.27 for PORT 2) and 'Destination Addr' (229.40.1.12 for both). The 'L4 UDP' section shows 'Source Port' and 'Destination Port' (both 50011 for both ports). The 'L5 RTP' section shows 'Version' (2 for both ports). All status indicators are green.

	PORT 1	PORT 2
L3 IP		
Source Addr	192.168.1.26	192.168.1.27
Destination Addr	229.40.1.12	229.40.2.12
L4 UDP		
Source Port	50011	50011
Destination Port	50011	50011
L5 RTP		
Version	2	2

Elements of the DATA Tab Display

- L3 IP
 - Source Addr: Lists the source addresses for the L3 IP layer.
 - Destination Addr: Lists the destination addresses for the L3 IP layer.
- L4 UDP
 - Source Port: Lists the source ports for the L4 UDP layer.
 - Destination Port: Lists the destination ports for the L4 UDP layer.

- L5 RTP: Lists these parameters of the L5 RTP (Real Time Protocol) layer. RTP Datagrams are defined in IETF RFC 3550.
 - Version: Identifies the version of RTP and should be a value of 2.
 - Padding: Indicates whether padding bytes are present. Possible values are:
 - false: Indicates no extra padding bytes are at the end of the RTP packet.
 - true: Indicates that padding octets have been added to the RTP packet that are not part of the payload.
 - Extension: Indicates whether an extension is present. Possible values are:
 - false: Indicates no extension is present.
 - true: Indicates an extension is present.
 - CSRC: Identifies the Contributing Source IDs. This value should be set to zero.
 - Marker: This value should be set to 1 to indicate the last MediaDatagram of the video frame. The value is set to 0 for all other Media Datagrams and should be 0 for most packets.

Note: For 2022-6 signals, the status indicator turns red if the Marker Bit Frequency does not match the frame rate indicated in the HBRMT header. For 2110 signals, the status indicator turns red if the Marker Bit Frequency does not match the measured field rate of the detected format.

- Payload type: Identifies the type of RTP payload.
- Sequence Number: RTP sequence counter changes in increments of one for each RTP Media Datagram that is sent.
- Time Stamp: The timestamp reflects the sampling instant of the first octet in the RTP datagram. This value can be used to determine packet sequence errors and jitter calculations to be made.

Note: For 2022-6 signals, the status indicator turns red if the Time Stamp field does not change at the rate of 27 MHz on every packet. For 2110 signals, the status indicator turns red if the Time Stamp field does not change at the start of every field or frame at the rate of 90 kHz on every packet.

- SSRC: Identifies the Synchronization Source ID and is set in compliance with RFC3550. This identifier is chosen randomly and should be unique so no two SSRC have the same value with an RTP session.

PTP Tab Display

Select the PTP tab to view the status of the PTP elements in the stream. PTP is currently only supported on 10GE SFP Port 1, for instructions on locking to PTP see [Configure Reference Settings](#).

LAYER 1/2	VIDEO	AUDIO	DATA	PTP	NMOS
✓	✗	✓	✓	✓	
✓ Lock Status				Locked	
PTP Time				2018-06-12 22:28:54 (UTC)	
Master/Slave Phase Lag				+ 83 ns	
Grandmaster ID				08:00:11:ff:fe:21:90:2b	
Steps Removed				2	
Domain				110	
Profile				General	
Delay Message Interval				Follow Master	
Grandmaster BMCA Values					

Elements of the PTP Tab Display

- Lock Status: Indicates whether the instrument PTP slave is locked to the master PTP signal for the selected domain. These values may appear:
 - No master present: Indicates that the master PTP clock has not been detected on the selected domain.
 - Locked: Indicates that the master PTP clock is detected and there is less than 1000 ns of phase lag between the master clock and the instrument.
 - Unlocked: Indicates that the master PTP clock is detected and there is greater than 1000 ns of phase lag between the master clock and the instrument.
- PTP time: Shows the time derived from the PTP Master as UTC (Coordinated Universal Time).
- Master/Slave Phase Lag: Shows the detected offset between the master and slave clocks.
- Grandmaster ID: Shows the MAC Address of PTP Master with the bytes ff:fe inserted in the middle. This ID is also used in the BMCA as a tiebreaker if all of the parameters match down through priority 2.
- Steps Removed: Shows the number of communication paths traversed between the local clock and the Grandmaster clock.
- Domain: Shows the domain being used. Domains allow multiple PTP services to coexist simultaneously on one physical Ethernet connection.
- Profile: Shows the profile being used: General, AES67, or ST2059. This is the user-selected profile set on the Settings > Reference configuration menu page and is not detected on the input.

- Delay Message Interval: For Multicast communication mode, the only delay message interval allowed is "Follow Master". In this mode, the slave sets the delay request rate according to the information sent by the master in the delay response message.

Note: The PRISM monitor currently supports Multicast communication mode and SMPTE mixed mode without negotiation. In later firmware releases, other communication modes will be supported.

- Grandmaster BCMA Values: Lists these values for the Grandmaster BCMA (Best Master Clock Algorithm) in order of precedence:
 - Priority 1: This parameter defines which clocks are allowed to be considered as masters. To be considered as a master, the value should be set to 128 or less. Priority 1 is the first criteria in the BMCA, so if Priority 1 is set to a lower value than other devices on the system, then it is chosen even if the clock quality is poor. Typically, all the masters in a domain should have the same value for the Priority 1 parameter.
 - Clock Class: This value characterizes the TAI (International Atomic Time) traceability. The clock class value varies to indicate the type of reference in use by the Grandmaster clock. For example, when locked to GPS the PTP grandmaster reports a class 6. However, if in holdover mode after locking to GPS, then it reports a class of 7.
 - Clock Accuracy: This value characterizes the clock accuracy for the purpose of determining the best master clock.
 - Clock Variance: This value is reported by the PTP master to indicate the variance of the clock over a one second interval. A lower number indicates a more stable clock and is preferred by the BMCA.
 - Priority 2: This parameter is used to break the tie between masters that have the same clock quality. Several values may be used to define a hierarchy of devices. Most profiles use 128 as a default, so a value of 127 or lower would indicate a preferred master.
- Clock Source: The clock source field is not used by the BMCA. The field is set to indicate the type of reference in use by the Grandmaster clock.
- Communication Mode: There are three basic message modes for PTP: Multicast, Unicast, and mixed Multicast and Unicast. For full Multicast or Unicast modes, all of the PTP messages are sent in the selected mode type.

Note: The PRISM monitor currently supports Multicast communication mode and SMPTE mixed mode without negotiation. In later firmware releases, other communication modes will be supported.

For some profiles, such as some telecom profiles and the SMPTE ST2059 profile, a mixture of Multicast and Unicast are allowed. On the SMPTE profile unique mixed

mode, the Announce and Sync messages are sent as multicast. However, the Delay request and Delay Response messages are sent as Unicast.

- Some points to understand about communication modes:
- Whatever mode is chosen, the master and slave must match or be compatible.
- Multicast and Mixed mode may need IGMP joins and leaves Full Unicast must have the master address in all slave AMTs.
- Unicast without negotiation does not allow master to regulate load.
- Two masters can be used on different domains to serve slaves on different communication modes.

- **Delay Mechanism:** Shows the delay mechanism mode being used:

Note: The PRISM monitor currently supports only the End-to-End delay mechanism.

- **End-to-End:** In this mode, the sync, follow up, delay request, and delay response messages go through the network all the way between the master and slave. End-to-End mode is useful in PTP networks where some or all devices are not PTP aware.
- **Peer-to-Peer:** In this mode, the Pdelay request and Pdelay response messages are local to each link in the network. Each device determines the local link and device delays. The sync message from the master then collects the corrections as it propagates from the master to slave. Peer-to-Peer mode is useful in PTP networks where the routing configuration changes. For Peer-to-Peer mode to work well, all of the devices need to be PTP aware.

- **Message rates:**

- **Announce:** Displays the rate of the Announce messages received from the master. Typical values are 1 to 4 messages a second, but a wide range is allowed by some profiles. If the value is lower than expected, it may indicate a problem in the network or the master.
- **Sync:** Displays the rate of the Sync messages received from the master. Typical values are 1 to 16 messages a second, but some profiles allow much higher rates. If the value is lower than expected, it may indicate a problem in the network or the master.
- **Delay Request:** Displays the rate of the Delay Request messages sent by the slave. In multi-cast mode, the Delay Request rate is required to be set in response to a field in the Delay Response message from the master. Typically the master sets this field such that the DelayRequest message rate is equal to the Sync message rate.

Note: For SMPTE mixed mode, PRISM sets the delay Request rate equal to the Sync message rate received from the master.

- **Delay Response:** Displays the rate of the Delay Response messages received from the master. Each Delay Request should have a matching Delay Response, so

if the value is lower than expected then it may indicate a problem in the network or the master

NMOS Tab Display

Select the NMOS tab to view the registration server information, server list and the last SDP file received.

To enable and configure NMOS see [Enable NMOS Discovery and Registration](#).

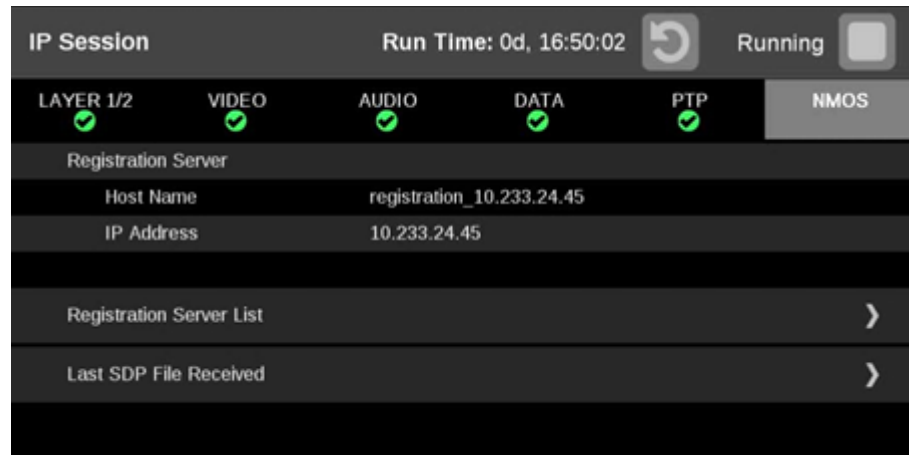

- Registration Server: Shows the Host Name and IP Address of the registration server.
- Registration Server List: Select the Registration Server List tab to view the Host Name, IP Address, and Priority of the servers registered to this instrument using NMOS.

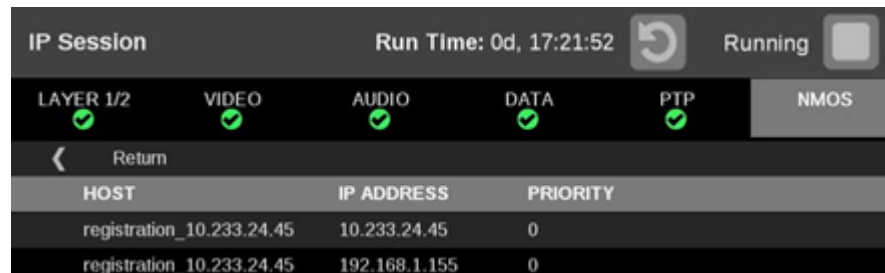

Note: Select **Return** to go back to the main IP Session NMOS menu.

- Last SDP File Received: Select the Last SDP File Received tab view video, audio, and data SDP files. These files contain information used to configure input signals from the registration servers.

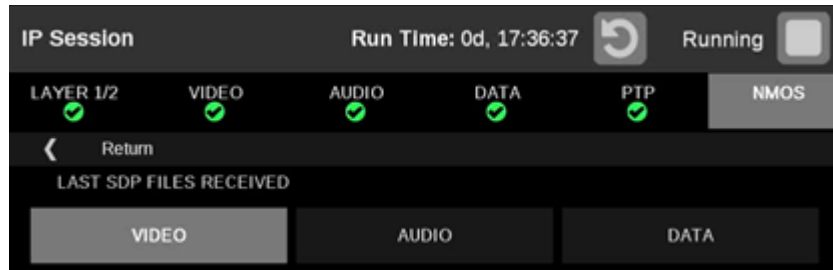

Note: Select **Return** to go back to the main IP Session NMOS menu.

IP Graphs Application

Use the IP Graphs application to view various graphs that show aspects of the IP stream. As you scroll through the various graphs, the top of the selected graph moves to the top of the display area to help view the complete graph. The displayed graph is included in a saved preset.

Note: Option MP2-IP-MEAS must be installed to use the IP Graphs application.

If ST2022-7 monitoring is configured, the IP Graphs application includes Path 1 and Path 2. The graph data can be switched between viewing only Path 1, only Path 2, or both by selecting the Path button in the upper right of the screen.

Note: The Path button only works with 2022-7 seamless switching enabled in input configuration.

Note: If 2110 monitoring is configured, you can select Video, Audio (1 stream at a time, selectable in Tile Settings), or Data.

If ST2022-6 monitoring is configured, the IP Graphs include:



Video CRC Error graph: The Video CRC Error graph shows any present CRC errors in the currently decoded signal and can be compared to other time graphs such as RTP Sequence Errors.

TS-DF graph: The TS-DF graph shows the Time Stamped Delay Factor, as defined in EBU Tech 3337, which is a method for measuring network jitter in RTP streams.

IP Graphs Settings Menu

Note: The Move icon () is in the settings menu header. Select this icon to move the settings left or right.

Open the IP FGraphs Settings menu:

1. Select the **Tiles** icon ()
2. Select the tile with the IP Graphs application.
3. Select the **Tile** icon ()

Trend Interval

Select the drop-down menu to change the interval to 1 minute, 5 minute, 10 minute, 30 minute, 1 hour, 3 hour, 6 hour, 12 hour, or 1 day.

Audio

Select the drop-down menu to select a stream to monitor. The monitored stream is noted in the IP Graphs header, next to the Stream type button.

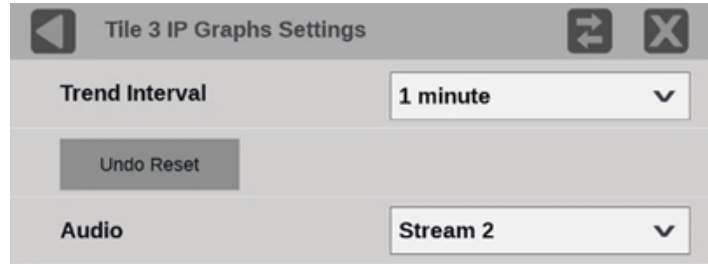

Elements in IP Graphs Application Display

The elements at the top of the IP Graphs application are shared between all graphs.

Note: Only Path 1 displays unless you enable ST2022-7 Seamless Switching, (see [Configure Instrument for HDR/WCG Monitoring](#)).

- PATH 1 and PATH 2: The description of the two information paths.
- Port: Shows the physical port used on the instrument.
- Src: Lists the source address of the IP stream.
- Dest: Lists the destination address of the IP stream.
- Protocol: Lists the protocol being used by the monitored stream.
- PRS: Shows the Packet Read Schedule (PRS) defined in the input video settings.
- Clear icon: Select the Clear icon (🔄) to reset the monitoring session.
- Stream type: Select this button to change to Video, Audio, or Data stream IP graphs.
- Path: Select the Path button to change to Path 1, Path 2, or both Path 1 and 2.
- Res: Lists the resolution of the graph display at the bottom right of the graph.



Total Bit Rate Graph

The Total Bit Rate graph shows the total bit rate currently on the 10GE input. The maximum available bandwidth is 10.3 Gb/s. These readouts appear:

- Max: Shows maximum bandwidth used during the time window.
- Mean: Shows the mean bandwidth used during the time window.
- Min: Shows the minimum bandwidth used during the time window.
- Free Min: Shows the minimum available bandwidth that is not in use.
- Free Max: Shows the maximum available bandwidth that is not in use.

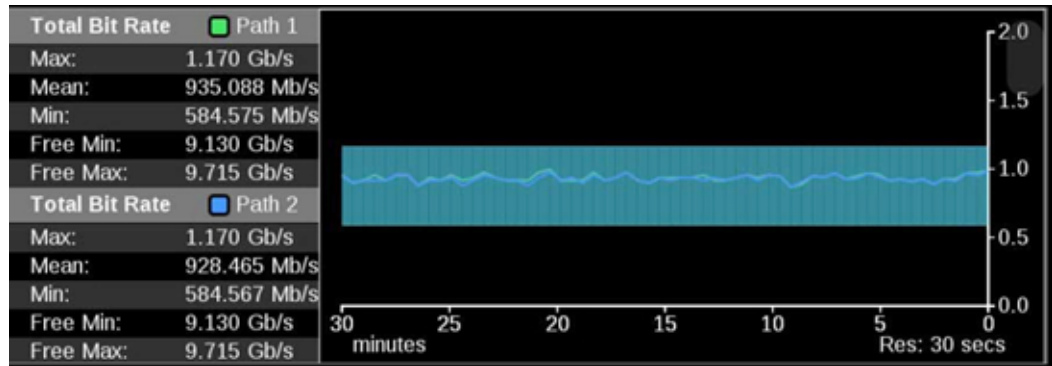

Session Bit Rate Graph

The Session Bit Rate graph shows the data rate of the currently selected input stream.

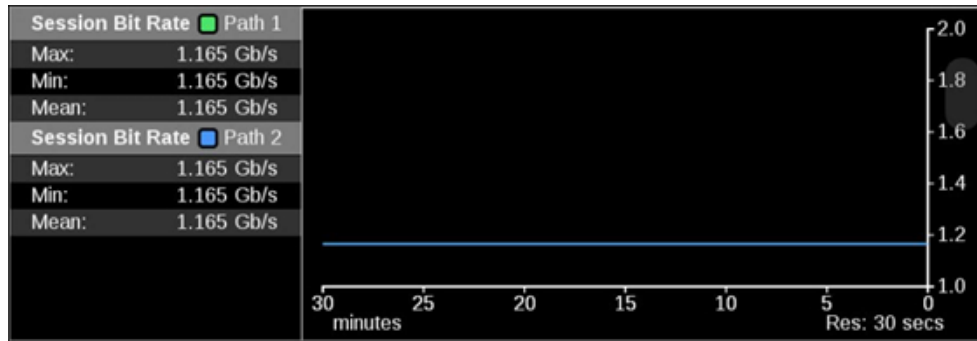

PIT Graph

The PIT (Packet Interval Time) graph shows the difference in arrival time between sequential packets of the active stream. This is one indication of the packet jitter and dropped packet rate. The colored bars represent the range from minimum to maximum for all of the packets within that time interval.

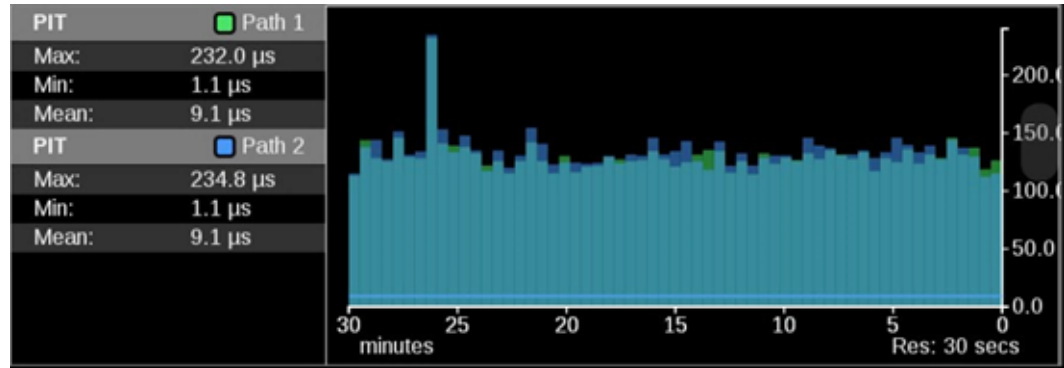

RTP Sequence Error Graph

The RTP Sequence Error: Shows the RTP sequence information and reports if any packet is received out of order.

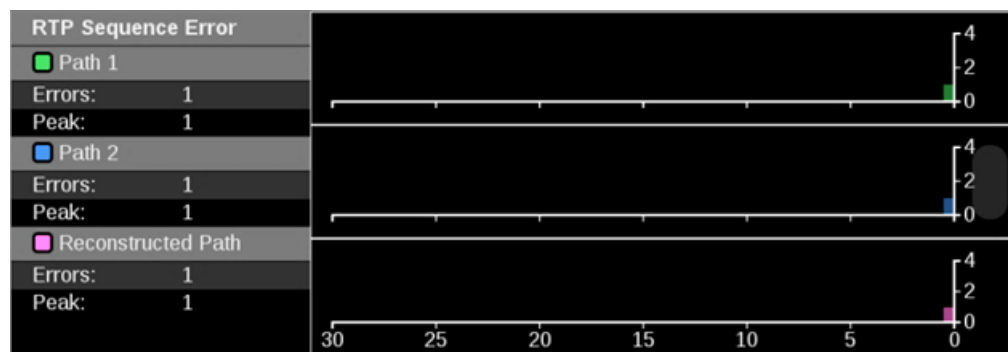

Reconstructed path errors: In addition to counting Path 1 and Path 2 RTP sequence errors, the number of packets that could not be corrected is shown. An output packet could be uncorrected if it is dropped on both paths or there is too much skew between the paths resulting in a buffer overflow.

The number of reconstructed path errors also applies to situations when ST2022-7 is turned off. Packets could pass uncorrected if they are dropped or if reordering results in an input buffer overflow.

Path1-Path2 Differential Graph

Path Differential represents the time difference between the Path 1 and Path 2 streams in a ST2022-7 system. As the path differential gets larger, it becomes more difficult for equipment receiving the data to properly process both paths, depending on the size of the input buffer in the equipment.

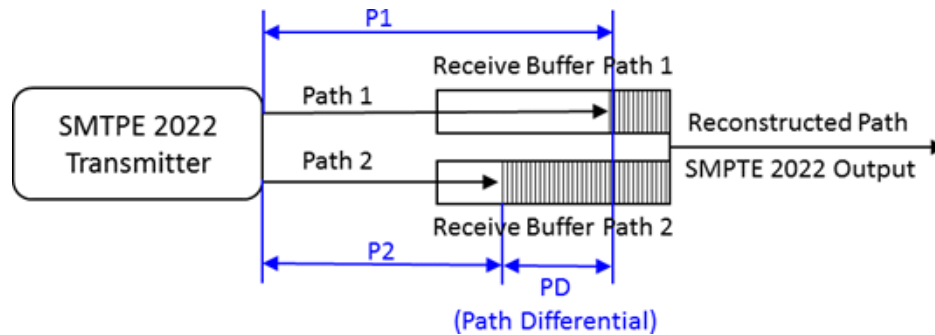

The ST2022-7 specification defines Path Differential as an absolute value, but the Path1-Path2 Differential graph shows the signed value of Path 1 minus Path 2. A positive value means that Path 2 is lagging Path 1. The ST2022-7 specification defines Path Differential as an absolute value, but the Path1-Path2 Differential graph shows the signed value of Path 1 minus Path 2. A positive value means that Path 2 is lagging Path 1.

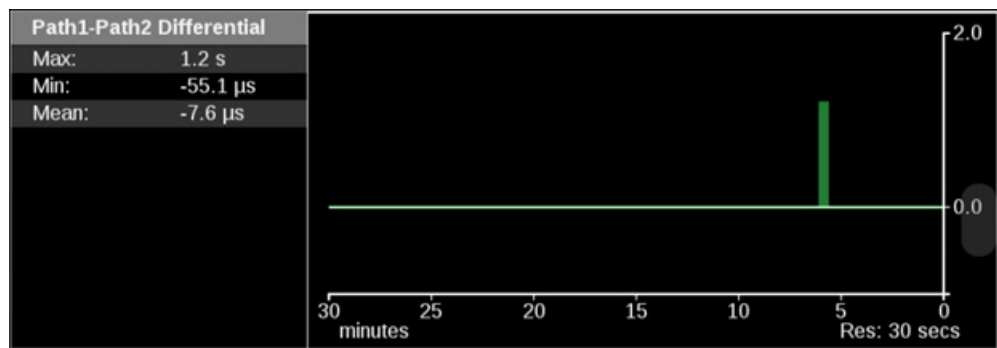

Note: The measurement range of Path1-Path2 differential measurement is 1 second.

Note: The Path1-Path2 differential measurement is not supported for ST2110-30.

CMAX and VRX Buffer Graph

ST2110-21 specifies a timing model for ST2110-10 video RTP streams with these parametric models:

Note: The CMAX and VRX trend graphs are only available for 2110 streams.

Note: Make sure the input signal and PRISM are locked to PTP for these measurements.

- A network compatibility model to regulate the burst characteristics of senders, which promotes the compatibility with the switches. The CMAX section provides a trend graph for this type of modeling.
- A virtual receiver buffer model to ensure there is no buffer overflow or underflow in the receiver that could cause the packet loss and picture quality degradation. The VRX Buffer section provides a trend graph for this type of modeling.

Both trend graphs help engineers properly setup the packet delivery timing in the RTP packet sender.

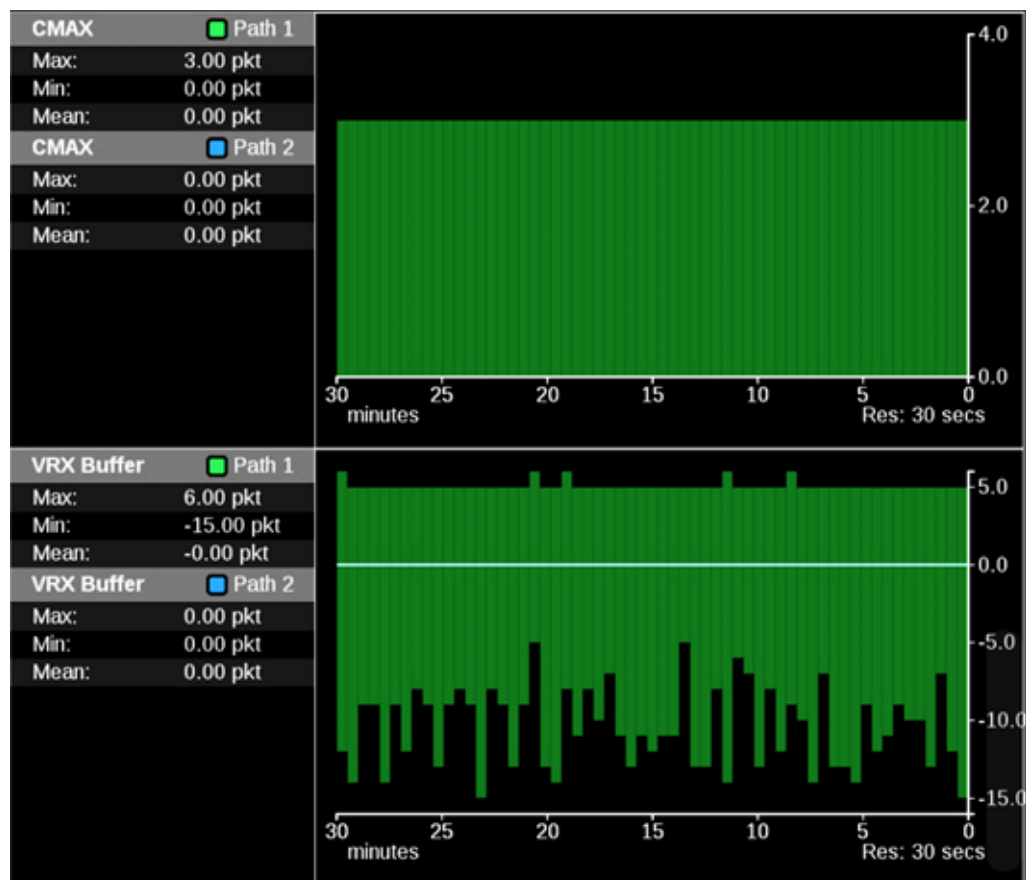

PIT Histogram Application

Use the PIT (Packet Interval Time) Histogram application to monitor the network delay variation statistics.

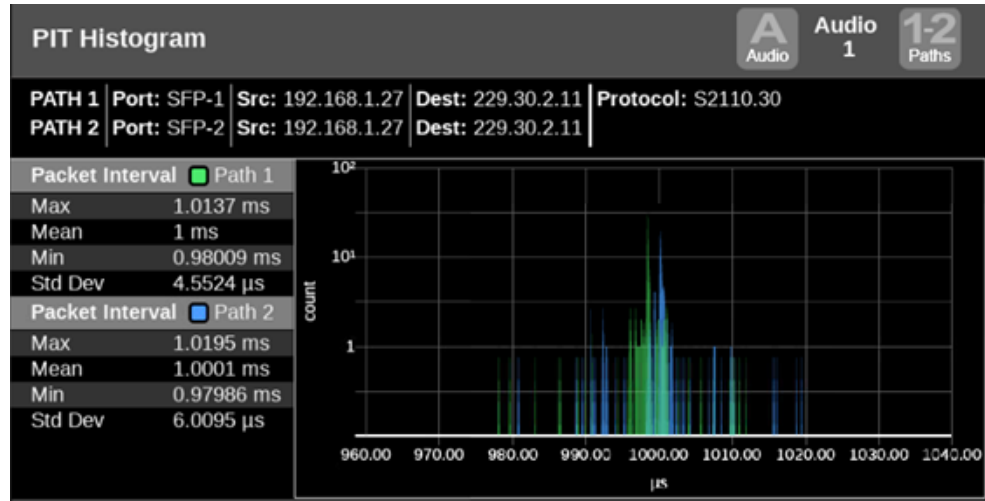

Note: If 2110 monitoring is configured, you can select Video, Audio (1 stream at a time, selectable in Tile Settings), or Data.

PIT Histogram Settings Menu

Open the PIT Histogram Settings menu:

1. Select the **Tiles** icon (🧩).
2. Select the tile with the PIT Histogram application.
3. Select the **Tile** icon (⚙️).

Y-Axis Scaling: Select Linear or Log for the y-axis scaling.

Note: The Move icon (👉) is in the settings menu header. Select this icon to move the settings left of right.

Audio: Select the drop-down menu to choose the audio stream to monitor. The selected audio stream is noted in the PIT Histogram heading next to the monitored path.

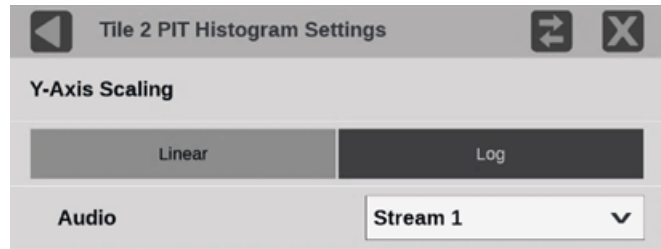

Elements of the PIT Histogram Display

Port 1 and Port 2: Shows the physical ports on the instrument.

Src/Dest: Lists the source and destination addresses of the IP stream.

Protocol: Lists the protocol being used by the monitored stream.

Path: Select the button, in the upper right corner of the tile, to switch between Path 1 only (green), Path 2 only (blue), or both Path 1 and Path 2 data (cyan where Path 1 and 2 are overlapped).

Note: The Path button only works with 2022-7 seamless switching enabled in input configuration.

Stream type: Select this button to switch between the video, audio, or data stream IP graphs.

Note: The Stream Type button is only available with 2110 streams.

Packet Interval information:

- Max: Shows maximum packet interval time.
- Mean: Shows the mean packet interval time.
- Min: Shows the minimum packet interval time.
- Std Dev: Shows the standard deviation of the packet interval time.

Use the pinch and pinch-out gestures on the graph to zoom in and out. After using the zoom-in gesture, the text "Zoomed" is displayed on the x axis of the graph.

Note: When using a keyboard and mouse, click and drag to zoom in.

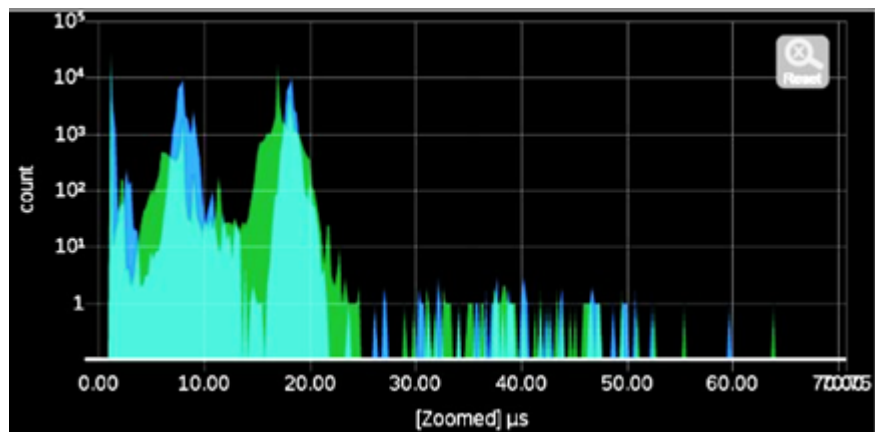

Select the **Reset** button () to set the graph back to autoscale mode.

Note: The Reset button is only displayed after zooming in.

PTP Graphs Application



Use the PTP Graphs application to monitor the message timing between Master and Slave in a PTP network.

For more information on PTP operations and settings, see [Configure Reference Settings](#) and [PTP Introduction](#).

Note: Option MP-IP-MEAS must be installed to use the PTP Graphs application.

PTP graphs Settings Menu

Open the PTP Graphs Settings menu:

1. Select the **Tiles** icon ().
2. Select the tile with the PTP Graphs application.
3. Select the Tile icon ().

Note: The Move icon () is in the settings menu header. Select this icon to move the settings left of right.

PTP Trend Interval: The extent of the horizontal axis on the graph. Select the drop-down menu to choose the interval:

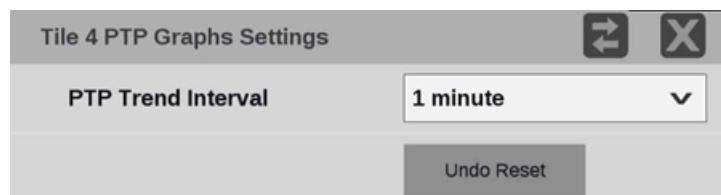

Elements of the PTP Graph

The PTP graphs are useful in observing the effects of traffic on the PTP messages and the operation of transparent and boundary clocks. Non-PTP aware switches may have

significant PTP delay variations, while transparent and boundary clocks have much less variation and total delay.

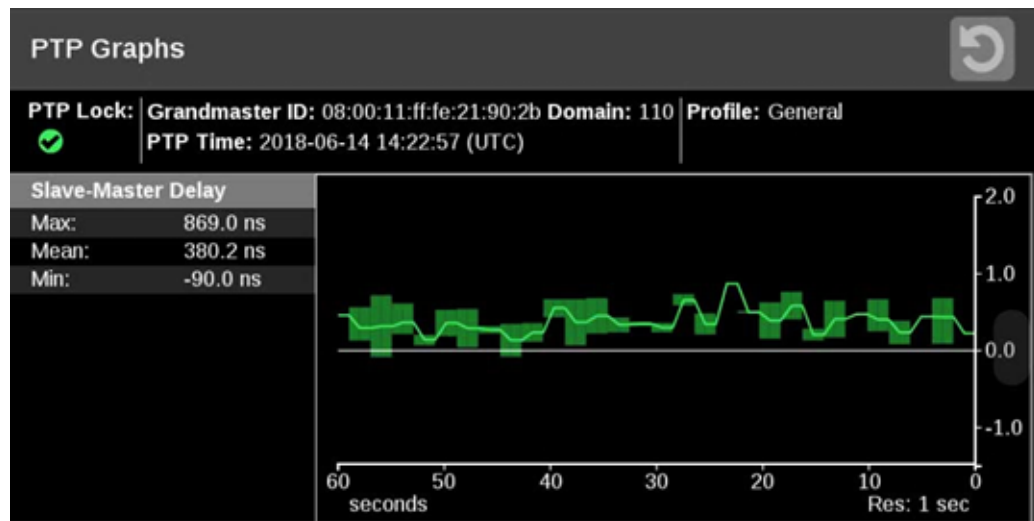

Elements of the Display Heading

- PTP Lock: Shows the status of the PTP lock.
- Grandmaster ID: Displays the reference Source and Domain.
- PTP Time: Time of day derived from the PTP signals.
- Profile: Shows the profile which has been selected in the reference settings menu. This is not detected from the incoming PTP messages.
- Resolution: The time increment for each bar on the display. Longer graph settings collect data into larger bins to be displayed. This range and resulting resolution are selected in the setting menu for PTP graphs.
- Trace Types: There are four displays available. For each one, the Max., Min., and Mean (average) are shown on the left, while the traces versus time is shown on the right. The traces indicate the Max, and Min envelope, and the Mean (average) for each time bin. The time scale can be adjusted in the settings menu. The data is logged for 1 day so you can go back and look at long-term trends.

Use the slider to move the displays up or down.

- Slave-Master Delay: This graph indicates the difference in the time stamps for the PTP Sync messages; these go from the master to the slave. This display indicates effects of the downstream network delay and adjustments made to the slave clock. After the slave is locked and the timing is stable, the perturbations on this graph are largely due to network variations. Traffic often causes some messages to be delayed so the maximum delay increases.

As the PTP is locking, the slave clock adjusts, so the trace may have large swings or jumps. As the system locks, the master-to-slave and slave-to-master delays

should converge on the same value. This value represents the average network delay between the master and slave for the traffic in both directions.

If the network delay is too unstable, then the PTP might never lock. This appears as large variations on this trace.

- **Master Slave Variation:** The master-to-slave variation graph is derived from the same data as the master-to-slave delay. The absolute value of the changes in delay are filtered according to RFC1889 and displayed. This display then shows a measure of the variation of the network delay. A low value indicates a PTP slave is likely to quickly lock, a large value indicates it could be difficult for a PTP slave to lock.
- **Slave to Master Delay:** This graph indicates the difference in the time stamps for the PTP Delay Request messages that go from the slave to the master. This display indicates effects of the upstream network delay and adjustments made to the slave clock. After the slave is locked and the timing is stable, the perturbations on this graph are largely due to network variations. Traffic often causes some messages to be delayed so the maximum delay increases.

As the PTP is locking, the slave clock adjusts, so the trace may have large swings or jumps. As the system locks, the master-to-slave and slave-to master-delays should converge on the same value. This value represents the average network delay between the master and slave for the traffic in both directions.

If the network delay is too unstable, then the PTP might never lock. This appears as large variations on this trace.

- **Slave to Master Variation:** The master-to-slave variation is derived from the same data as the master-to-slave delay. The absolute value of the changes in delay are filtered according to RFC1889 and displayed. This display then shows a measure of the variation of the network delay. A low value indicates a PTP slave is likely to quickly lock. A large value indicates it could be difficult for a PTP slave to lock.
- **PTP Phase Lag:** The graph shows the error in the slave clock phase as measured by the PTP time stamps. This value is used to adjust the slave clock to drive the error toward zero.

The PTP phase lag is the phase error of the phase-locked loop, which controls the slave clock. The phase lag is a reasonable estimate of how well the PTP slave is locked to the master; however, the phase lag does not indicate if there is any asymmetry in the network.

Stream Timing Application

The Stream Timing application shows the timing of the video, audio, and data as it was received relative to the embedded RTP time stamps. It also shows the relative delay between Audio/Video and the Data/Video, which is the amount of delay needed to realign the two essence types.

Note: The Stream Timing application requires Option MP2-IP-MEAS.

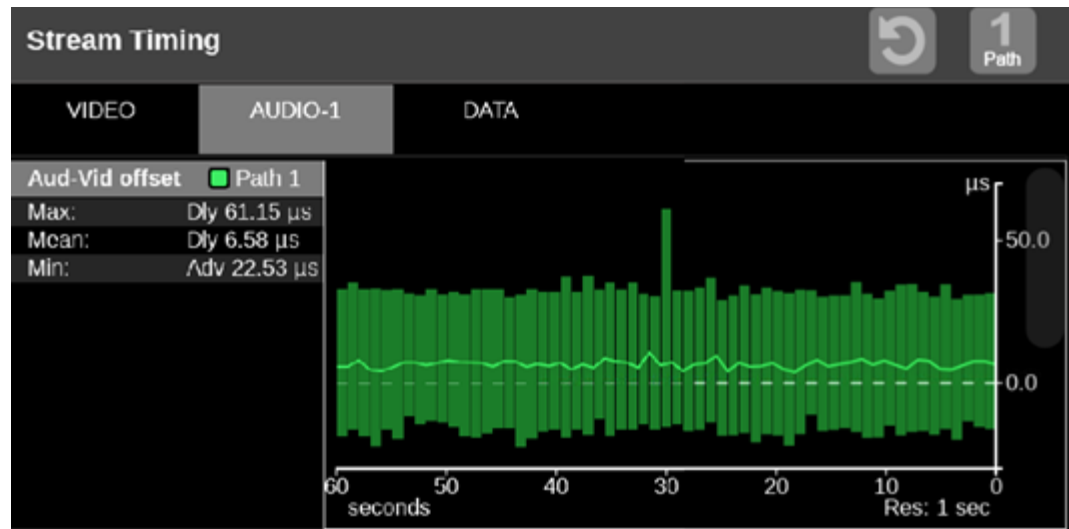

Stream Timing Settings Menu

Open the Stream Timing Settings menu:

1. Select the **Tiles** icon (🧩).
2. Select the tile with the Stream Timing application.
3. Select the **Tile** icon (⚙️).

Note: The Move icon (↔️) is in the settings menu header. Select this icon to move the settings left of right.

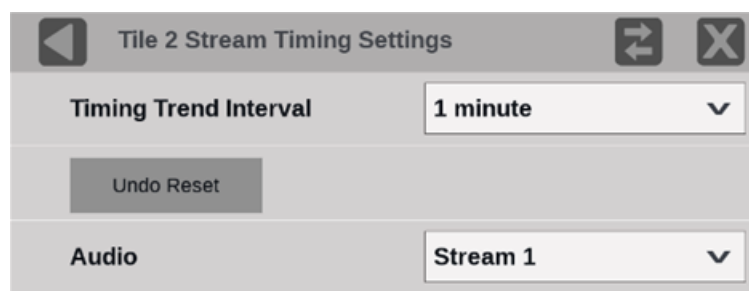

Trend Interval: Select the drop-down menu to choose the interval.

Undo Reset: Select to undo the last clear or reset of the monitoring session.

Audio: Select this drop-down menu to choose the audio stream to monitor. The selected stream is noted in the AUDIO tab label.

Elements of the Stream Timing Display

The elements at the top of the Stream Timing application are shared between all graphs:

Note: Only Path 1 displays, unless you enable ST2022-7 Seamless Switching. (See [Configure Instrument for HDR/WCG Monitoring](#).)

Clear icon: Select the Clear icon (✕) to reset the monitoring session.

Path button: Select the Path button to switch between Path 1, Path 2, or both Path 1 and Path 2.

Stream type tabs: Select these tabs to switch between the stream offset graphs:

VIDEO

AUDIO

Note: The number in the AUDIO tab is the selected stream.

DATA

Res: Lists the resolution of the graph display.

Video Offset Tab

Vid-PTP

The graph shows the relative delay between video stream and PTP. This value indicates the amount of delay that must be applied to realign the video and PTP according to the time stamps. This is a time-based graph of the Timing Display application.

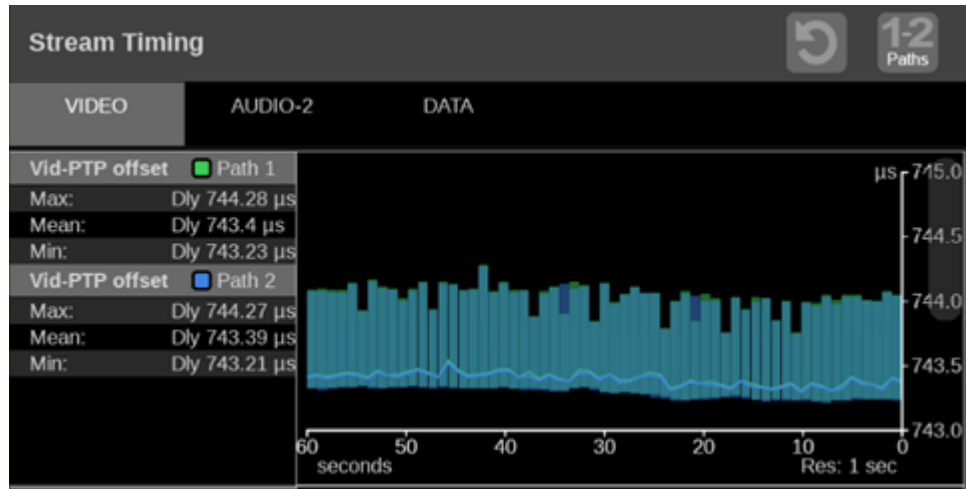

Vid-RTP Offset

The graph shows timing of the video stream as it was received relative to the embedded RTP time stamps.

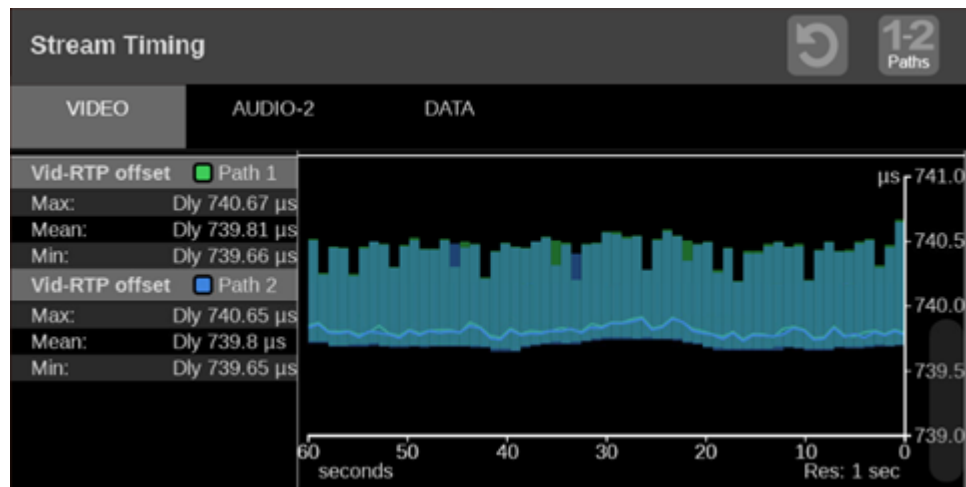

Audio Offset Tab

Aud-Vid Offset

The graph shows the relative delay between audio and video streams. This value indicates the amount of delay that must be applied to realign the signals according to the time stamps.

Note: The selected stream is indicated in the Audio tab as <1-4>.

Note: The audio measurements are logged to a single graph. If you change the audio stream being monitored, we recommend resetting the graph to only see the measurements relative to the current stream.

To change the monitored stream, open the Tile Settings menu.

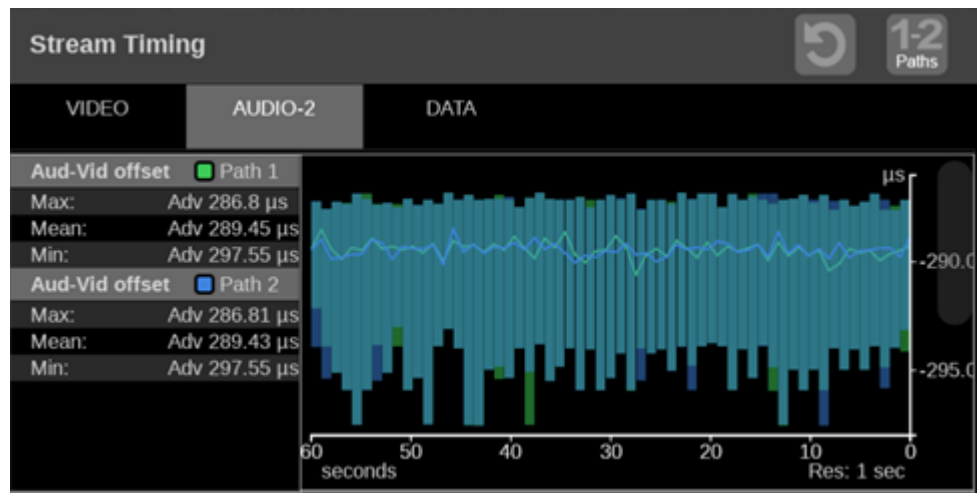

Aud-RTP Offset

The graph shows timing of the audio stream as it was received relative to the embedded RTP time stamps.

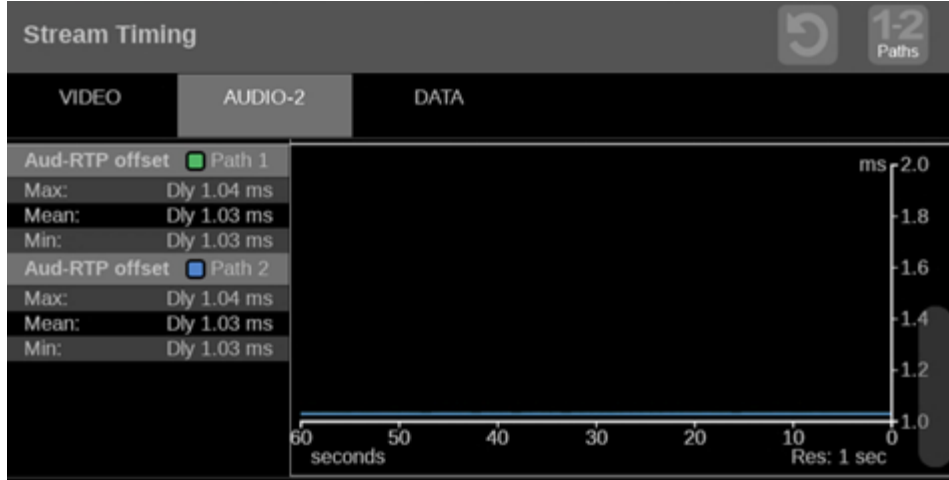

Data Offset Tab

Data-Vid Offset

The graph shows the relative delay between data and video streams. This value indicates the amount of delay that must be applied to realign the signals according to the time stamps.

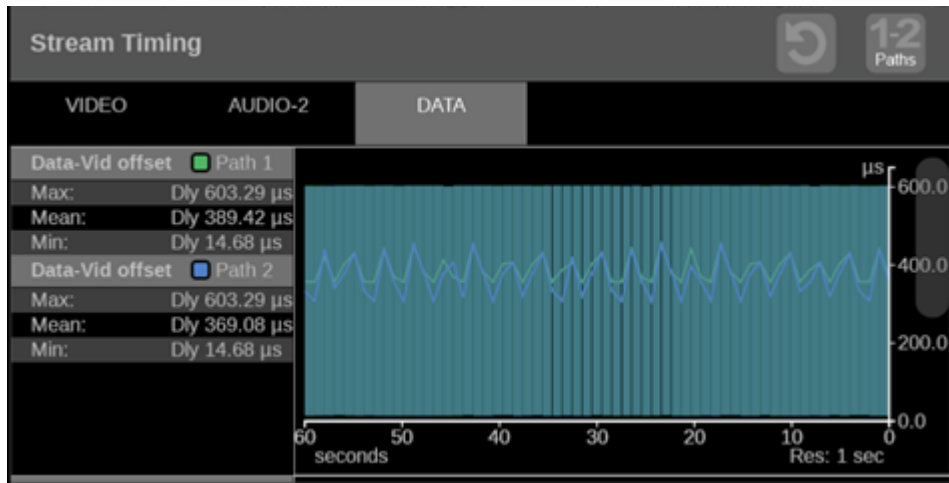

Data-RTP Offset

The graph shows timing of the data stream as it was received relative to the embedded RTP time stamps.

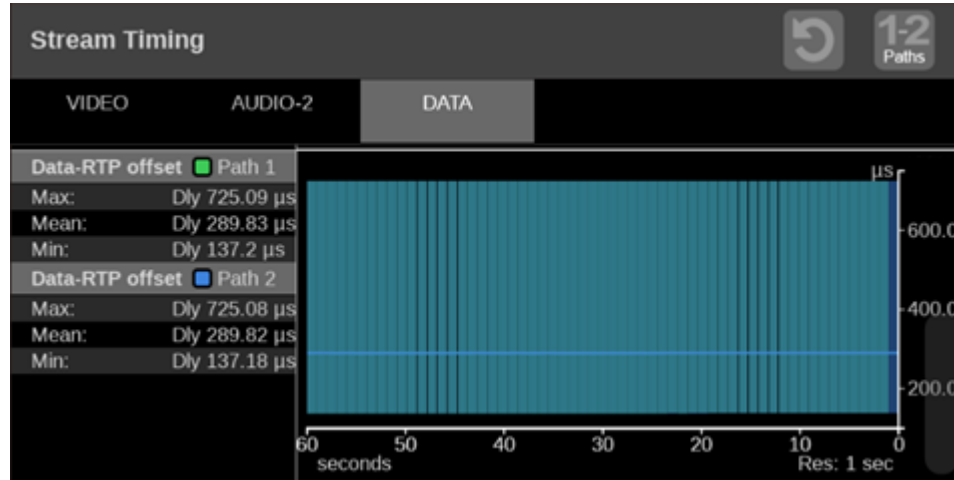

IP Generator Application

The IP Generator application provides ST2110 -20/-30 with ST2022-7 test signals which can be used to check the receiver device and the signal path.

Note: The IP Generator application requires Option MP2-GEN

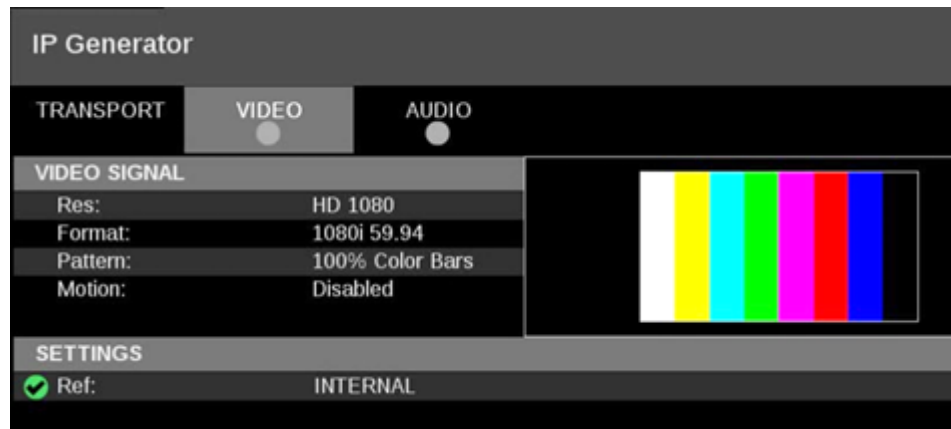

IP Generator Settings Menu

Open the IP Generator Settings menu:

1. Select the **Tiles** icon (🧩).
2. Select the tile with the IP Generator application.
3. Select the **Tile** icon (⚙️).

Note: The Move icon (↔️) is in the settings menu header. Select this icon to move the settings left of right.

Select **Save** to save your configuration.

The screenshot shows a settings window titled "Tile 4 IP Generator Settings". It has a close button (X) and a refresh button (↺). The window is divided into two main sections: "SETTINGS" and "TEST SIGNAL".

SETTINGS

- Enable IP ST2110 Generator:** A toggle switch currently set to "Disabled".
- Reference:** Two buttons, "Internal" (selected) and "PTP".

TEST SIGNAL

- Video/Audio:** Two buttons, "Video" (selected) and "Audio".
- Enable Video:** A toggle switch currently set to "Disabled".
- Resolution:** A dropdown menu showing "HD 1080".
- Format:** A dropdown menu showing "1080i 59.94".
- Pattern:** A dropdown menu showing "100% Color Bars".

At the bottom of the window are "Cancel" and "Save" buttons.

SETTINGS

- **Enable IP ST2110 Generator:** Select to set the IP ST2110 Generator to either Enabled or Disabled.
- **Reference:** Select to set the IP Generator reference to either Internal or PTP.

TEST SIGNAL

For video test signal options, select **Video**.

- **Enable Video:** This slider enables and disables the video test signal.
- **Resolution:** Select this drop-down list to choose a resolution.
- **Format:** Select this drop-down list to choose a format:
 - 525i 59.94: available for format SD only
 - 625i 50: available for format SD only
 - 720p 50: available for format HD 720 only
 - 720p 59.94: available for format HD 720 only
 - 720p 60: available for format HD 720 only
 - 1080i 50: available for format HD 1080
 - 1080p 50: available for format 3G LevelA
 - 1080i 59.94: available for format HD 1080
 - 1080p 59.94: available for format 3G LevelA

- 1080i 60: available for format HD 1080
- 1080p 60: available for format 3G LevelA
- Pattern: Select this drop-down list to choose from the patterns: Black or 100% Color Bars.
- Motion: Select this to enable or disable horizontal motion of the color bars.

Note: The Motion option is unavailable when Pattern is set to Black.

VIDEO TRANSPORT

- Packing Mode: Select this option to choose one of these packing modes:
 - Block: Block Packing Mode is based on 180 byte blocks and supports many formats.
 - General: General Packing Mode follows the open packing standards of RFC 4175.
- RTP Payload Type: Use this setting to give the generated IP stream a RTP Payload Type number between 96 to 127.

Note: Each generated IP stream must have a unique RTP Payload Type number.

- Packet Read Schedule (PRS): Select this option to choose one of these read schedules.
 - Gapped: Gapped PRS reads packets at an equally spaced sequence throughout the active field or frame interval and accounts for vertical blanking (gaps).
 - Narrow (Linear): Narrow (linear) PRS reads the packets at an equally spaced sequence throughout a video frame.

VIDEO PORT SFP+ 1 and SFP+ 2

Video port SFP 1 and SFP 2 can be Enabled or Disabled.

When enabled, each port is configured using the Destination Address and Destination Port.

Note: The Source IP Address, Source Port, Source MAC Address, and Destination MAC Address are automatically configured based on the Destination Address and Destination Port.

VIDEO PORT SFP+ 1	Enabled <input type="checkbox"/>
Source IP Address	172.21.54.17
Source Port	50020
Source MAC Address	08:00:11:22:5c:32
Destination Addr.	239.20.54.17
Destination Port	50020
Destination MAC Address	01:00:5e:14:36:11

Audio Test Signal Options

Under TEST SIGNAL select **Audio**.

TEST SIGNAL

For audio test signal options, select **Audio**.

These options are available under TEST SIGNAL.

- Enable Audio: Select to enable or disable the audio test signal.
- Channels: Select either 2 or 8 channels.
- Frequency: Select 1 kHz frequency or Multiple frequencies.
- Amplitude: Select from these options:
 - Mute: always available
 - -20 dBFS: available when Frequency is set to 1 kHz
 - -18 dBFS: available when Frequency is set to 1 kHz
 - Multiple: available when Frequency is set to Multiple
- Sample Depth (all Channels): This setting lists the sample depth of all channels.

The next table shows the audio test signal values in each channel when both Frequency and Amplitude, in the settings menu, are set to Multiple.

Multiple settings with Amperage and Frequencies levels per channel

Chan	Amp (dBFS)	Freq (Hz)
1	-18	240
2	-22	480
3	-20	360
4	-28	120
5	-24	600
6	-26	1200
7	-30	1800
8	-32	2400

VIDEO TRANSPORT

These options are available under VIDEO TRANSPORT.

- Packet Time: Select 125 μ s or 1 ms packet times.
- RTP Payload Type: Enter an RTP Payload Type number for the generated IP stream.

Note: Each generated IP stream must have a unique RTP Payload Type number.

AUDIO PORT SFP+ 1 and SFP+ 2

Audio port SFP 1 and SFP 2 can be Enabled or Disabled.

When enabled, each port is configured using the Destination Address and Destination Port.

Note: The Source IP Address, Source Port, Source MAC Address, and Destination MAC Address are automatically configured based on the Destination Address and Destination Port.

AUDIO PORT SFP+ 1 <input type="checkbox"/> Disabled	
Source IP Address	172.21.54.17
Source Port	<input type="text" value="50030"/>
Source MAC Address	08:00:11:22:5c:32
Destination Addr.	<input type="text" value="239.30.54.17"/>
Destination Port	<input type="text" value="50030"/>
Destination MAC Address	01:00:5e:1e:36:11

Elements of the IP Generator Display

Three display tabs provide information regarding the generated IP streams. Select one of the tabs to view the associated display.

TRANSPORT Tab Display

Select TRANSPORT to view the status of the generated IP streams.

IP Generator						
TRANSPORT	VIDEO	AUDIO				
<input checked="" type="radio"/>	<input type="radio"/>	<input type="radio"/>	<input type="radio"/>			
STREAM	PORT	PAYLD	DEST IP	SOURCE IP	D	
<input type="radio"/> S2110.20 P1	SFP1	96	239.20.54.17:50020	172.21.54.17:50020	0	
<input type="radio"/> S2110.20 P2	SFP2	96	239.20.54.17:50020	172.22.54.17:50020	0	
<input type="radio"/> S2110.30 P1	SFP1	97	239.30.54.17:50030	172.21.54.17:50030	0	
<input type="radio"/> S2110.30 P2	SFP2	97	239.30.54.17:50030	172.22.54.17:50030	0	

VIDEO Tab Display

Select VIDEO to view the settings of the generated video stream.



AUDIO Tab Display

Select AUDIO to view the settings of the generated audio stream.

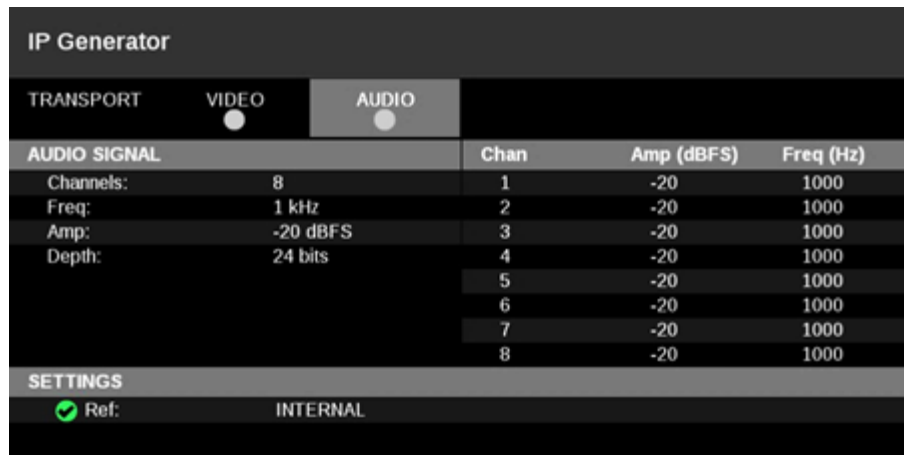

SDI Generator Application

The SDI Generator application provides SDI video signals that can be used to check the receiver device and the signal path.

Note: The SDI Generator application requires Option MP2-GEN.

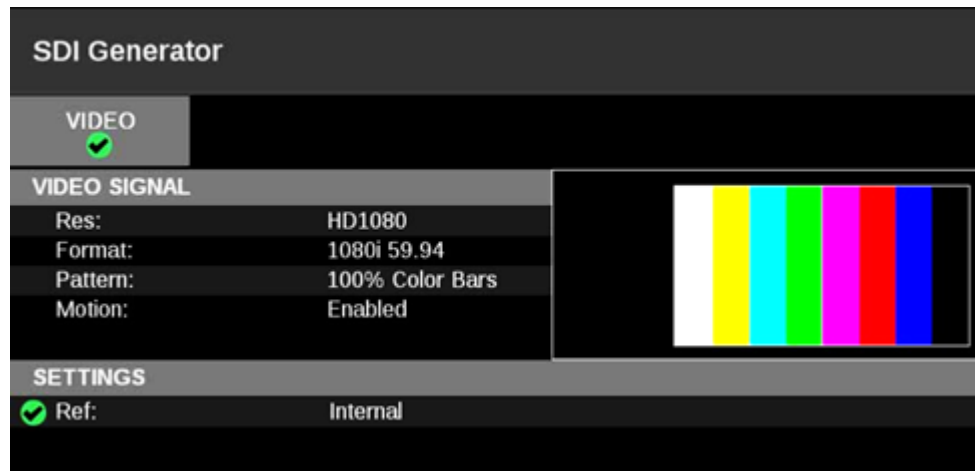

SDI Generator Settings Menu

Open the SDI Generator Settings menu:

1. Select the **Tiles** icon (🧩).
2. Select the tile with the SDI Generator application.
3. Select the **Tile** icon (⚙️).

Note: The Move icon (↔) is in the settings menu header. Select this icon to move the settings left of right.



SETTINGS

Enable SDI Generator

Select this to set the SDI Generator to Enabled or Disabled.

Reference

The SDI Generator uses an internal reference.

TEST SIGNAL Options

These options are available to configure the test signal.

Resolution

Select this drop-down list to choose the resolution.

Format

Select this drop-down list to choose from these formats:

- 525i 59.94: available for format SD only
- 625i 50: available for format SD only
- 720p 50: available for format HD 720 only
- 720p 59.94: available for format HD 720 only
- 720p 60: available for format HD 720 only
- 1080i 50: available for format HD 1080 only
- 1080p 50: available for format 3G LevelA or 3G LevelB only

- 1080i 59.94: available for format HD 1080 only
- 1080p 59.94: available for format 3G LevelA or 3G LevelB only
- 1080i 60: available for format HD 1080 only
- 1080p 60: available for format 3G LevelA or 3G LevelB only
- 3840p 23.98: available for format 6G UHD only
- 3840p 24: available for format 6G UHD only
- 3840p 25: available for format 6G UHD only
- 3840p 29.97: available for format 6G UHD only
- 3840p 30: available for format 6G UHD only
- 3840p 50: available for format 12G UHD only
- 3840p 59.94: available for format 12G UHD only
- 3840p 60: available for format 12G UHD only

Pattern

The only pattern available is 100% Color Bars.

Motion

Select to enable or disable horizontal motion of the color bars.

Elements of the SDI Generator Display

Select the **VIDEO** tab to view the settings of the generated SDI stream.

Note: SDI audio and data generation is not yet available.

Datalist Application



Datalist allows you to see the digital data contained in SDI frames for HD, 3G Level A, and single link 12G formats so you can perform in-depth monitoring and analysis of incoming SDI data. 4K Quad Link signals can be monitored by looking at the individual links as separate inputs.

Note: Datalist requires software option MP2-ENG or MP2-QC.

Note: Deep color is not supported in the Datalist application. All other SDI applications support deep color.

Elements of the Datalist Display

Note: The display readouts only display when the tile is expanded to full screen.

The half-screen icon () expands the tile vertically. If the tile expands, it covers the tile above or below, depending on whether you are expanding the top or bottom tile. The quarter-screen icon () brings the tile back to its original size.

The Datalist display shows the digital data from the selected SDI input. It is updated approximately once per second and updating can be controlled by the Run/Pause button in the application banner.

While the application is running or paused, you can scroll through the SDI data using a touchscreen or mouse. Scroll vertically by touch-swipe or use the mouse scroll wheel.

Scroll horizontally by touch-swipe or click and drag with the mouse. Alternately, the navigation controls described in can be used.

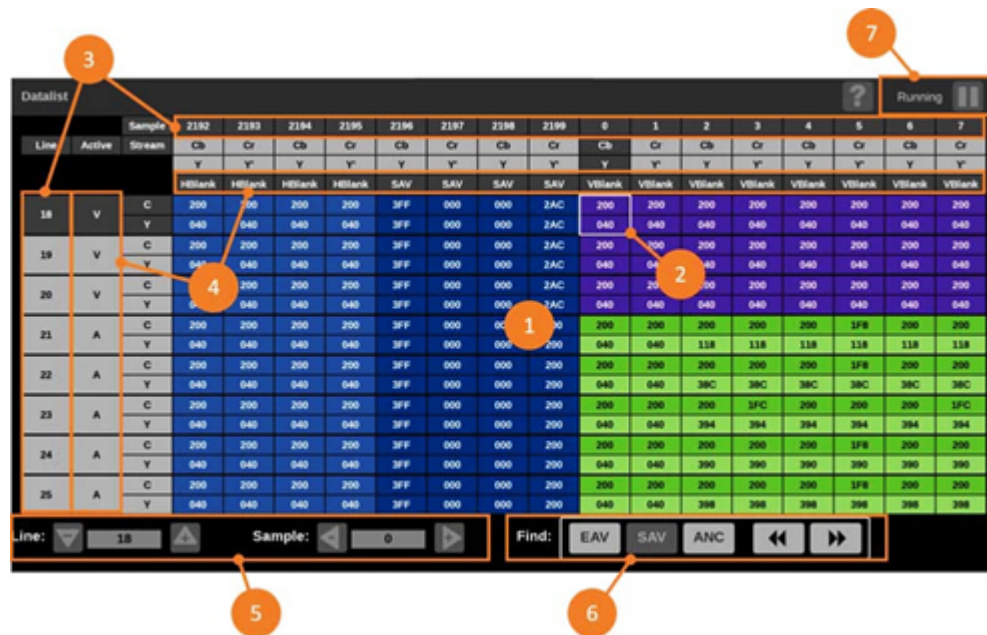

Item	Description
1	SDI frame data: The SDI frame data is color coded for easier identification. Select the ? key in the application banner for help in decoding the SDI data types.
2	Selected SDI sample: The SDI sample that is selected by the Line and Sample controls at the bottom of the application.
3	Line and Sample numbers
4	Line and Sample data types
5	Line and Sample selection: Use these controls to go to a specific sample and line. The number can be entered directly by selecting the current number; this displays a keyboard. Enter the line or sample number and select Enter to go to that location.
6	SDI frame shortcuts: Use these controls to go to the next EAV, SAV, and ANC location after the selected SDI sample. For example, to go to the next SAV location, select the SAV button and then select the fast forward button.
7	Run/Pause control: Select this button to run and pause the SDI frame updates. Pausing allows you to examine a single SDI frame in more detail.

ANC (Ancillary Data) Session Application

The ANC Data Session application allows you to examine all the ancillary data present in a signal. The instrument continually monitors the signal and tells you when changes in the presence of data occur.

Select the Clear icon (🗑️) to reset the monitoring session for both the WATCH LIST and the SCTE104 pages.

Note: PRISM monitors the first 4 links of the 8 logical SDI links in Quad Link 3G LB and Quad Link 12G.

WATCH LIST		SCTE104				
NAME	DID	SDID	LINK	LOCATION(S)	OCCURRENCE	NOTE
✓ S352M VPID	41	1	C	Line 10 Sample 1939	Field	89 ca 00 01
✓ Type 2	42	1	C	Line 10 Sample 1928	Field	
✓ S352M VPID	41	1	Y	Line 10 Sample 1939	Field	89 ca 00 01
✓ Type 2	42	1	Y	Line 10 Sample 1928	Field	
✓ S299-1 Ctrl Grp 1	E3	--	Y	Line 9 Sample 1928	Field	48kHz PP-- Frm

Note: A green checkmark in the WATCH LIST name column means data is being continuously received. A yellow exclamation mark means data has been received but it has stopped.

WATCHLIST Tab

Watchlist tab provides a list of the detected ANC data. It also reports the last detected time, so an infrequent ANC data, such as SCTE-104, can be monitored in the Occurrence column. The Line/Sample information, in conjunction with Datalist display, helps you diagnose the ANC data at the bit level.

DID: Data identifier of the packet; permissible values range from 1 to 0xFF (255) inclusive.

SDID: Secondary data identifier of the packet; permissible values range from 0 through 0xFF (255) inclusive.

LINK: Virtual link or stream the ANC data is present on.

LOCATION(S): Transport line number the ANC data is present on.

OCCURRENCE: Shows the last time a packet occurred.

Note: Shows the basic information about the Anc data, like timecode or summary of SCTE104.

SCTE104 Tab

The SCTE104 tab displays the Multiple Operations messages, and RTC / TC displays the reception time of the ANC packets with SCTE104 data. The user can review up to the last 10 messages to check the message sequence is correct.

Select the run button (▶) to start the data stream.

Select the pause button (⏸) to pause the data stream.

Note: When the run button (▶) is visible, it means data monitoring-collecting is paused. When the pause button (⏸) is visible, it means data collecting-monitoring is running.

Multiple Operation codes and the titles

Op code	Op title
0x0101	splice_request_data()
0x0102	splice_null_request_data()
0x0104	time_signal_request_data()
0x0109	insert_DTMF_descriptor_request_data()
0x010A	insert_avail_descriptor_request_data()
0x010B	insert_segmentation_descriptor_request_data()
0x010C	proprietary_command_request_data()

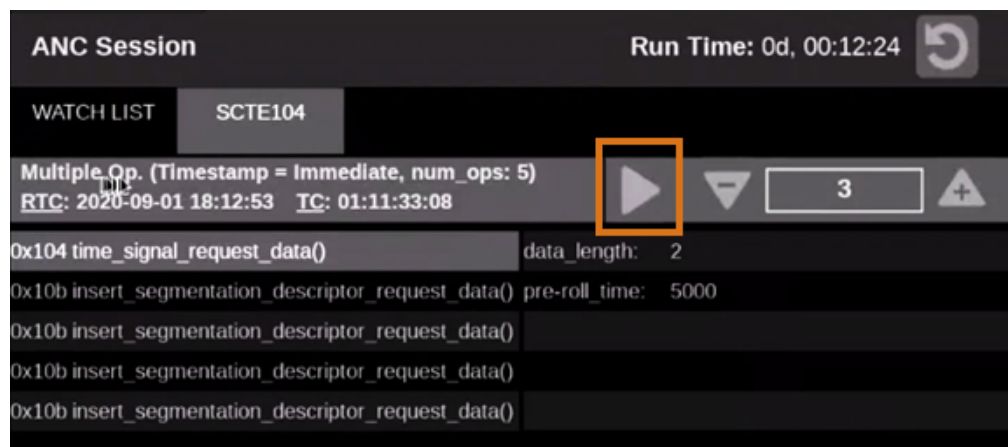

Note: The RTC (real-time clock) and TC (time code) numbers in the SCTE104 page match the RTC and TC in the PRISM status menu.

The number in the left column of the SCTE104 page is the number of operations received. Select the Plus icon (⊕) or Minus icon (⊖) to scroll through the list of up to the last 10 received messages.

Jitter Application

The Jitter Display application shows the wave shape of the jitter and allows you to view additional time-domain information, such as whether there are jitter components that are synchronous or nearly synchronous to the video line or frame.

Note: This application requires hardware option PHY and software Option MP2-FMT-4K to enable 12G-SDI. This application is only valid on SDI 1.

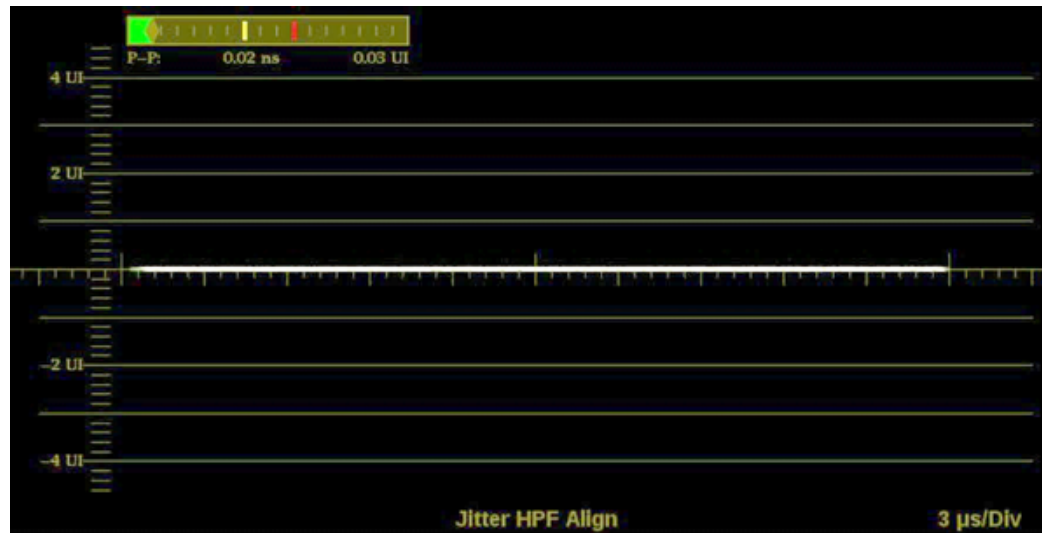

Jitter Display Settings Menu

Open the Jitter Display Settings menu:

1. Select the **Tiles** icon (🧩).
2. Select the tile with the Jitter Display application.
3. Select the **Tile** icon (⚙️).

Note: The Move icon (↔️) is in the settings menu header. Select this icon to move the settings left of right.



Jitter High-Pass Filter

Use the drop-down menu to select the high pass filter to Timing, Align, 10 Hz, 100 Hz, 1 kHz, 10 kHz, or 100 kHz.

Sweep Mode

Use the drop-down menu to select 1 Line, 2 Line, 1 Field, or 2 Field.

Jitter Meter

Select this to hide or show the jitter meter at the top of the display.

Note: Eye measurements are displayed when the Jitter Display application is in full screen mode.

Eye Application

The Eye Display presents an eye pattern diagram of the SDI signal to verify electrical characteristics of the SDI transport layer. Use this application to make automated eye measurements on SD, HD, and 4K SDI signals.

Note: This application requires hardware Option PHY and software option MP2-FMT-4K to enable 12G-SDI. This application is only valid on SDI 1.

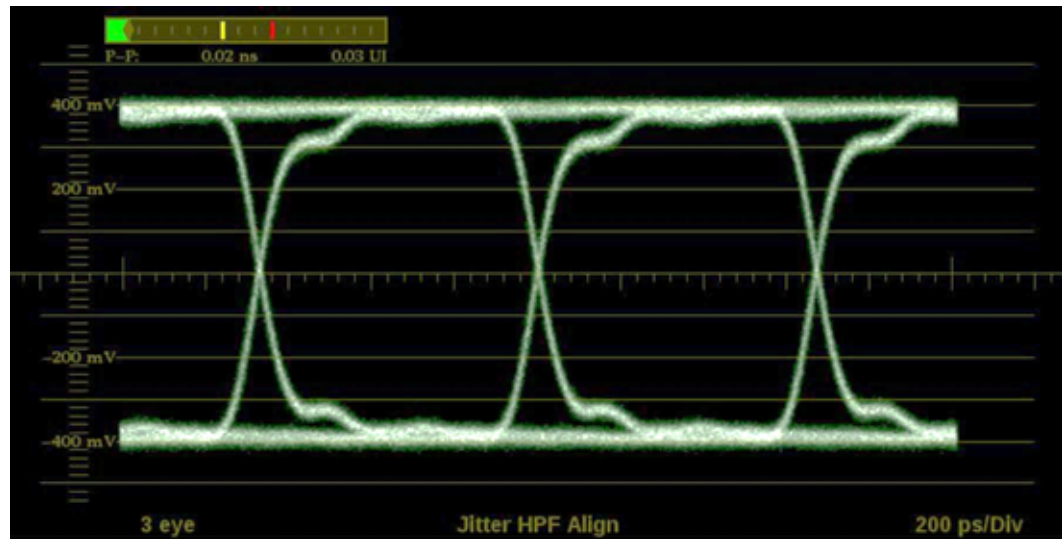

Eye Display Settings Menu

Open the Eye Display Settings menu:

1. Select the **Tiles** icon (🧩).
2. Select the tile with the Eye Display application.
3. Select the **Tile** icon (⚙️).

Note: The Move icon (↔️) is in the settings menu header. Select this icon to move the settings left of right.

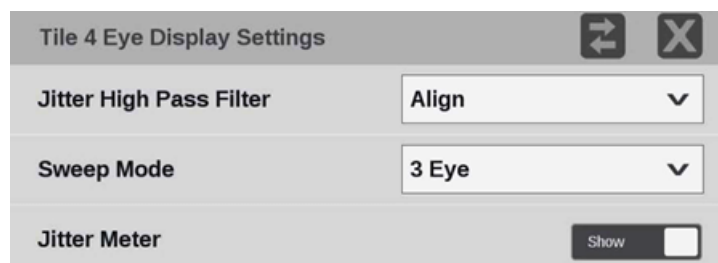

Jitter High Pass Filter

Use the drop-down menu to select the high pass filter to Timing, Align, 10 Hz, 100 Hz, 1 kHz, 10 kHz, or 100 kHz.

Note: For multi-piece displays, the filter setting applies to both pieces.

Sweep Mode

Use the drop-down menu to select 3 Eye, 20 Eye, 1 Field, or 2 Field.

Jitter Meter

Use the button to hide or show the jitter meter above the eye pattern.

Note: Eye measurements are displayed when the Eye Display application is in full screen mode.

Stop Display Application

The Stop Display provides a tool to monitor video signals with a variety of transfer functions in a consistent manner. It helps the Director of Photography (DP), Cinematographer, and Lighting Engineer to communicate to create a scene.

Note: Stop Display is enabled with Option MP2-PROD and is affected by the Gamma and Color Gamut settings. For additional information regarding these settings, refer to the [Configure and Select Signal Inputs](#) section.

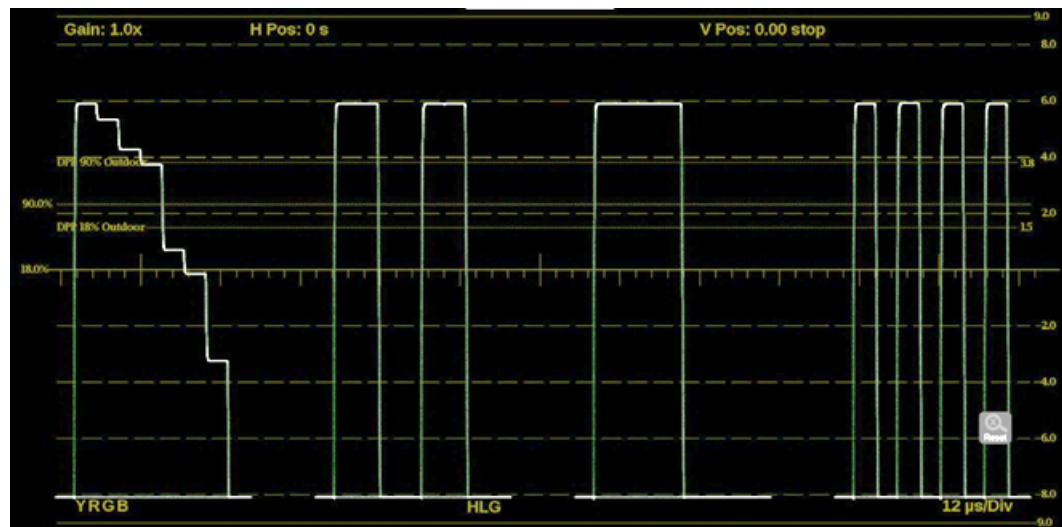

Stop Display Settings Menu

Open the Stop Display Settings menu:

1. Select the **Tiles** icon (🧩).
2. Select the tile with the Stop Display application.
3. Select the **Tile** icon (⚙️).

Note: The Move icon (↔) is in the settings menu header. Select this icon to move the settings left of right.

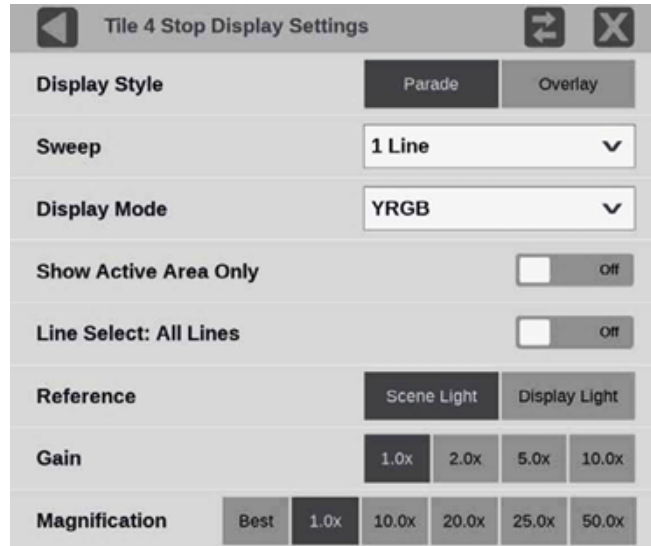

Display Style

Choose how the signal components are displayed in the active tile; use the Display Style buttons to select between:

- Parade: All the components are shown one beside the other.
- Overlay: All the components are drawn at the same location so they appear one on top of the other.

Sweep

Use the drop-down menu to select the waveforms to view between the lines or fields or make timing measurements on them. The available sweep options depend on which display style is active.

- When the Parade display style is active you can select from 1 line or 1 field.
- When Overlay display style is active you can select from 1 line, 2 line, 1 field, or 2 field.

Display Mode

Use the drop-down menu to select from these choices (only available while displaying SDI inputs) in the menu:

- Y: Displays the input as Luma (Y) components.
- RGB: Displays the input as Red (R), Green (G), and Blue (B) components.
- YRGB: Displays the input as Luma (Y), Red (R), Green (G), and Blue (B) components.

Show Active Area Only

Select to turn Show Active Area Only On or Off. When the option is On it removes the trace of vertical / horizontal blanking data.

Line Select

Choose the picture lines to monitor in the display. Either All Lines or 1 Line can be selected.

If 1 Line is selected, the display only shows results for the selected line in the picture. The line can be selected using the on-screen tools; see [Line Select Function](#). Or the line can be selected directly on the Picture.

Reference

Choose between Scene Light (Stops) and Display Light (Nits).

Gain

Select to change the gain to x1, x2, x5, or x10.

Magnification

Change the magnification to Best View, x1, x10, x20, x25, or x50.

Stop Display Application On-screen Tools

You can change the gain, display mode, and sweep without opening the Stop Display settings menu through on-screen tools. Select the tool/button for the setting you want to adjust. All the available tools are located on the top and bottom of the display and are highlighted for a few seconds when the application is first opened or if you select anywhere in the middle of the application tile.

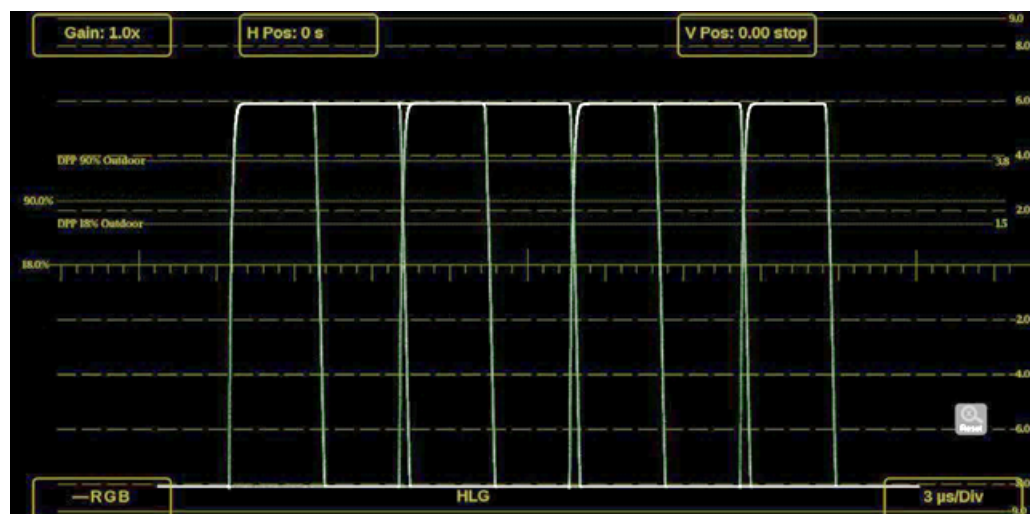

Gain

Increase or decrease the magnification of the trace display.

1. Select Gain to expand the available magnification options drop-down list.
2. Select one of the preset fixed-gain values from the drop-down list. Choose from 1.0x, 2.0x, 5.0x, or 10.0x.
3. Select the **Reset** icon () to reset the gain to 1.0x.

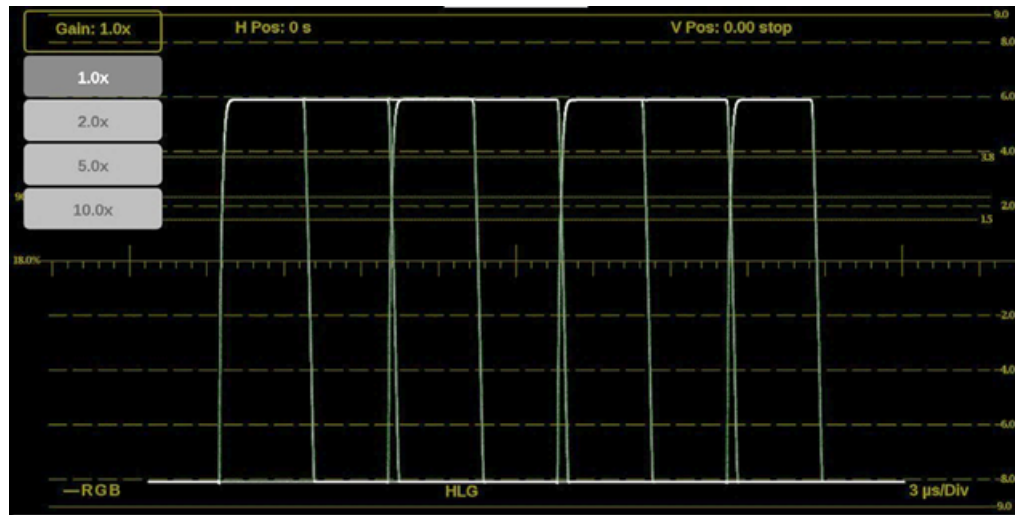

Horizontal and Vertical Position

Adjust the position of the trace display.

1. Select **H Pos** to allow adjustment of the horizontal trace.
 - Select and drag to move the trace on the touchscreen. This method can be performed without using the button.
 - Use a mouse scroll wheel to move the trace.
 - For incremental adjustments, select the plus or minus button to adjust the horizontal position.
 - Select the **Reset** icon (🔄) to reset the horizontal position adjustment to default.

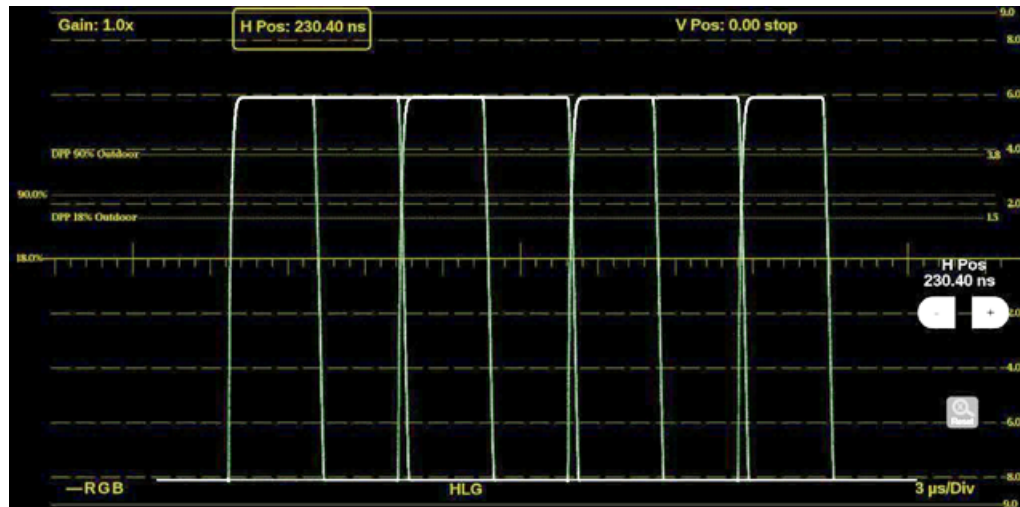

2. Select **V Pos** to allow adjustment of the vertical trace.
 - Select and drag to move the trace on the touchscreen. This method can be performed without using the button.
 - Use a mouse scroll wheel to move the trace.
 - For incremental adjustments, select the plus or minus button to adjust the vertical position.
 - Select the **Reset** icon (🔄) to reset the vertical position adjustment to default.



Display Mode

Change how the signal components are displayed.

1. Select the button in the bottom left corner of the application to expand the available display options.
2. Select the display style of the signal components. Use YRGB to display any combination of the Y, R, G, and B waveforms.

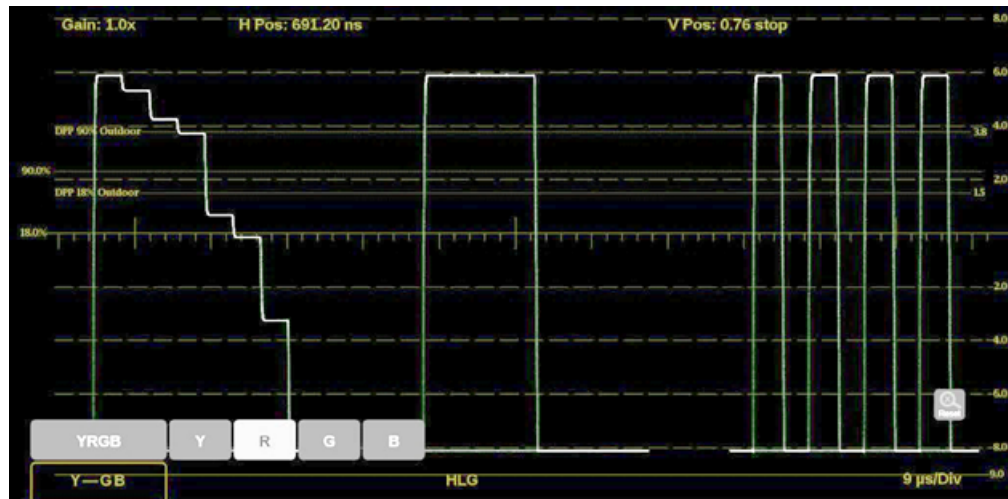

Display Format

Change the Display Style, Sweep, and Magnification of the Stop Display.

1. Select the button in the bottom right corner of the application to expand the available display format options.
2. Select the **Mag** option to adjust the magnification to Best View, x1, x10, x20, x25, or x50.

3. Select Parade or Overlay to switch between the Display Style options. The options depend on which Display Style is active.
 - When the Parade display style is active you can select from 1 line or 1 field.
 - When Overlay display style is active you can select from 1 line, 2 line, 1 field, or 2 field.

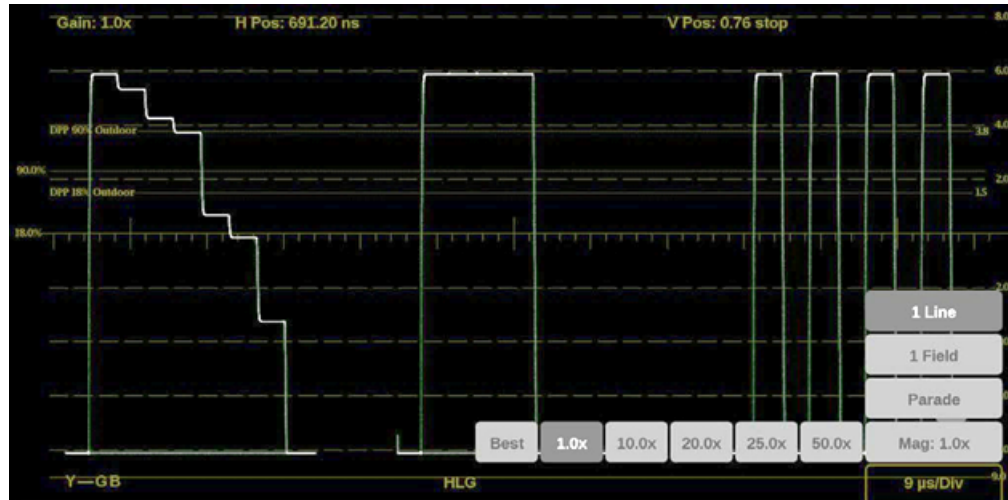

Line Select Function

Line Select allows you to select a single picture line to monitor in the display. By default All Lines is selected and all lines are monitored.

Note: The same line is selected in any trace display if line select is enabled.

To turn on Line Select (and choose the line to monitor):

1. Select the **Lines** at the bottom of the tile.
2. Select **1 Line**.
 - To scroll through lines, select the + and – buttons.
 - To enter a specific line to monitor:
 - select Line Sel. and enter the line on the keypad,
 - or
 - in the Picture application, use the line-select cursor (for active lines).

Depending on the resolution in the signal, the Line Select provides different information.

- If a signal is SD, HD, or 3G:
 - the Line number is the selected line, including vertical blanking,
 - if the signal is interlaced format, the Fields readout is below the Line number,
 - the Pic Line number is next to Line; the Pic Line is the active line number, or numbers, selected.

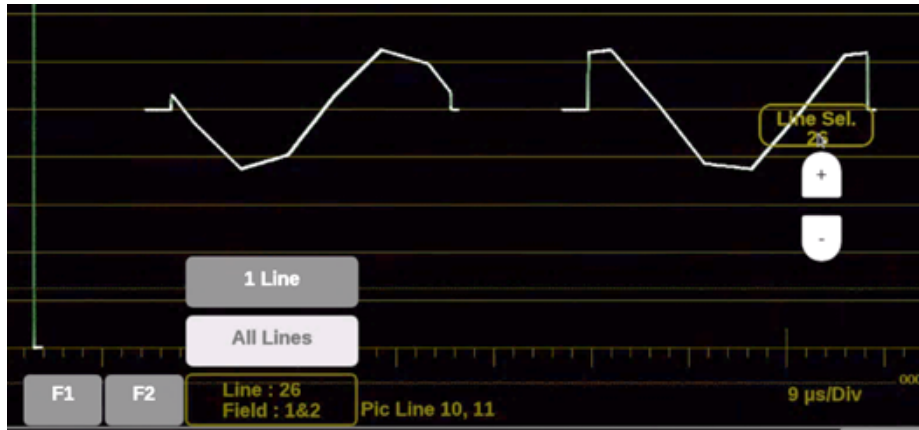

- If a signal is UHD or 4K:
 - the Line number is the selected raster line,
 - the SDI Line is the selected line including vertical blanking,
 - the link number appears below the SDI Line.

Note: In link, the letters (A-D) refers to the physical links. The numbers (1-4) refers to the virtual links. For example, A3/62 indicates it is physical link 1 and virtual link 3 (in a 2-sample interleave, 12G transport).

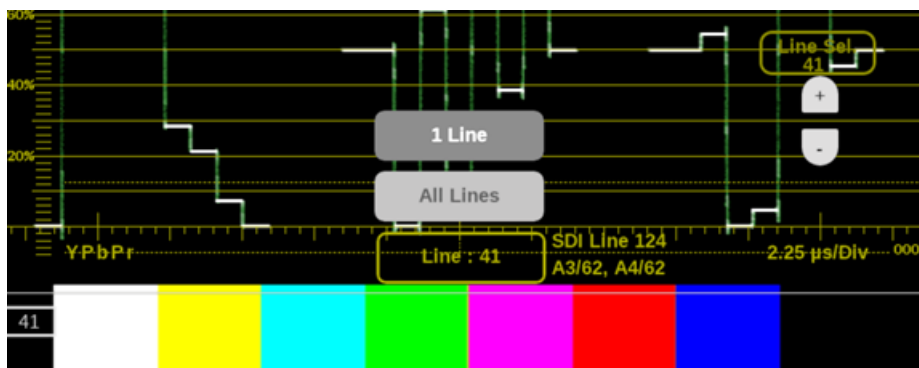

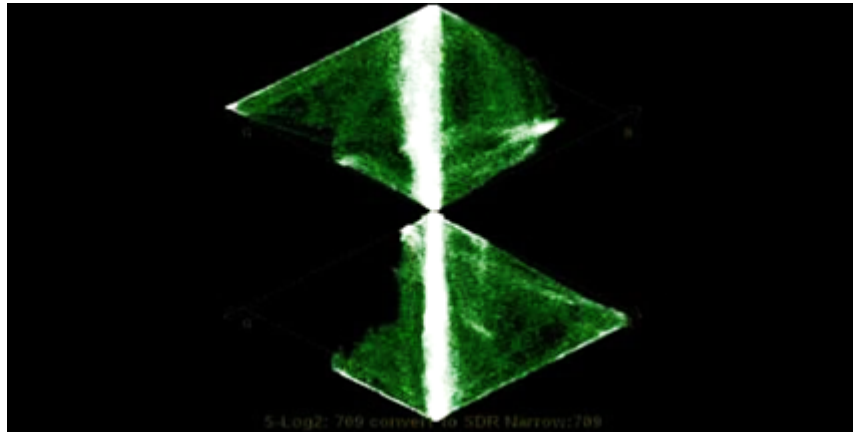

Diamond Application

The Diamond application provides a tool for white and black balancing at camera setup and for color gamut adjustment at color editing and QC. For additional information on how to use the Diamond Display application, refer to the [Checking Gamut](#) section.



Diamond Settings Menu

Open the Diamond Settings menu:

1. Select the **Tiles** icon ().
2. Select the tile with the Diamond application.
3. Select the **Tile** icon ().

Note: The Move icon () is in the settings menu header. Select this icon to move the settings left of right.

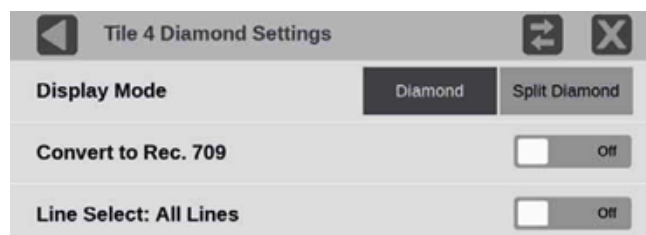

Display Mode

Select one of the options:

- **Diamond:** The normal Diamond display shows Gamut violations of the SDI input if translated to RGB color space.
- **Split Diamond:** The split Diamond display offsets the two halves of the Diamond to better see negative RGB Gamut errors.

Convert to Rec. 709

Turn this setting **On** to allow the trace displays to convert the Gamma and Color Gamut settings for the signal to SDR Narrow and BT. 709 (requires Option MP2-PROD).

Note: Convert to Rec. 709 auto converts to BT.709, otherwise the graticule selection must be manually changed (see [Configure Instrument for HDR/WCG Monitoring](#)). Convert to Rec. 709 mode is not supported for SD signals.

Line Select

Line Select allows you to choose the picture lines to monitor in the display. Either All Lines or 1 Line can be selected.

If 1 Line is selected then the display only shows results for the selected line in the picture. The line can be selected using the on-screen tools; see [Line Select Function](#). Or the line can be selected directly on the Picture.

Checking Gamut

The diamond display effectively shows how the R, G, and B signals relate. The Diamond display is a good tool for detecting gamut errors.

To form the diamond display, the instrument converts the Y, Pb, and Pr components recovered from the serial signal to R, G, and B. To predictably display all three components, they must lie between peak white, 700 mV, and black, 0 V.

For a signal to be in gamut, all signal vectors must lie within the G-B and G-R diamonds. Conversely, if a signal vector extends outside the diamond, it is out of gamut. The direction of an excursion out of gamut indicates which signal is excessive. Errors in green amplitude affect both diamonds equally, while blue amplitude errors affect only the top diamond and red errors affect only the bottom diamond.

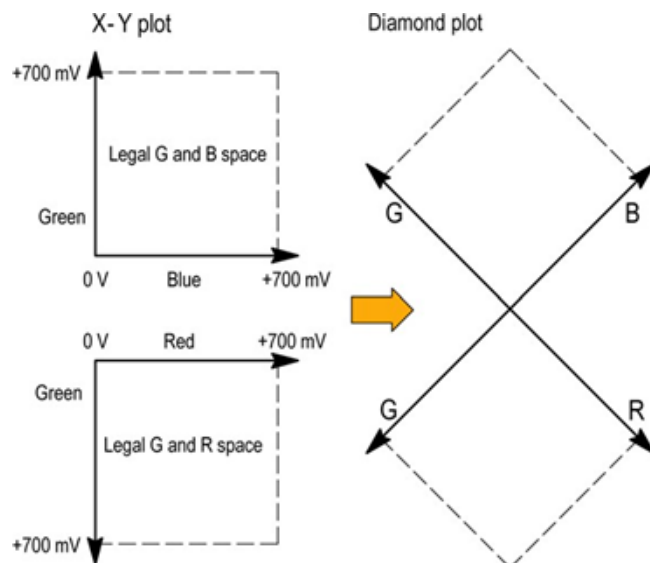

Compare the signal to the display to determine out-of-gamut components. Be aware of these details:

- The intensity of a vector indicates its duration.
- A momentary out-of-gamut condition appears as a faint trace. Long duration violations show as a bright trace.

When evaluating out-of-gamut components, consider:

- Example A:
R - Ok
G > 700 mV
B - Ok
- Example B:
R - Ok
G - Ok
B > 700 mV
- Example C:
R - Ok
G - Ok, 350 mV
B < 0 mV

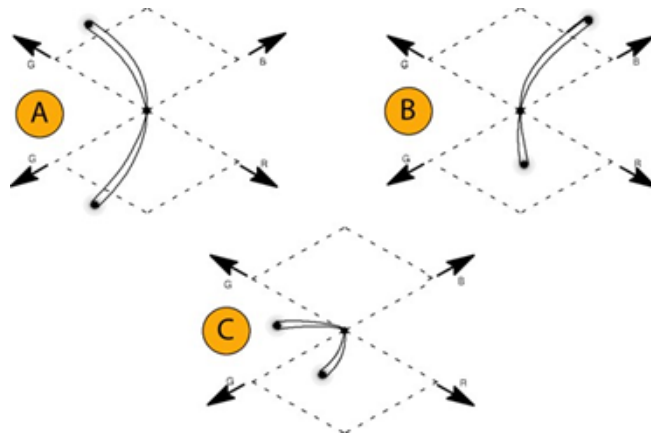

Note: Bending of the transitions indicates timing delays. When a color bar signal is applied, the vertical axis becomes an indicator of delay errors. Monochrome signals appear as vertical lines. Nonlinear component processing, such as from a gamma corrector that alters white balance, can cause deviations along the vertical axis.

Diamond Application On-screen Tools

Line Select Function

Line Select allows you to select a single picture line to monitor in the display. By default All Lines is selected and all lines are monitored.

Note: The same line is selected in any trace display if line select is enabled.

To turn on Line Select (and choose the line to monitor):

1. Select the **Lines** button at the bottom of the tile.
2. Select **1 Line**.
 - To scroll through lines, select the + and – buttons.
 - To enter a specific line to monitor:
 - select **Line Sel.** and enter the line on the keypad,
 - or
 - in the Picture application, use the line-select cursor (for active lines).

Depending on the resolution in the signal, the Line Select provides different information.

- If a signal is SD, HD, or 3G:
 - the *Line* number is the selected line, including vertical blanking,
 - if the signal is interlaced format, the *Fields* readout is below the Line number,
 - the *Pic Line* number is next to Line; the Pic Line is the active line number, or numbers, selected.

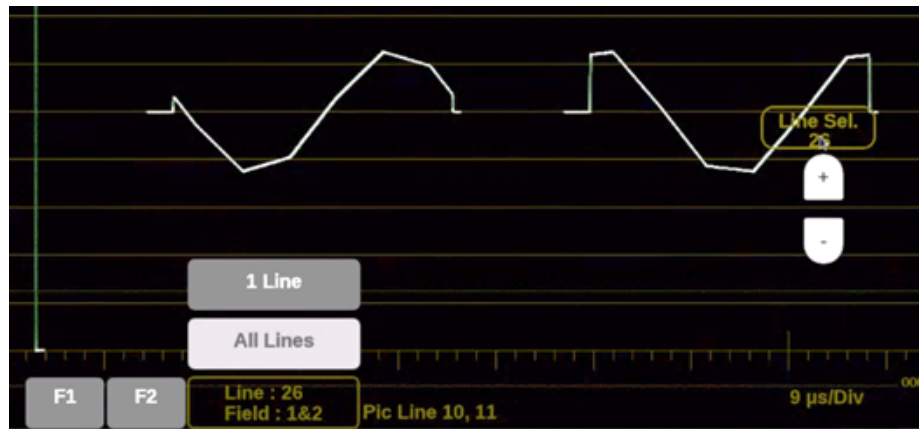

- If a signal is UHD or 4K:
 - the *Line* number is the selected raster line,
 - the *SDI Line* is the selected line including vertical blanking,
 - the *link* number appears below the SDI Line.

Note: In link, the letters (A-D) refers to the physical links. The numbers (1-4) refers to the virtual links. For example, A3/62 indicates it is physical link 1 and virtual link 3 (in a 2-sample interleave, 12G transport).

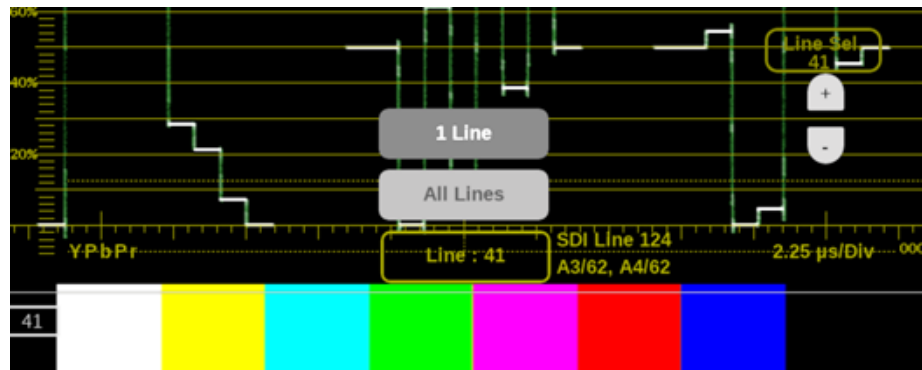

Lightning Application

The Lightning application shows luma and chroma amplitudes and helps verify component timing using a color-bar signal. Using a test signal in component format, this display helps make precise, accurate measurements of inter-channel amplitude and timing.

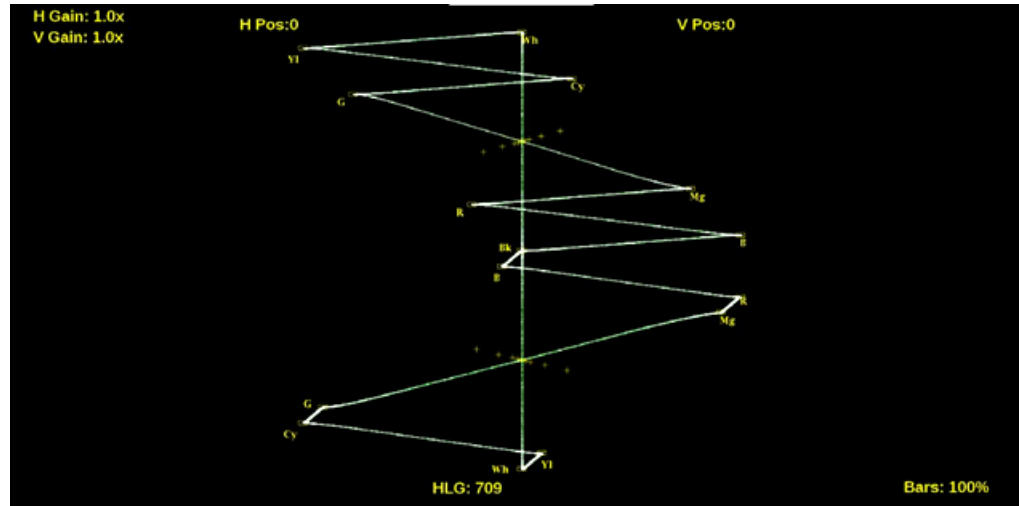

Lightning Settings Menu

Open the Lightning Settings menu:

1. Select the **Tiles** icon (🧩).
2. Select the tile with the Waveform application.
3. Select the **Tile** icon (⚙️).

Note: The Move icon (↔️) is in the settings menu header. Select this icon to move the settings left of right.



Bar Targets

Change the bar targets to either 75% or 100%.

V Gain

Change the vertical gain by x1, x2, x5, or x10 magnification.

H Gain

Change the horizontal gain by x1, x2, x5, or x10 magnification.

Convert to Rec. 709

Turn this setting On to allow the trace displays to convert the Gamma and Color Gamut settings for the signal to SDR Narrow and BT. 709 (requires Option MP2-PROD).

Note: *Convert to Rec. 709 auto converts to BT.709, otherwise the graticule selection must be manually changed. See [Configure Instrument for HDR/WCG Monitoring](#). Convert to Rec. 709 mode is not supported for SD signals.*

Line Select

Line Select allows you to choose the picture lines to monitor in the display. Either All Lines or 1 Line can be selected.

If 1 Line is selected, the display only shows results for the selected line in the picture. The line can be selected using the on-screen tools; see [Line Select Function](#). Or the line can be selected directly on the Picture.

Lightning Application On-screen Tools

You can change the horizontal gain, vertical gain, horizontal position, vertical position, and bar targets without opening up the Vector Settings menu through on-screen tools. Select the tool/button for the setting you want to adjust. All the available tools are located on the top and bottom of the display and are highlighted for a few seconds when the application is first opened or if you select anywhere in the middle of the application tile.

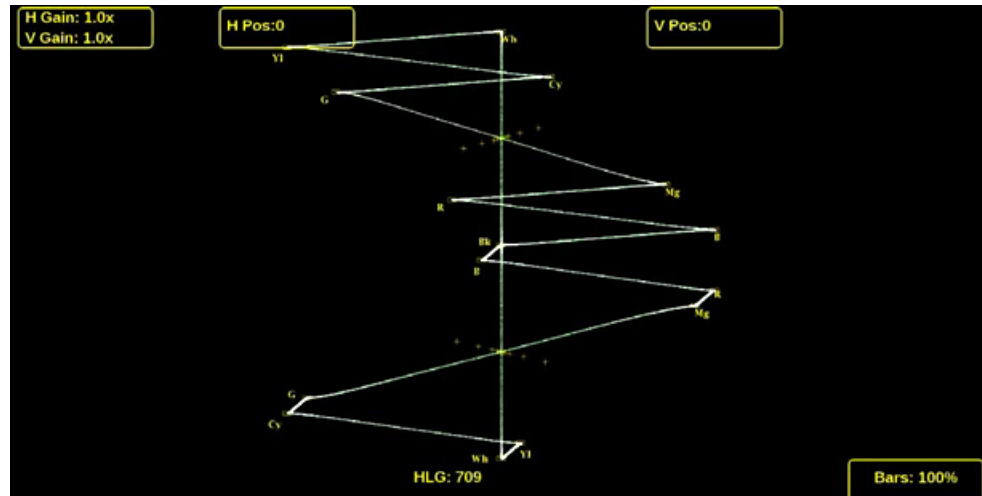

Horizontal and Vertical Gain

Increase or decrease the magnification of the horizontal and vertical trace displays.

1. Select the button in the top left corner to expand the available options drop down list.
2. Select one of the preset magnifications for fixed horizontal and vertical gain using the H Gain and V Gain options.

3. Select Variable Gain; select VAR: Off to VAR: H or VAR: V.

- Select **VAR: H** to change the horizontal gain in increments.
- Select **VAR: V** to change the vertical gain. Variable gain allows you flexibility in changing the gain factor between 0.5x to 20.0x.

The limits of the variable gain change depending on the gain factor you select.

- 1.0x has a range of 0.25x to 2.00x gain.
- 2.0x has a range of 0.50x to 4.00x gain.
- 5.0x has a range of 1.25x to 10.00x gain.
- 10.0x has a range of 2.50x to 20.00x gain

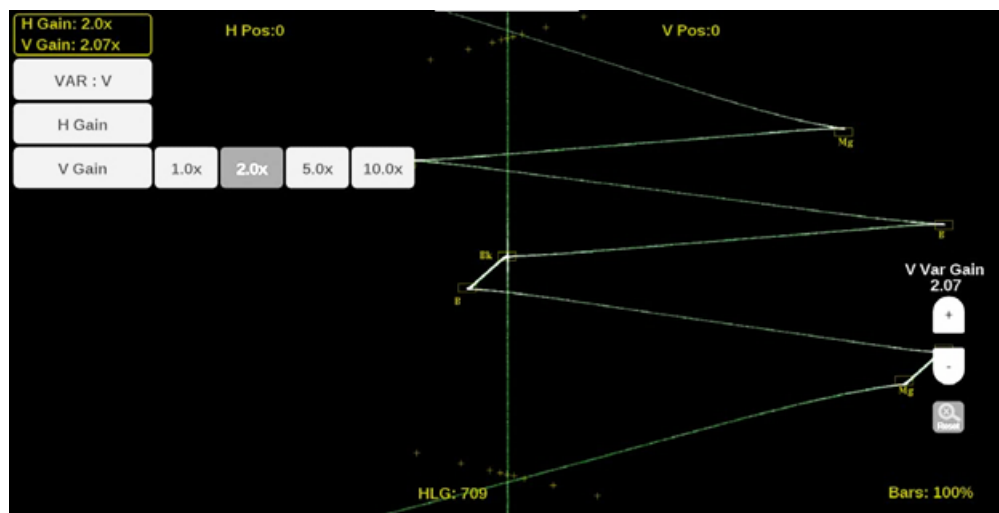
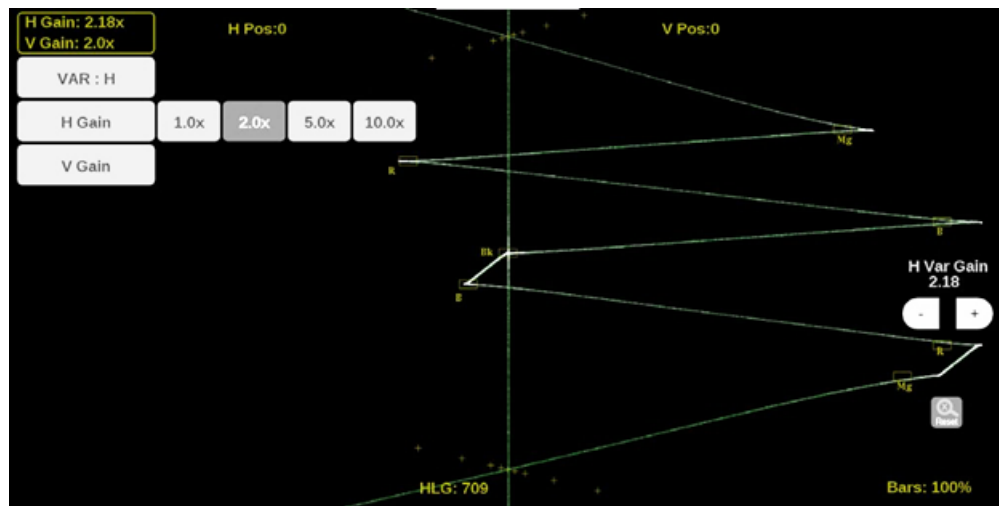

To adjust the gain:

- With a touchscreen, use a pinch gesture to change the scale of the trace for large incremental changes.

- For incremental adjustments, select the plus or minus button.
- The scroll wheel on a mouse can adjust the variable gain.
- Select the **Reset** icon () to remove variable gain adjustments.

Horizontal and Vertical Position

Adjust the position of the trace display.

1. Select the **H Pos** button to allow adjustment of the horizontal trace.
 - Select and drag to move the trace on the touchscreen. This method can be performed without using the button.
 - Use a mouse scroll wheel to move the trace.
 - For incremental adjustments, use the plus or minus button to adjust the horizontal position.
 - Select the **Reset** icon () to reset the horizontal position adjustment to default.

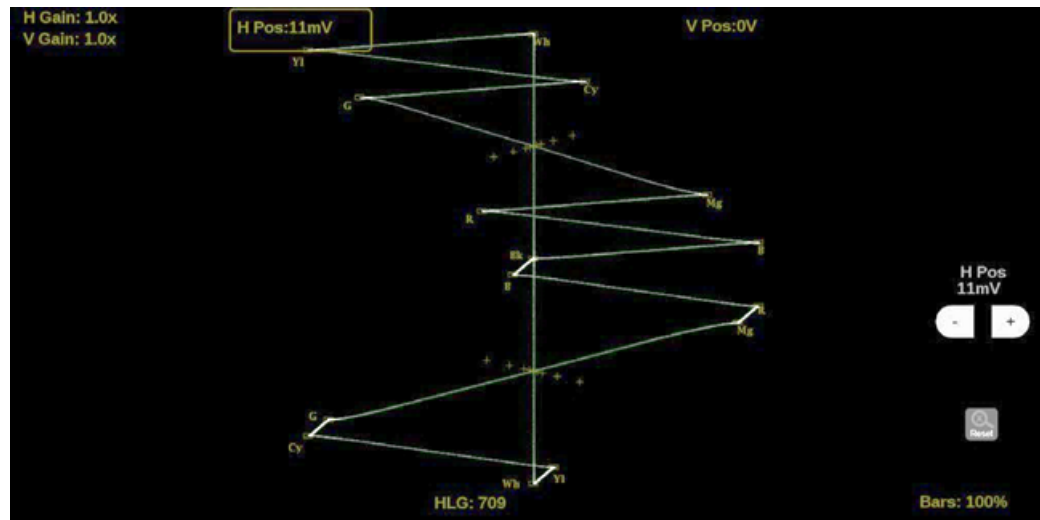

2. Select the **V Pos** button to allow adjustment of the vertical trace.
 - Select and drag to move the trace on the touchscreen. This method can be performed without using the button.
 - Use a mouse scroll wheel to move the trace.
 - For incremental adjustments, use the plus or minus button to adjust the vertical position.
 - Select the **Reset** icon (🔄) to reset the vertical position adjustment to default.

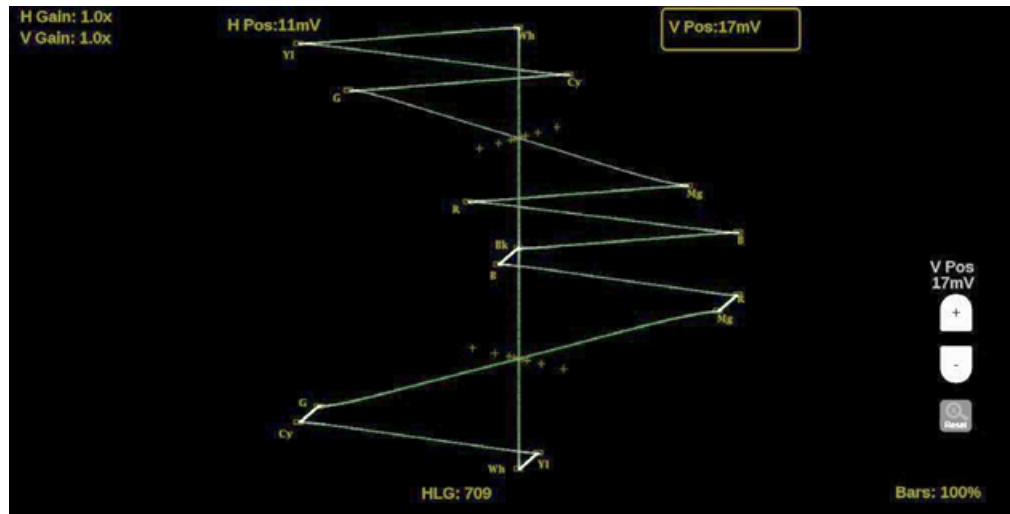

Bar Targets

Change the scaling of the Lightning Display.

1. Select **Bars** in the bottom right corner of the application to expand the available options.
2. Select 75% or 100% scaling.

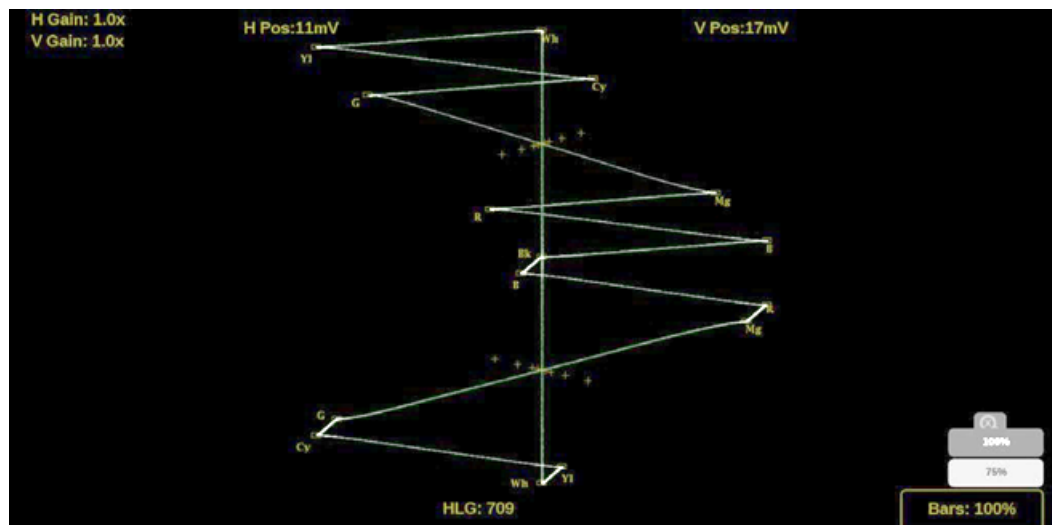

Line Select Function

Line Select allows you to select a single picture line to monitor in the display. By default All Lines is selected and all lines are monitored.

Note: The same line is selected in any trace display if line select is enabled.

To turn on Line Select (and choose the line to monitor):

1. Select the **Lines** button at the bottom of the tile.
2. Select **1 Line**.
 - To scroll through lines, select the + and – buttons.
 - To enter a specific line to monitor:
 - select Line Sel. and enter the line on the keypad,
 - or
 - in the Picture application, use the line-select cursor (for active lines).

Depending on the resolution in the signal, the Line Select provides different information.

- If a signal is SD, HD, or 3G:
 - the *Line* number is the selected line, including vertical blanking,
 - if the signal is interlaced format, the *Fields* readout is below the Line number,
 - the *Pic Line* number is next to Line; the Pic Line is the active line number, or numbers, selected.

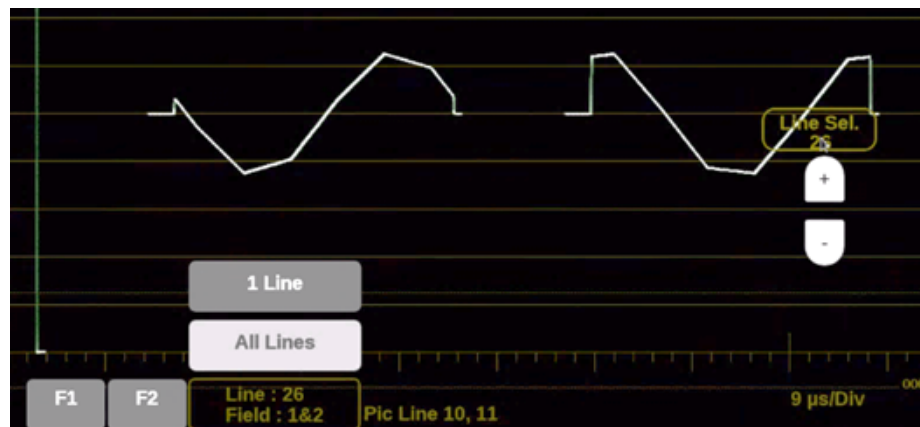

- If a signal is UHD or 4K:
 - the *Line* number is the selected raster line,
 - the *SDI Line* is the selected line including vertical blanking,
 - the *link* number appears below the SDI Line.

Note: In link, the letters (A-D) refers to the physical links. The numbers (1-4) refers to the virtual links. For example, A3/62 indicates it is physical link 1 and virtual link 3 (in a 2-sample interleave, 12G transport).

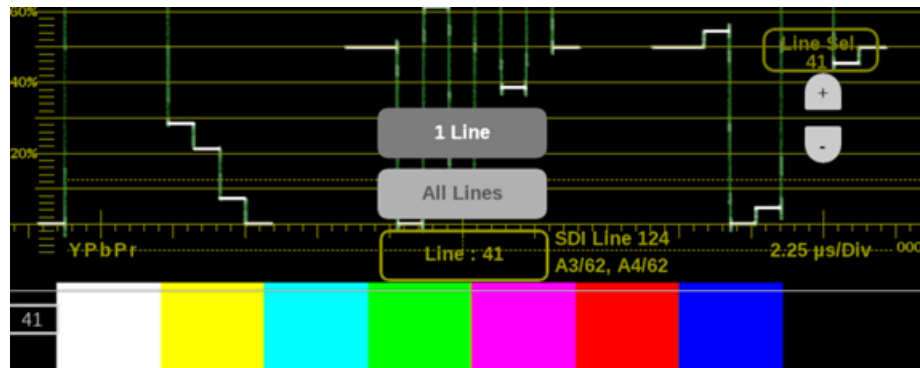

CIE Application

The CIE application shows video data as it is plotted in a 1931 or 1976 CIE diagram. CIE diagrams are used to check the chromaticity of the video signal and determine compliance to the standard color Gamut limits shown on the CIE diagram. In addition to the BT.2020, P3, and Rec. 709 limits shown, the D65 white point is also indicated.

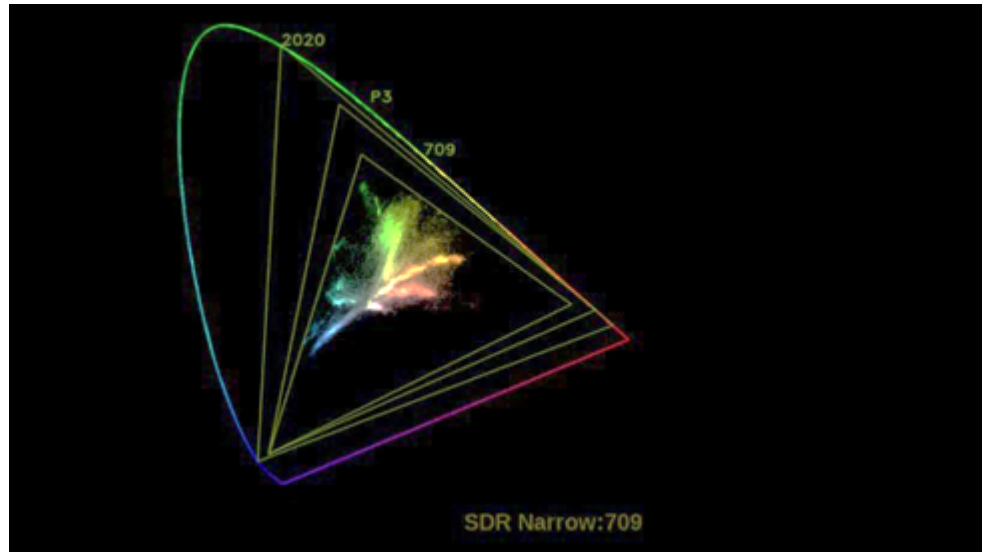

CIE Settings Menu

Open the CIE Settings menu:

1. Select the **Tiles** icon (🧩).
2. Select the tile with the CIE application.
3. Select the **Tile** icon (⚙️).

Note: The Move icon (↔️) is in the settings menu header. Select this icon to move the settings left or right.

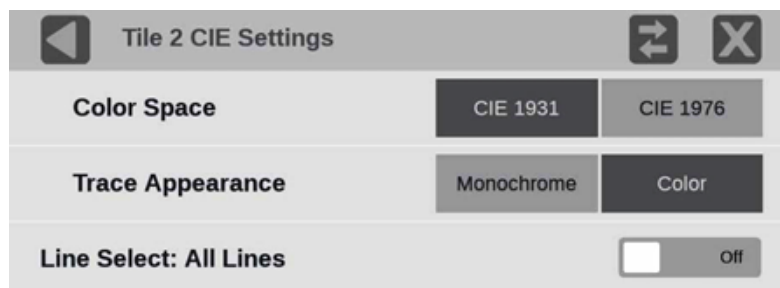

Color Space

Select either CIE 1931 or CIE 1976 diagrams.

Trace Appearance

You can plot the video data on the CIE display in either Monochrome or Color. If Color is selected, the plotted video data is colored with the corresponding CIE diagram colors. If Color is not selected, the plotted video data is gray.

Line Select

Line Select allows you to choose the picture lines to monitor in the display. Either All Lines or 1 Line can be selected.

If **1 Line** is selected, the display only shows results for the selected line in the picture. The line can be selected using the on-screen tools; see [Line Select Function](#). Or the line can be selected directly on the Picture.

CIE Application On-screen Tools

Line Select Function

Line Select allows you to select a single picture line to monitor in the display. By default All Lines is selected and all lines are monitored.

Note: The same line is selected in any trace display if line select is enabled.

To turn on Line Select (and choose the line to monitor):

1. Select the **Lines** button at the bottom of the tile.

2. Select 1 Line.

- To scroll through lines, select the + and – buttons.
- To enter a specific line to monitor:
 - select **Line Sel.** and enter the line on the keypad,
 - or
 - in the Picture application, use the line-select cursor (for active lines).

Depending on the resolution in the signal, the Line Select provides different information.

- If a signal is SD, HD, 3G:
 - the *Line* number is the selected line, including vertical blanking,
 - if the signal is interlaced format, the *Fields* readout is below the Line number,
 - the *Pic Line* number is next to Line; the Pic Line is the active line number, or numbers, selected.

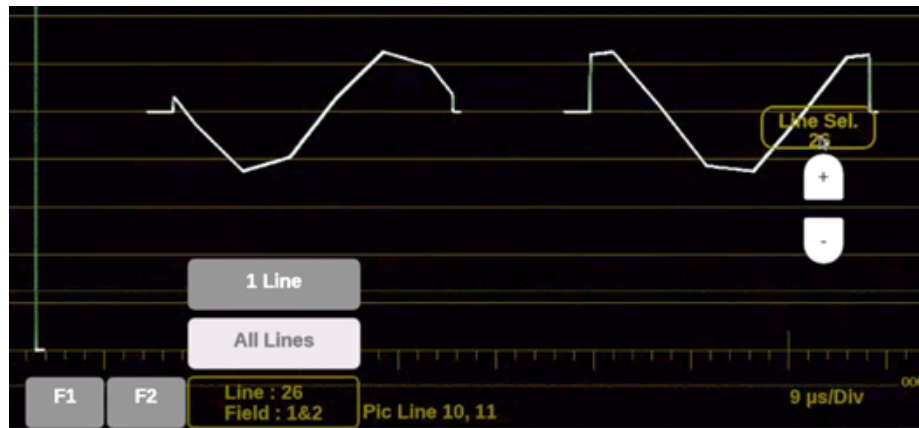

- If a signal is UHD, 4K:
 - the *Line* number is the selected raster line,
 - the *SDI Line* is the selected line including vertical blanking,
 - the *link* number appears below the SDI Line.

Note: In link, the letters (A-D) refers to the physical links. The numbers (1-4) refers to the virtual links. For example, A3/62 indicates it is physical link 1 and virtual link 3 (in a 2-sample interleave, 12G transport).

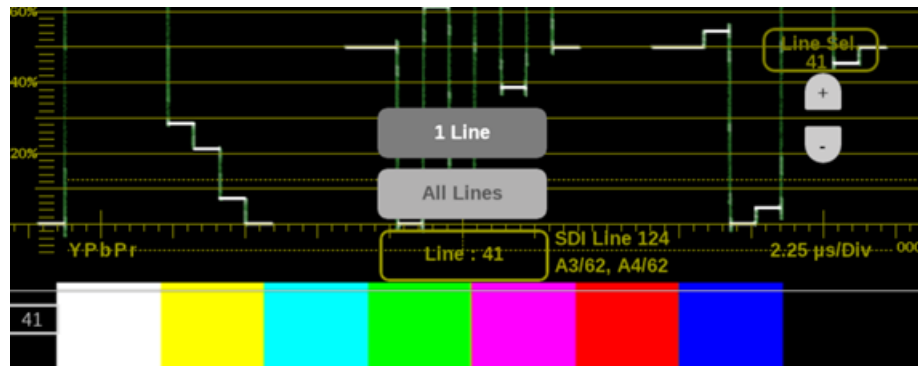

Dolby Status Application

Dolby Status supports all Dolby metadata for the currently monitored input can be viewed in the Dolby Status application. The application tile indicates if Dolby audio is not available in the currently monitored input.

Note: The Dolby Status application requires software options MP2-AUD or MP2-DLBY.

If your instrument has Dolby monitoring capabilities, it can decode and monitor audio signals that are based on Dolby digital surround sound formats. These formats are Dolby D/D Plus (AC-3) compression (designed for distribution) and Dolby E compression (designed for production).

The next sample shows Dolby E data.

Dolby Status		Program 1	
Program Desc Text			
Dolby Format	Dolby E 16	Dolby Surround Mode	Yes
Channel Mode	3/2 L	Copyright Bit	Yes
Program Config	5.1	Original Bitstream	Yes
Metadata Source	VANC 45/01	DC Filter	Yes
Dolby Data Rate	Not specified	Lowpass Filter	Yes
Bitstream Mode	Complete Main	LFE Lowpass Filter	Yes
Dolby E Frame Rate	29.97 fps	Surround 3 dB Atten	No
Dolby E Frame Loc	L21 F1 s1937	Surround Phase Shift	Yes
DYNAMIC RANGE PARAMETERS		EXTENDED BSI	
Dialogue Level	-31 dB	Preferred Stereo Dmix	Lt/Rt
Program Loudness		Lt/Rt Center Mix Lvl	-3 dB
Average Loudness		Lt/Rt Surrnd Mix Lvl	-3 dB
Line Mode Cmpr	Disabled	Lo/Ro Center Mix Lvl	-3 dB
RF Mode Cmpr	Disabled	Lo/Ro Surrnd Mix Lvl	-3 dB
		Surround EX Mode	No
RF Overmod Prot	Disabled	Headphone Mode	Not Indicated
Center Mix Lvl	-3 dB	A/D Converter Type	STD
Surround Mix Lvl	-3 dB		
Mixing Level	Not Indicated	SMPTE Timecode	00:00:00:00
Room Type	Not Indicated		

The next sample shows Dolby D data.

Dolby Status		Program 1	
Dolby Format	Dolby D	Dolby Surround Mode	Unknown
Channel Mode	3/2 L	Copyright Bit	Yes
Metadata Source	AES Embedded 3-4	Original Bitstream	Yes
Dolby Data Rate	384 kbps		
Bitstream Mode	Complete Main		
Dolby Sample Rate	48 kHz		
DYNAMIC RANGE PARAMETERS		EXTENDED BSI	
Dialogue Level	-24 dB	Preferred Stereo Dmix	Not Indicated
Program Loudness		Lt/Rt Center Mix Lvl	-3 dB
Average Loudness		Lt/Rt Surrnd Mix Lvl	-3 dB
Line Mode Cmpr	Unknown	Lo/Ro Center Mix Lvl	-3 dB
RF Mode Cmpr	-0.28 dB	Lo/Ro Surrnd Mix Lvl	-3 dB
		Surround EX Mode	No
RF Overmod Prot	Disabled	Headphone Mode	Unknown
Center Mix Lvl	-3 dB	A/D Converter Type	STD
Surround Mix Lvl	-3 dB		
Mixing Level	105.00 dB	SMPTE Timecode	00:00:00:00
Room Type	Small Room		

Dolby Status Settings Menu

Open the Dolby Status Settings menu:

1. Select the **Tiles** icon (🧩).
2. Select the tile with the Dolby Status application.
3. Select the **Tile** icon (⚙️).

Note: The Move icon (↔️) is in the settings menu header. Select this icon to move the settings left of right.

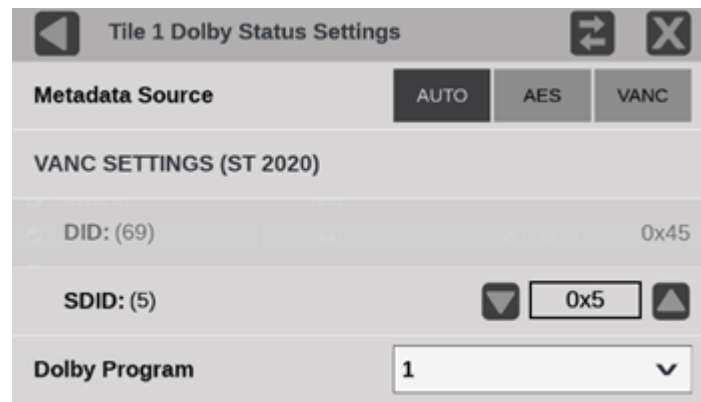

Metadata Source

Lets you select the source of the Dolby E metadata, either from the incoming Dolby E audio, if your instrument is decoding Dolby E audio, or VANC metadata if the Dolby E is externally decoded.

- **Auto:** Selects the Dolby E audio by default as the metadata source, if it is available. If Dolby E audio is not available, it uses VANC audio.

- **AES:** Selects the Dolby E audio as the metadata source. The Dolby Status application is blank if Dolby E is not being decoded.
- **VANC:** Selects the decodes and displays the VANC metadata source. The SDID must be properly selected.

DID

Data Identifier of the requested packet, it is set to 0x45 (69 decimal) and is not changeable.

SDID

Secondary Data Identifier of the requested packet, an SDID value of 01h is used when there is only one audio program associated with a video signal, and there is no intended association between VANC packets with an SDID value of 01h and a specific audio channel pair.

See Annex E for further information on how to assign SDID values.

Association between the first audio channel pair of an audio program and the SDID values

Audio Channel Pair	SDID
No association	01h
Channel pair 1/2	02h
Channel pair 3/4	03h
Channel pair 5/6	04h
Channel pair 7/8	05h
Channel pair 9/10	06h
Channel pair 11/12	07h
Channel pair 13/14	08h
Channel pair 15/16	09h

Annex E

Assigning SDID Values (Normative)

When multiple audio programs are carried by, or associated with, a single video signal, the SDID value is used to identify the VANC data packets carrying the audio metadata for each of the audio programs.

The audio channels making up an audio program are assigned to consecutively numbered or consecutively arranged audio channel pairs. The VANC packets carrying the audio metadata for a specific audio program are identified by setting the SDID

values of these packets to the value associated with the lowest numbered audio channel pair of the group of audio channel pairs carrying the complete audio program.

For example, if there is a six-channel program carried in the first three audio channel pairs and a stereo program carried by the fourth audio channel pair, then the VANC packets carrying the metadata for the six-channel program would have their SDID value set to 02h because the program starts in audio channel pair 1/2. The VANC packets carrying the metadata for the stereo program would have their SDID value set to 05h because the stereo program starts in audio channel pair 7/8.

Dolby Program

Use the drop-down menu to select the Dolby program number to monitor.

The Program number in the top right of the Dolby Status app border is the same as the Dolby Program number in the Dolby Status Settings. Select the arrow and select the number of the program to monitor.

Elements of the Dolby Status Display

This is a list of some of the elements in the Dolby Status application. For a complete list of the elements that might appear, see the Dolby Metadata Guide available at www.dolby.com.

Program Description Text

A 32-character ASCII text field used by the program author to describe the audio program; for example, the name of the program (Movie Channel Promo), the program source (Football Main Feed), or the program language (Danish).

Dolby Format

Indicates the Dolby Format. This indicator is also tied to the Dolby Format Error/Alarm: if the Alarm is asserted, the Dolby Format is displayed in red.

Channel Mode (or Audio Coding Mode)

Indicates the active channels within the encoded bit stream, representing it in a ratio, X/Y, where X is the number of front channels (Left, Center, Right) and Y is the number of rear (Surround) channels. If the LFE Channel is present, an L is appended at the end of the channel mode.

Program Configuration

Determines how the audio channels are grouped within a Dolby E bitstream. Up to eight channels can be grouped together in individual programs, where each program contains its own metadata.

Metadata Source

Indicates the input from which the Dolby Content is sourced.

Dolby Data Rate

For Dolby E it indicates the data rate that would be used to encode a Dolby Digital bitstream.

Bitstream Mode

Describes the audio service contained within the Dolby Digital bitstream. A complete audio program may consist of a main audio service (a complete mix of all the program audio), an associated audio service comprising a complete mix, or a main service combined with an associated service. For more information about possible values, see the instrument online help; when the Dolby Status display is active in a tile, select the HELP button.

Dolby E Frame Rate

Indicates the Dolby E frame rate. If Dolby Frame Rate is not the same as the video Frame Rate, the rate value is displayed in red.

Dolby E Frame Loc

Displays the location (line number and sample number) of the SMPTE337 preamble.

Dialogue Level

Represents the long-term, A-weighted average level of dialog within a presentation, $Leq(A)$.

PTP Operational Overview

This section provides an overview of PTP network operation. Not all of the functionality described is currently available in the PRISM monitor.

PTP Introduction

PTP Master Selection

In a PTP network, all the masters on the network are evaluated by the Best Master Clock Algorithm (BMCA). The BMCA runs on all devices, and chooses a master based on several parameters. Some of the parameters relate to clock quality; conversely the Priority 1 and Priority 2 parameters are set by the user to influence the choice of a master:

Note: The PRISM monitor has no role in setting the priority parameters or in providing information to the BMCA.

- **Priority 1:** This parameter defines which clocks are allowed to be considered as masters. To be considered as a master, the value should be set to 128 or less. Priority 1 is the first criteria in the BMCA, so if Priority 1 is set to a lower value than other devices on the system, then it is chosen even if the clock quality is poor. Typically, all the masters in a domain should have the same value for the Priority 1 parameter.
- **Priority 2:** This parameter is used to break the tie between masters that have the same clock quality. Several values may be used to define a hierarchy of devices. Most profiles use 128 as a default, so a value of 127 or lower would indicate a preferred master.
- The final tie-breaker in the BMCA is the clock ID. This is usually the MAC address so it provides a unique value by which the BMCA can choose.

Network Topology

In a typical IEEE1588 PTP network, many devices may be either masters or slaves. If the current master stops working, all the devices that are capable of being a master broadcast their clock quality and a new master is selected.

For video networks it may make sense to depart from the telecom-style PTP topology and dedicate devices to be only masters or slaves. This is the approach supported by the PRISM monitor, which allows for a more traditional primary and backup master structure controlling a range of slave devices. The BMCA is still used to select the active master and the network still takes the place of the ECO in the legacy Black-burst/Tri-level network. The PRISM monitor is a slave-only device.

Five Basic PTP Timing Messages

This section describes the five basic timing messages in a PTP system. Other messages are present in some instances. For example, grant requests and responses appear in unicast systems, and Type Length Value (TLV) management messages appear in SMPTE ST2059 profile systems.

Announce Message

The Announce message is sent by the master to advertise its capability. This message contains the clock quality and priority settings needed for the BMCA to evaluate which device is the best master.

Sync Message

The Sync message is sent by the master and is used to measure the propagation delay from the master to slave. The sync message may contain the timestamp indicating when it was sent, or that time may be in the Follow-up message. The receiver must timestamp the sync message upon receipt. These two time stamps are usually called t_1 and t_2 and provide the first delay measurement.

Follow-up Message

The Follow-up message is sent only in cases where the PTP network hardware is not capable of inserting the timestamp or corrections into the Sync message. (See [One-step and Two-step Operation](#).)

Delay Request Message

The Delay request is sent by the slave. The time it is sent is noted by the slave but is not included in the message. This time is usually called t_3 . When the delay request is received by the master, the master time stamps the receive time. This timestamp is usually called t_4 .

Delay Response Message

The Delay response is sent from the master to the slave. The response contains the t_4 time stamp from when the master received the delay request. After the slave receives the delay response, it has the second pair of time stamps needed to calculate the second delay measurement of the slave to master delay.

Message Timing

The illustration shows the relationships between the five PTP timing messages.

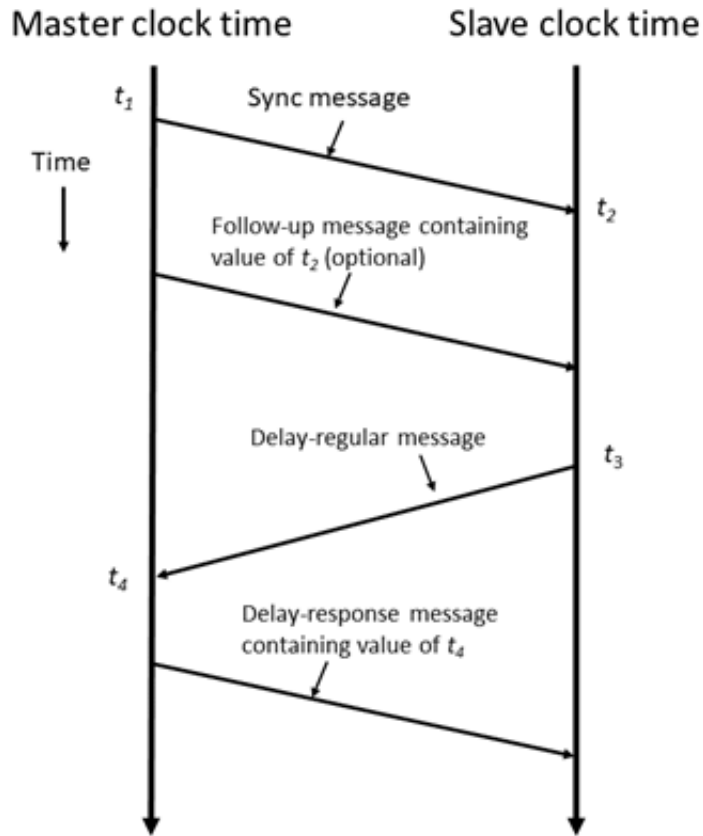

Profiles and Domains

Multiple domains and profiles can coexist on the same network.

Profiles

The IEEE1588 standard defines multiple parameters, such as the rates for Sync and Announce messages, and optional functions such as grandmaster clusters. Specific industries wanting to use PTP are encouraged to define their own “profile,” which allows the PTP standard to be tuned for specific applications. The profile defines the default and range of each parameter, and defines with options are required, allowed, or prohibited.

In the Prism monitor, the user should select the PTP profile (General, ST2059, or AES67). The user can then modify the profile parameters and save as part of an instrument preset. The allowed range of the parameters is restricted to that which is allowed for the selected profile type.

Domains

The IEEE1588 standard defines “domains,” which allow multiple PTP services to coexist simultaneously on one physical Ethernet connection. For example, on a given network one master and several slaves can be using domain 0 while a second master and other slaves are using domain 1. These two PTP services are independent. One use for this is to have masters on different domains provide PTP on different profiles. For example, domain 0 might be an AES67 profile, domain 1 could be a master using the AVB (802.1AS) profile, and domain 127 could be a master on the SMPTE ST2059 profile.

One-step and Two-step Operation

Some PTP messages have a time stamp associated with them. This time stamp indicates the time of the local clock when the message was sent or received. In some cases, the hardware is capable of embedding the time stamp in the message as it is sent. This is known as “one-step” mode because the message and its associated time are sent together.

In other cases, the hardware is not capable of inserting the time into the message, so instead it is sent in a second follow-up message. This is called “two-step” mode because there are two messages.

It is interesting to note that in End-to-End mode, only the Sync message is affected by the one-step and two-step setting since it is the only message that needs the transmit time stamp inserted. In a similar fashion, Peer-to-Peer mode has some messages that may require follow-up support.

The IEEE1588 standard specifies that all slaves are required to operate with either one-step or two-step message types. One type of device which often requires two-step operation is a Transparent Clock, since it has to calculate the residence time of a message and insert that time into the message or the follow-up message.

Multicast, Unicast, and Mixed Communication Modes

There are three basic message modes for PTP: Multicast, Unicast, and mixed Multicast and Unicast. For full Multicast or Unicast modes, all of the PTP messages are sent in the selected mode type.

For some profiles, such as some telecom profiles and the SMPTE ST2059 profile, a mixture of Multicast and Unicast are allowed. On the SMPTE profile unique mixed mode, the Announce and Sync messages are sent as multicast. However, the Delay Request and Delay Response messages are sent as Unicast.

Some points to understand about communication modes:

- Whatever mode is chosen, the master and slave must match or be compatible.
- Multicast and Mixed mode may need IGMP joins and leaves.
- Full Unicast must have the master address in all slave AMTs.
- Unicast without negotiation does not allow master to regulate load.
- Two masters can be used on different domains to serve slaves on different communication modes.

All of the master and slave devices on a given domain must use compatible communication modes. For most profiles, this means the master and slave communication modes need to match exactly. On the SMPTE profile, the Multicast and Mixed modes are compatible, so a master in any of these modes should work with a slave in any of those modes.

Multicast System Messages

Multicast messages are broadcast and so they can be received without knowing the address of the sender. This allows a slave to hook up to the network, receive the announce messages and discover the identity of the master. Multicast in some networks requires the devices to use IGMP to join and leave the multicast group.

In Multicast PTP systems, the master sets the rate of the announce and sync messages. The master also sends the maximum allowed delay request rate in the delay response message. Ideally, the slave uses that value to set the delay request rate although some slaves set this rate independently. The delay request rate is typically the same as the sync rate but may be higher or lower.

Unicast System Messages

Unicast messages require the address of the master be entered into the Acceptable Master Table (AMT) in each slave. If there are multiple masters, the IP address for each master must be entered in the AMTs of all the slaves.

In Unicast PTP systems, the slave must have the address of the master in its acceptable master table because the slave initiates the communication with the master. The slave

sends several grant requests to the master requesting specific rates for each message type. If the master accepts the grant requests, it sends grant acknowledges. If the master denies the grant, the slave may send a new grant request at a lower rate. This process may continue for several iterations until the master and slave agree on a rate. The master and slave then start exchanging the PTP messages. If the master cannot support any of the rates requested by the slave, then the slave cannot lock to the master.

Mixed-Mode System Messages

In Mixed Mode systems, some messages are Multicast and some are Unicast. For the SMPTE ST2059 profile, the Announce and Sync messages are sent as Multicast. This allows devices to discover the active master. The Delay Request messages are configured as Unicast, in some case with negotiation, and in other cases without negotiation.

SMPTE Profile System Messages

For SMPTE profile systems, a given domain must use one type of message for all Announce, Sync, and Follow-up messages. Therefore, all masters and slaves on that domain must be configured for either Multicast or they all must be configured for Unicast.

For SMPTE mixed mode, the Announce, Sync, and Follow up messages are configured as Multicast, whereas the delay requests can be Multicast, Unicast, or Unicast without negotiation. To use this combination with an SPG8000A master clock generator, set the master and slave to any of the modes: Multicast, Mixed, or Mixed without negotiation. The masters support all of the slave modes simultaneously.

BMCA Operation

The Best Master Clock Algorithm (BMCA) is used to choose the active master on the domain. This is partially explained in the introduction to this document. The BMCA operation varies somewhat as function of communication mode.

Multicast Mode

In Multicast mode, the active master sends announce messages which all other masters and slaves can receive. So all devices can evaluate the BMCA and decide on the best master. If any device detects that its BMCA rating is better than the current master, it sends an announcement and takes over as the active master.

Unicast Mode

In Unicast mode, slaves only get Announce messages if they establish a grant from the master. Therefore, each slave must set up a grant with every device in its AMT. Since the masters do not set up grants from other masters, they do not have the information to evaluate the BMCA and know if they are the active master. It is up to the slaves to evaluate the BMCA based on the announce message they get from each master in their AMT. Each slave then decides which master is the best and then set up grants for the other message types. If slaves on a given network have a different list of masters in their AMT, then they may choose a different master.

Mixed Mode

In a SMPTE ST2059 mixed environment, the announce message is Multicast. Therefore, the BMCA can follow the Multicast conventions.

Compensating for Causes of Asymmetric Delay

Several factors can cause the PTP message delay to be different for the messages sent from the master to slave as opposed to the messages the other direction from the slave to master. Unless corrected, this propagation delay asymmetry causes an offset in the clock phase equal to $\frac{1}{2}$ the difference in the two path delays. There are several main causes of asymmetric delay:

- Rate mismatch in the ports on a switch
- Traffic mismatch on the two paths
- Message type mismatch
- Cable delay variation

This section contains suggestions on how to design the system to minimize the delay asymmetry. Alternatively, some slaves provide a way to manually enter a correction value to cancel the delay error.

Rate Mismatch

Rate mismatch in a switch causes a delay asymmetry because the switch performs a “store and forward” action on messages. This means the entire message must be stored in the buffer before it starts to be “forwarded” or sent out. For example, for a 100 Mb input and 1 Gb output, the switch must wait for the entire message to clock in at the slow rate before it can start outputting the message at the high rate. Conversely for a 1 Gb/s input and 100 Mb/s output, the entire packet is quickly read in at the faster rate, so then the output can start sooner but at a lower rate.

While the total time is the same for both directions, the delay on the fast-in, slow-out direction is shorter on the packets which contain the PTP time stamps. This effect is significant on a 100 Mb/1 Gb rate mismatch, but much less significant on a 1 G/10 G switch since the message time at 1 Gb/s is quite short. If the switch supports Transparent Clock (TC) mode, then this rate mismatch delay effect is corrected by the TC delay correction.

Traffic Mismatch

Another cause of asymmetric delay is traffic mismatch on the two paths. If there is a high percentage of traffic utilization on the master to slave path, then most of the PTP messages may be delayed significantly. If the traffic on the other direction is significantly different, then the messages on the path may not suffer the same delay.

This effect can be quite large depending on the traffic, the quality of the switch, and the number of switches in the network. To reduce this effect, a user should avoid large loading on the PTP network, use high-quality switches that avoid this delay variance, or use PTP Transparent mode switches which insert residence time information to allow the slave to correct for this delay.

Setting the Diff Serve QoS on the switch and configuring the PTP messages with an appropriate DSCP can also mitigate the effects of traffic delay.

Message Type Mismatch

Another cause of delay asymmetry is message type mismatch. For example, if the sync message is Multicast and the delay request is Unicast, then some switches may process the messages differently and cause a differential delay. Since the SMPTE profile allows a mixed mode operation, switches should be evaluated to ensure they do not have this effect. If transparent mode switches are used, then this effect should be corrected by the slave.

Cable Delay Variation

The actual propagation delay through Cat 5 cable can be significantly different in one direction versus the other direction. This can be due to the twist rate on the pairs, routing inside the sheath, material differences, etc. The PTP system is incapable of removing this effect, so the best way to prevent this is to use high-quality cable with a minimum variation in the physical propagation delay.

